

OUTDOOR THERAPY

EDITION 2020

Varaschin
OUTDOOR THERAPY

OUTDOOR
THERAPY

INDEX BY CHAPTER

- 004 FAMILY DAY
- 042 OUTDOOR COLLECTION
- 296 LOW COLLECTION
- 304 TEXTILE COLLECTION

INDEX BY CATEGORY

/ SEDUTE E SGABELLI SEATING AND STOOLS

- 254 CLEVER
- 042 EMMA
- 114 NOSS
- 142 SMART
- 192 VICTOR

/ POLTRONE E DIVANI ARMCHAIRS AND SOFAS

- 286 BENTO
- 232 BALI BERGÈRE DECK RELAX
- 254 CLEVER
- 042 EMMA
- 142 SMART

/ LETTINI SUNBEDS

- 244 BAHIA
- 042 EMMA
- 192 VICTOR

/ TAVOLI TABLES

- 214 PLINTO
- 100 SYSTEM
- 084 SYSTEM STAR
- 192 VICTOR

/ TAVOLI LOW LOW TABLES

- 214 PLINTO
- 100 SYSTEM
- 192 VICTOR

INDEX BY COLLECTION

- 244 BAHIA
- 286 BENTO
- 232 BALI BERGÈRE DECK RELAX
- 254 CLEVER
- 042 EMMA
- 114 NOSS
- 214 PLINTO
- 142 SMART
- 100 SYSTEM
- 084 SYSTEM STAR
- 172 TIBIDABO
- 192 VICTOR



042 EMMA

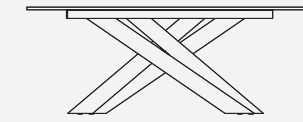

084 SYSTEM STAR



100 SYSTEM



114 NOSS



142 SMART

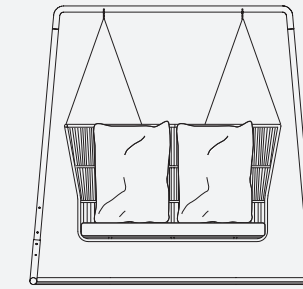

172 TIBIDABO

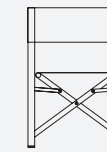

192 VICTOR



214 PLINTO

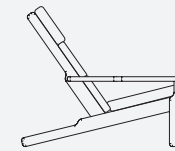

232 BALI BERGÈRE DECK RELAX

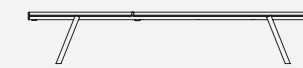

244 BAHIA

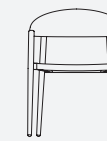

254 CLEVER

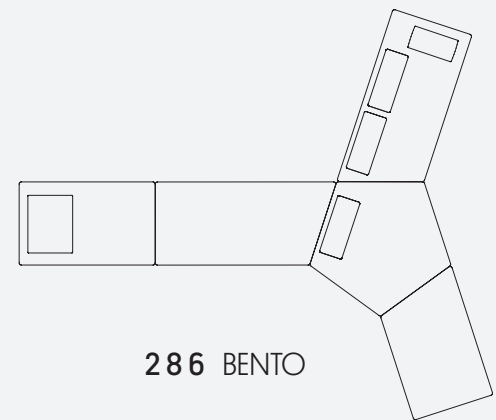

286 BENTO



FAMILY DAY

OUTDOOR THERAPY STORIES

Amiamo la pace e la natura del lago, un luogo di verità.
Un piccolo mare di acqua dolce dove tutto sembra regolato da un ritmo speciale.
Il lago è uno specchio sincero e mentre noi disponiamo la vita
con atti di estrema vanità ed orgoglio,
non ci accorgiamo delle cose semplici, come la natura che ci circonda.
Amiamo la natura, vogliamo viverla e rispettarla per le opportunità che ci offre.
Libertà e benessere, purezza ed armonia rappresentano un modello di comportamento
che ogni giorno fa parte del nostro rituale.

*We love the peace and nature of the lake, a place of truth.
A small sea of fresh water where everything seems to be regulated by a special rhythm.
The lake is a sincere mirror and while we arrange life with acts of extreme vanity and pride,
we do not notice simple things, like the nature that surrounds us.
We love nature, we want to live it and respect it for the opportunities that it offers us.
Freedom and wellbeing, purity and harmony represent a behavior model
which is part of our everyday ritual.*

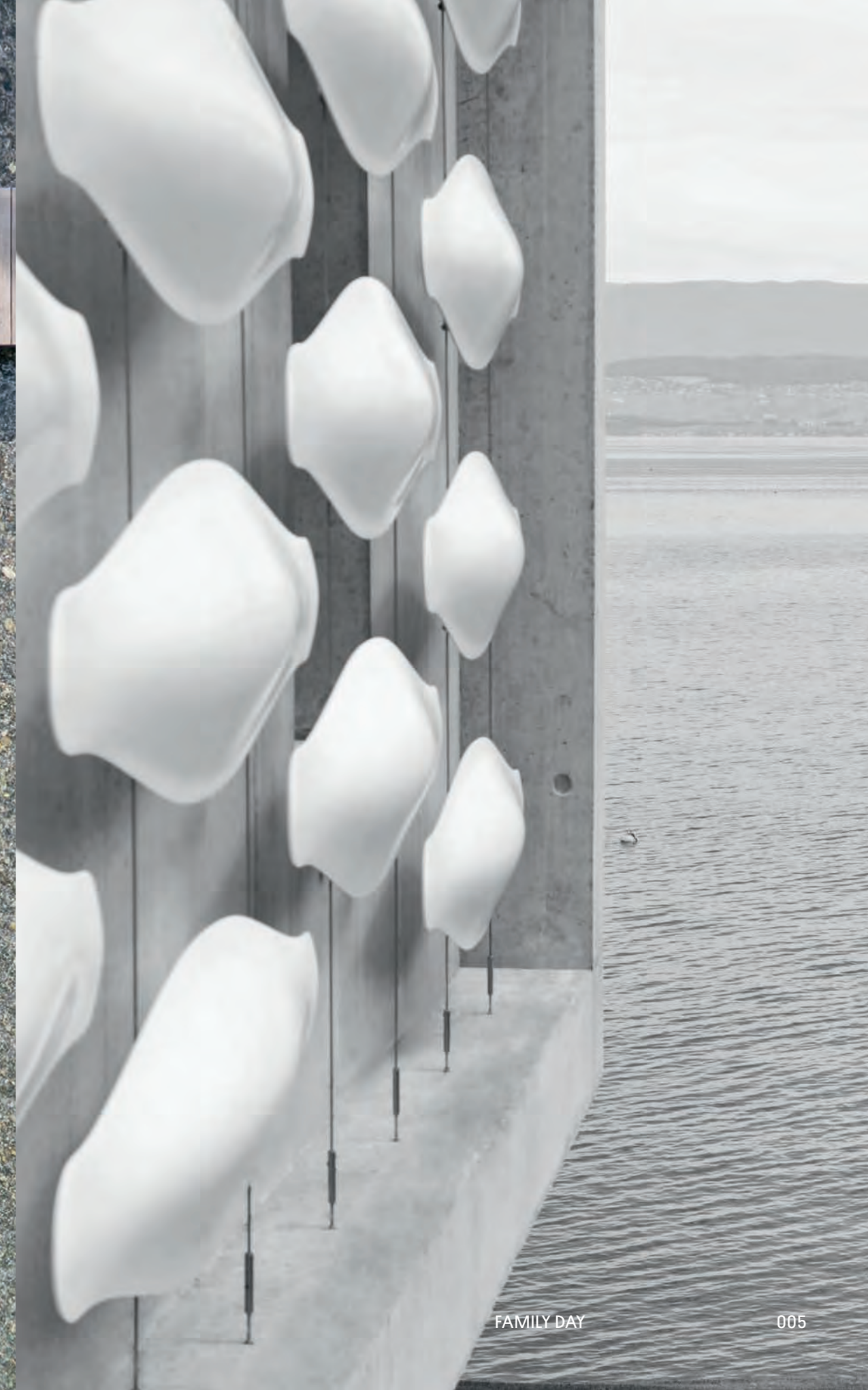

SUNRISE INSPIRED

I riflessi del nuovo giorno sulla superficie dell'acqua sono il paesaggio di ispirazione che preferisco. Comincio sempre la mia giornata apprezzando i colori speciali di questo momento magico ed intimo che risveglia la vita.

Reflections of a new day on the surface of water are my favorite inspirational landscape. I always start my day appreciating special colors of this magical and intimate moment that awakens life.





JUICY MORNING

La colazione è sempre il momento migliore per qualcosa di succoso, dolce e fresco, sembra proprio il modo giusto per iniziare la giornata. Preferisco sempre il colore abbinato ai sapori autentici così la nostra tavola è allegra, giocosa ed anche sana.

Breakfast is always the best moment for something juicy, sweet and fresh it really seems the right way to start the day. I always prefer color combined with authentic flavors so our table is cheerful, playful and also healthy.





COZY MEETING

Ci sono due cose che desidero trasmettere ai miei figli: le radici e le ali. Quando faranno le domande risponderò, quando ci saranno i dubbi gli farò sapere come risolverli. Ma la libertà di pensiero è come vivere all'aperto, non ci sono confini nei paesaggi come non c'è limite al desiderio di realizzazione.

There are two things that I want to pass on to my children: roots and wings. When they ask questions I will answer, when they have doubts I'll explain how to solve them. But freedom of thought is like living outdoors, there are no boundaries in the landscapes as there is no limit to desire of realization.





HOME OUT

Ho le mie personali convinzioni e valori,
e vivo per quelli.
Ma come artista, come fotografo ritrattista,
il mio lavoro è dire la verità
e catturare lo spirito di qualcuno
in un determinato giorno.
Quando le parole non sono chiare,
mi concentro sulle fotografie.
Quando le immagini diventano inadeguate,
mi accontenterò del silenzio.

*I have my personal beliefs and values,
and I live for those.
But as an artist, as a portrait photographer,
my job is to tell the truth
and capture someone's spirit
on a certain day.
When words are not clear,
I focus on photographs.
When images become inadequate,
I will be content with silence.*





TOGETHERNESS

Una delle cose più belle della giornata è il modo in cui dobbiamo interrompere regolarmente tutto ciò che stiamo facendo per stare insieme. Il pranzo è un intreccio di cucchiari, sorrisi, gesti, ed anche qualche ricordo.

One of the most beautiful things of the day is the way in which we have to regularly stop what we're doing to be together. Lunch is a mix of spoons, smiles, gestures, and also memories.





SUNNY LAKESIDE

La luce può essere delicata, pericolosa, onirica, nuda, nebbiosa, calda, primaverile, calma e morbida.

Ma la luce è generosa, si dona liberamente, riempiendo tutto lo spazio disponibile.

Non cerca nulla in cambio; non chiede se si è amici o nemici, il mio mondo perfetto è luminoso.

Light can be delicate, dangerous, dreamlike, naked, misty, hot, vernal calm and soft.

But light is generous, it gives itself freely, filling all available space.

It looks for nothing in return; it does not ask if you are friends or enemies, my perfect world is bright.





PLAY TIME

I bambini hanno delle regole del gioco
innocenti e serie.
L'aria aperta suggerisce una creatività
che mantiene attiva la mente
ed è il sano fenomeno sociale che non finge nulla.
Forse la vita è l'unico gioco
in cui il gioco stesso è impararne le regole.

*Kids have innocent and serious rules of the game.
Open air suggests creativity
which keeps the mind active
and it is the healthy social phenomenon
that does not pretend anything.
Maybe life is the only game
where the game itself is learning the rules.*





CHILL OUT

Il momento della confidenza a fine giornata
è un attimo speciale,
il verde diventa più serio,
la brezza si è spenta,
la calma del lago diventa una cassa di risonanza pura,
in cui i dettagli prendono vita,
e le nostre azioni quotidiane diventano storia.

*The moment of confidence at the end
of the day is a special moment,
green becomes more serious, the breeze dies down,
the calm of the lake becomes a pure sounding board,
where details come to life,
and our daily actions become history.*





PRIVACY TIME

Si pianifica tutto,
ma la sera è il momento della casualità,
la notte che arriva
è come la cornice di un quadro,
dipinge un giorno incredibile,
o magari complicato,
ma non vorremmo che finisse mai
perché qui fuori tutto è una poesia,
lasciamo che tutto accada
secondo i ritmi della natura.

*Everything is planned
but the evening is the moment of randomness,
the night that comes
is like a picture frame,
it paints an incredible day,
or maybe complicated,
but we wouldn't want it to ever end
because here everything is a poem,
we let it all happen
according to the rhythms of nature.*





EMMA

DESIGN MONICA ARMANI

Collezione di sedute outdoor con soluzioni di gambe sia in alluminio che iroko massello. Tappezzeria della seduta in tessuto e imbottitura con gomme Dryfeel da esterno. Schienali con telai di alluminio verniciati a polveri e intrecciati a mano.

La collezione comprende anche tavolini outdoor con soluzioni di gambe sia alluminio che iroko sia alluminio che iroko sia alluminio che iroko sia alluminio che iroko.

MODELLO REGISTRATO

Collection of outdoor seating. Legs available in iroko wood and aluminum extrusion. Seat upholstered with fabric and outdoor Dryfeel foam.

Back with aluminum frame, hand-woven and powder coated.

Collection of outdoor tables with aluminium and iroko wood legs.

Hpl and ceramic tops.

REGISTERED MODEL

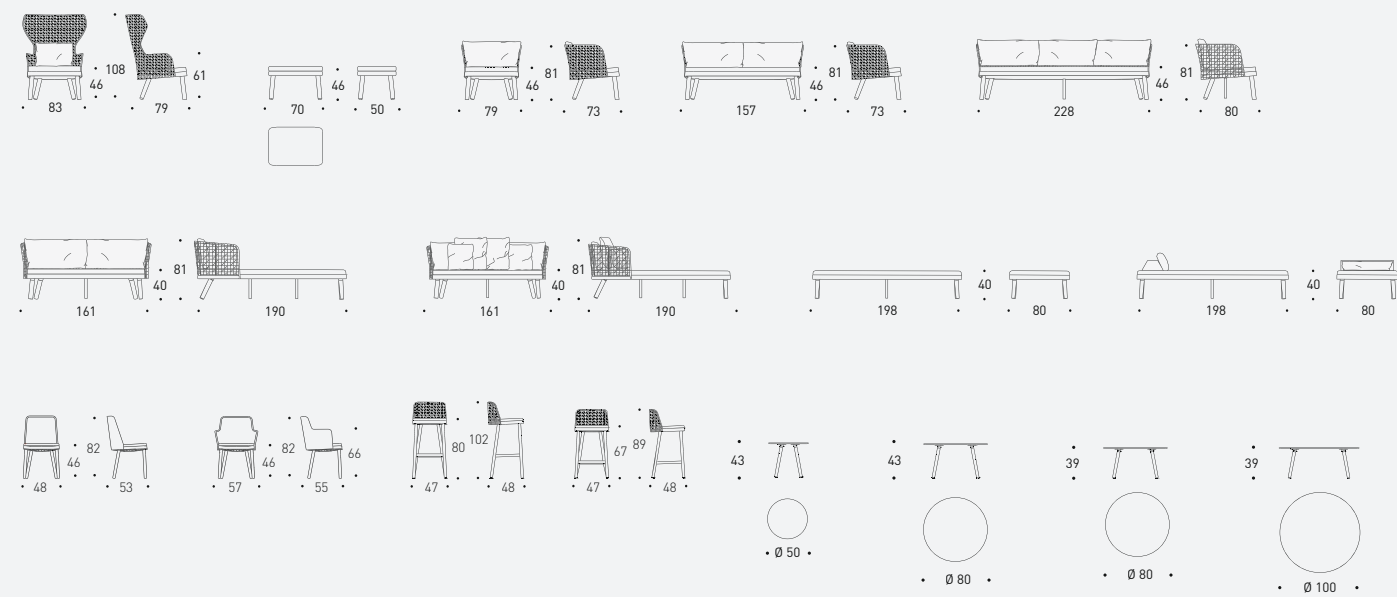

























POLTRONCINE EMMA - TAVOLO SYSTEM STAR / EMMA ARMCHAIRS - SYSTEM STAR TABLE



COLLEZIONE EMMA - TAVOLO SYSTEM STAR / EMMA COLLECTION - SYSTEM STAR TABLE



POLTRONCINE EMMA - TAVOLO SYSTEM STAR / EMMA ARMCHAIRS - SYSTEM STAR TABLE



POLTRONCINE EMMA - TAVOLO SYSTEM STAR / EMMA ARMCHAIRS - SYSTEM STAR TABLE



POLTRONCINE EMMA - TAVOLO PLINTO / EMMA ARMCHAIRS - PLINTO TABLE



SGABELLI EMMA - TAVOLO PLINTO / EMMA STOOLS - PLINTO TABLE



SGABELLI EMMA - TAVOLO PLINTO / EMMA STOOLS - PLINTO TABLE



IROKO

ALLUMINIO BIANCO
WHITE ALUMINIUM



VAR#ROPE BEIGE

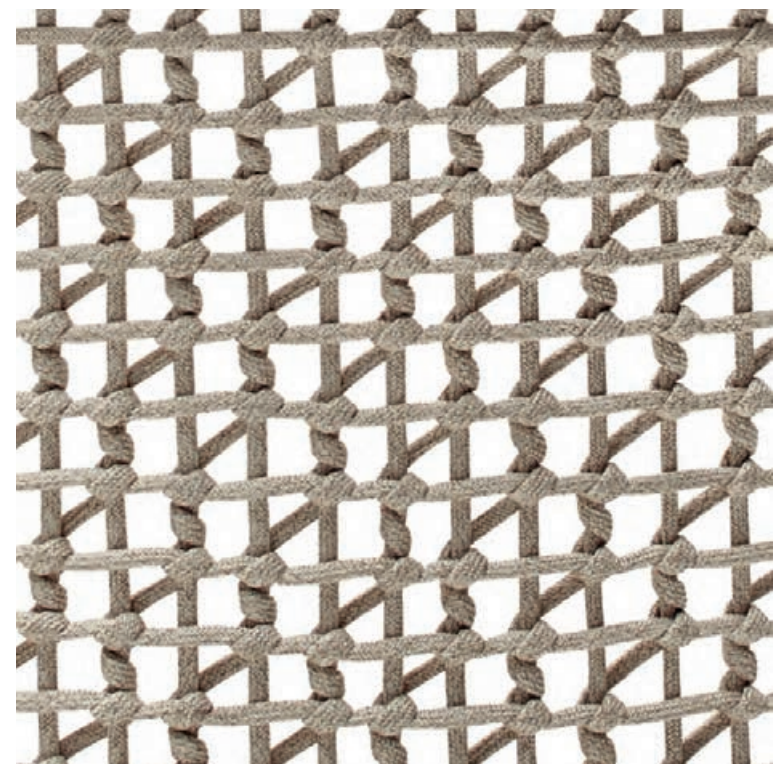

LOPEZ MARMO



EMMA STYLE MOOD

VOGUE NATTE



CERAMICA BOCCIARDATA BIANCO CALCE
BUSH-HAMMERED CERAMIC LIME WHITE

MARINE BEIGE





MONICA ARMANI TALKS ABOUT EMMA

Amo definire il mio design come una sorta di processo molecolare.

Per la collezione Emma ho creato le mie molecole per il progetto: segno e manifattura dell'intreccio, dettagli raffinati, definizione attenta delle proporzioni, un pizzico di heritage per un progetto/collezione assolutamente lasting.

Muovendomi nel DNA di Emma ho creato i nuovi oggetti per il relax, una raffinata dormeuse e un accogliente daybed.

La collezione Emma, fedele al suo DNA, cresce di anno in anno sempre più protagonista dell'outdoor therapy di Varaschin.

I love to define my design as a sort of molecular process. For the Emma collection, I created the project molecules: weaving design and manufacturing, refined details, careful definition of proportions, a bit of heritage for a lasting project/collezione.

Moving into Emma's DNA, I created new objects for relaxation, a refined dormeuse and a cozy daybed.

The Emma collection, true to its DNA, grows more and more protagonist every year of Varaschin outdoor therapy.

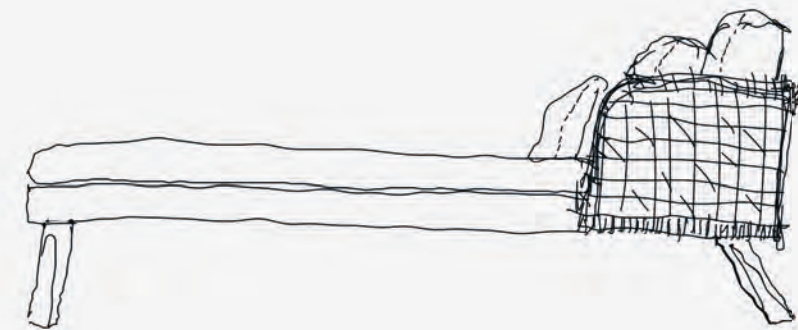
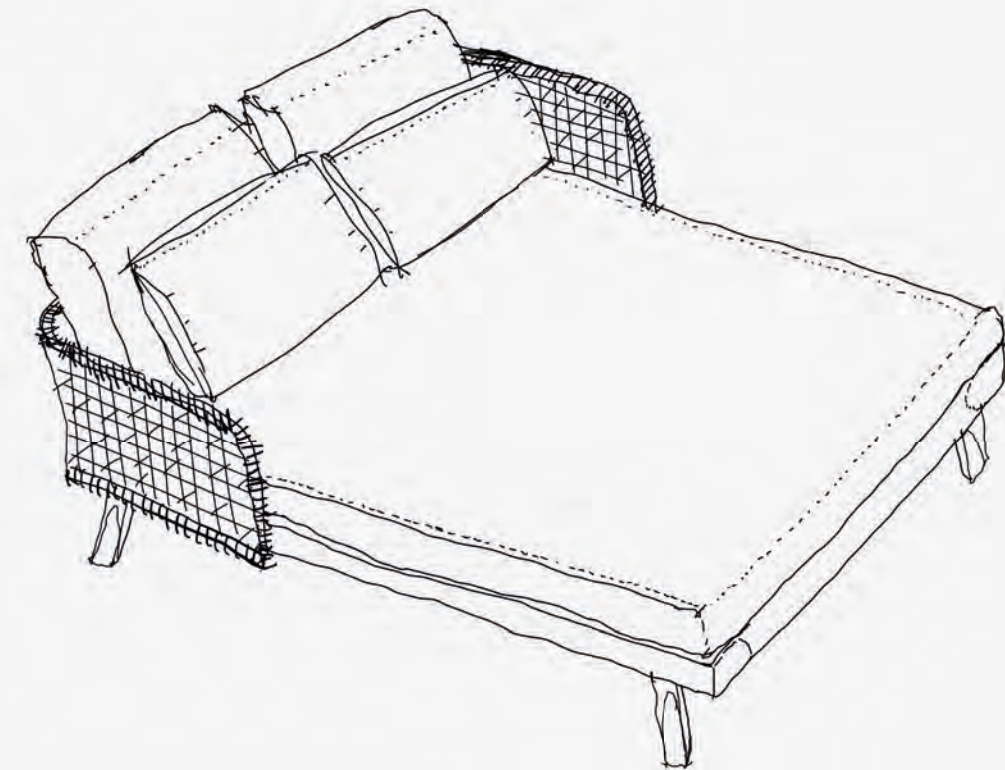
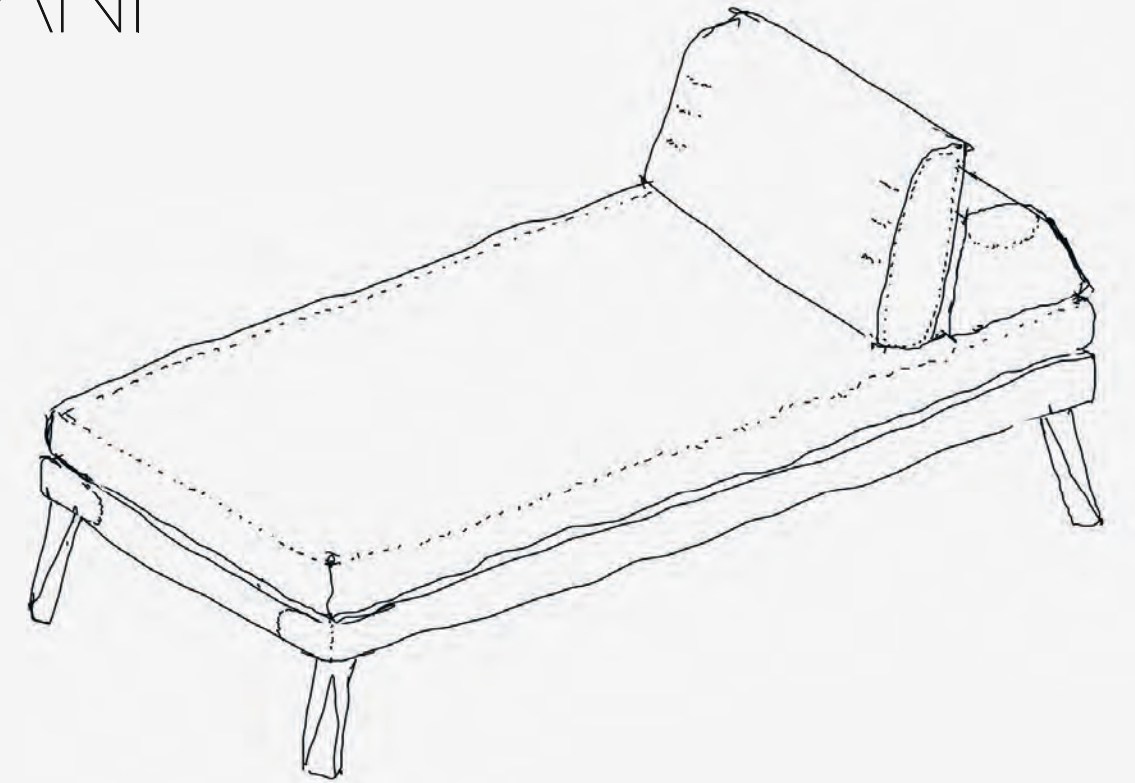

COLLECTION

SYSTEM STAR

DESIGN DANIELE LO SCALZO MOSCHERI

Collezione di tavoli fissi con struttura in alluminio verniciato a polveri e top rettangolari ed ellittici in Hpl o ceramica.

REGISTERED MODEL

Fixed tables with powder coated aluminum structure and rectangular or elliptic tops, available in HPL or ceramic.

REGISTERED MODEL

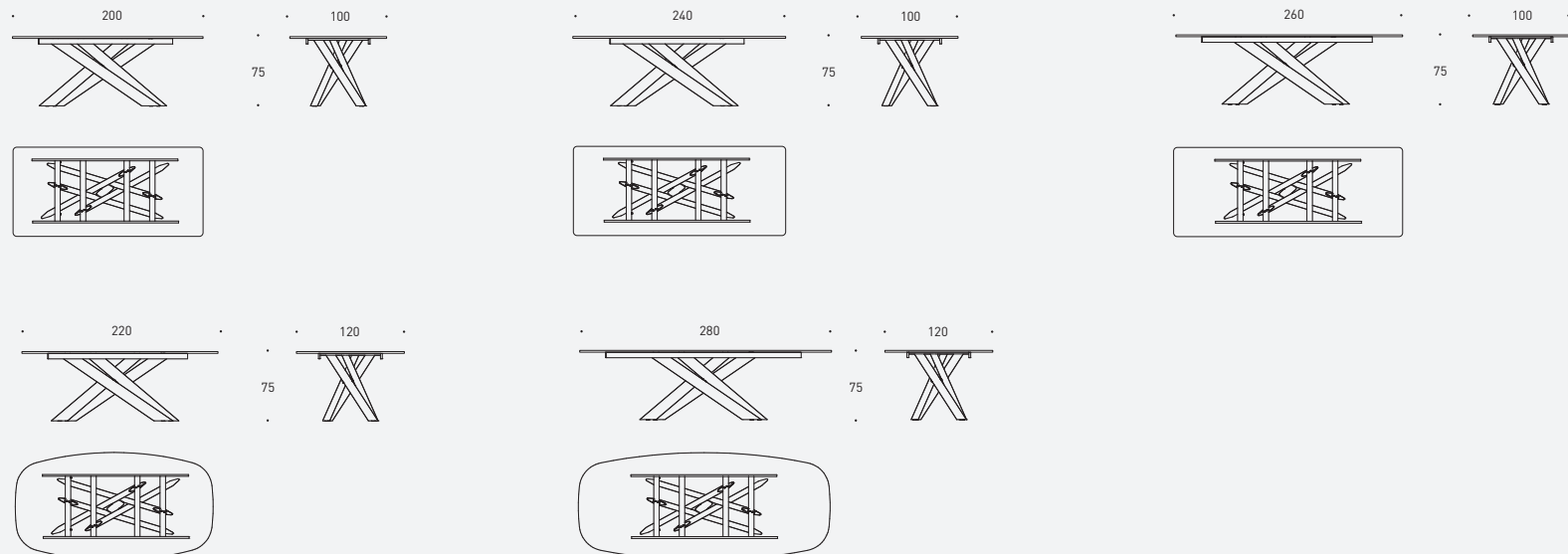

Altezza riferita con top Hpl e ceramica / Height reported with Hpl and ceramic top.





POLTRONCINE NOSS - TAVOLO SYSTEM STAR / NOSS ARMCHAIRS - SYSTEM STAR TABLE





POLTRONCINE SUMMER SET - TAVOLO SYSTEM STAR / SUMMER SET ARMCHAIRS - SYSTEM STAR TABLE



POLTRONCINE NOSS - TAVOLO SYSTEM STAR / NOSS ARMCHAIRS - SYSTEM STAR TABLE



POLTRONCINE EMMA - TAVOLO SYSTEM STAR / EMMA ARMCHAIRS - SYSTEM STAR TABLE

VEGETAL ORANGE

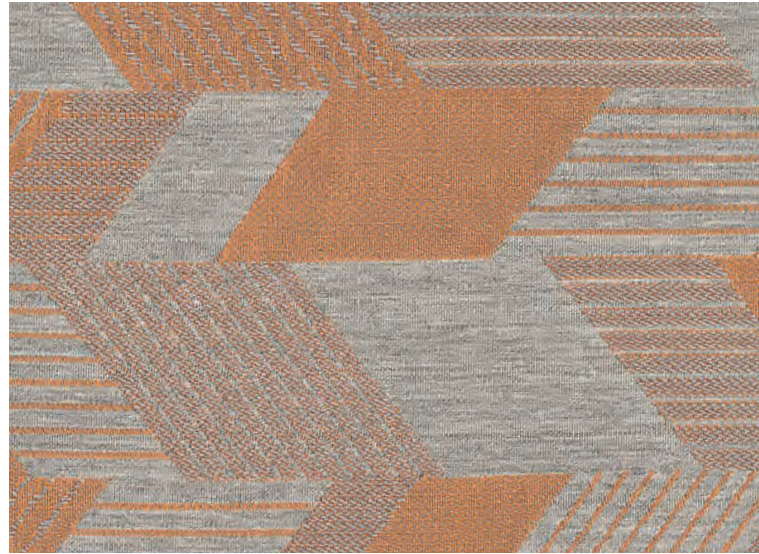

SYSTEM STAR STYLE MOOD



MARINE SACCO



HPL BEDONIA



ALLUMINIO BRONZO
BRONZE ALUMINIUM

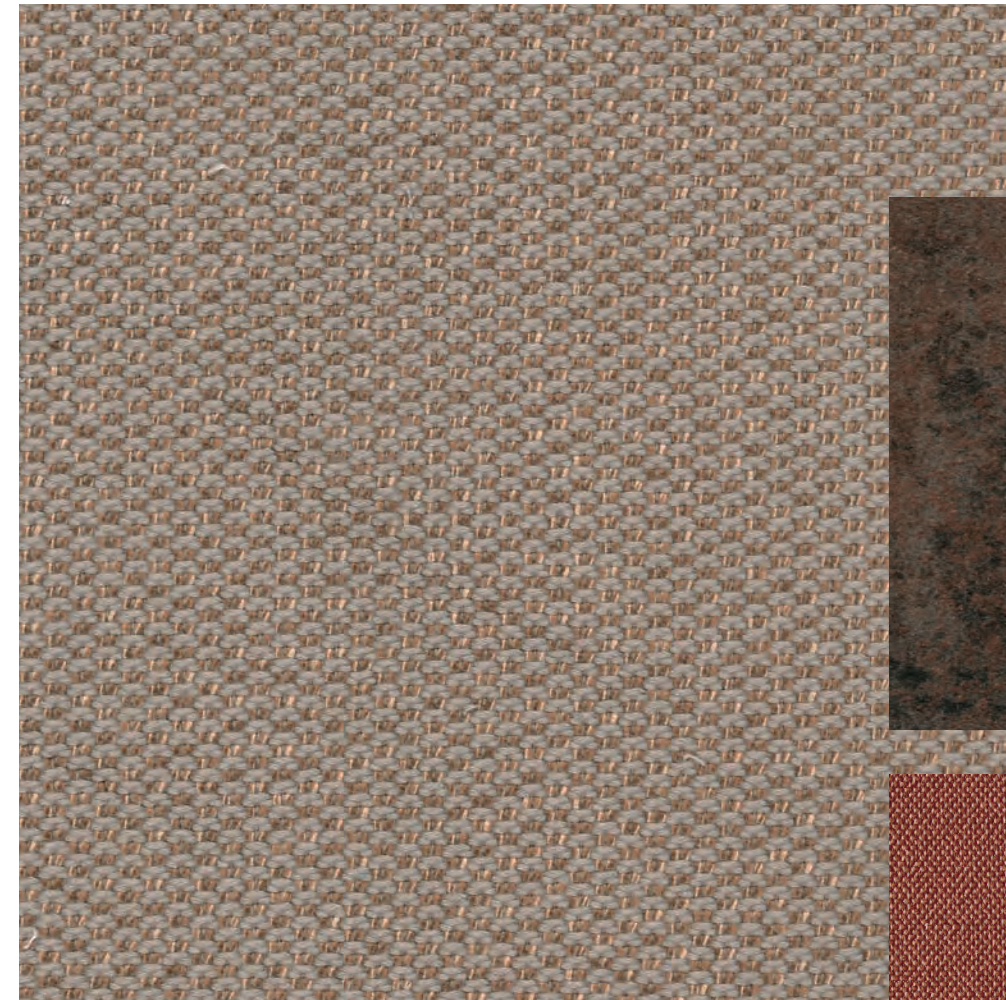

LOPEZ CANAPA



HPL CORTEN

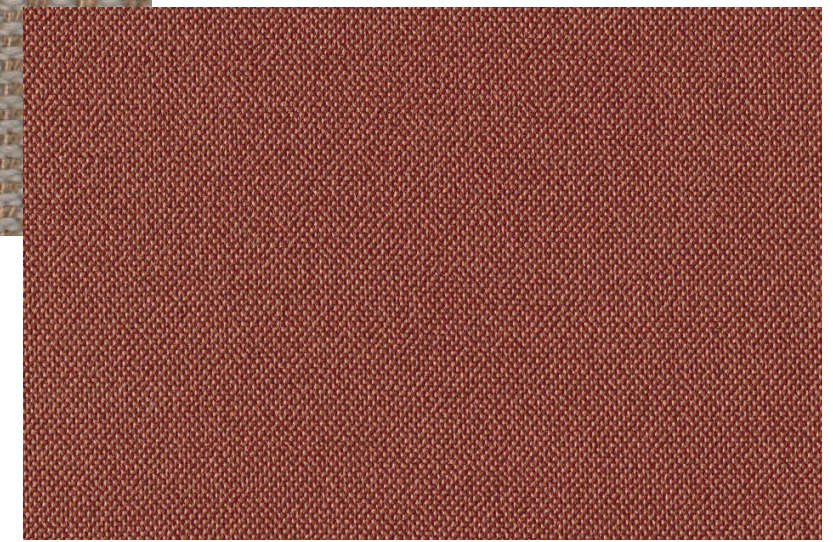

ABACO BRONZO



DANIELE LO SCALZO MOSCHERI TALKS ABOUT STAR

Star nasce da una curiosità banale, il riflesso di una stella, ma anche un cristallo di neve, quante volte ho osservato il cielo. La curiosità nell'ammirare la natura, sembra un processo scontato ma non lo è. Mi ispira e basta. Il tavolo Star è la naturale evoluzione della collezione System, il segno romboidale delle gambe che descrive il programma di panche e sedute si intreccia in un gioco di linee, di pieni e vuoti, dalla presenza leggera e caratterizzante.

"Star" stems from a trivial curiosity, the reflection of a star, of a snow crystal. I've looked at the sky so many times. The curiosity in admiring nature seems a foregone process, but it's not. It just inspires me. Star table is the natural evolution of the System collection; the rhomboidal shape of the legs describes a collection benches and seats intertwined in a play of lines, full and empty, with a light but characterizing presence.

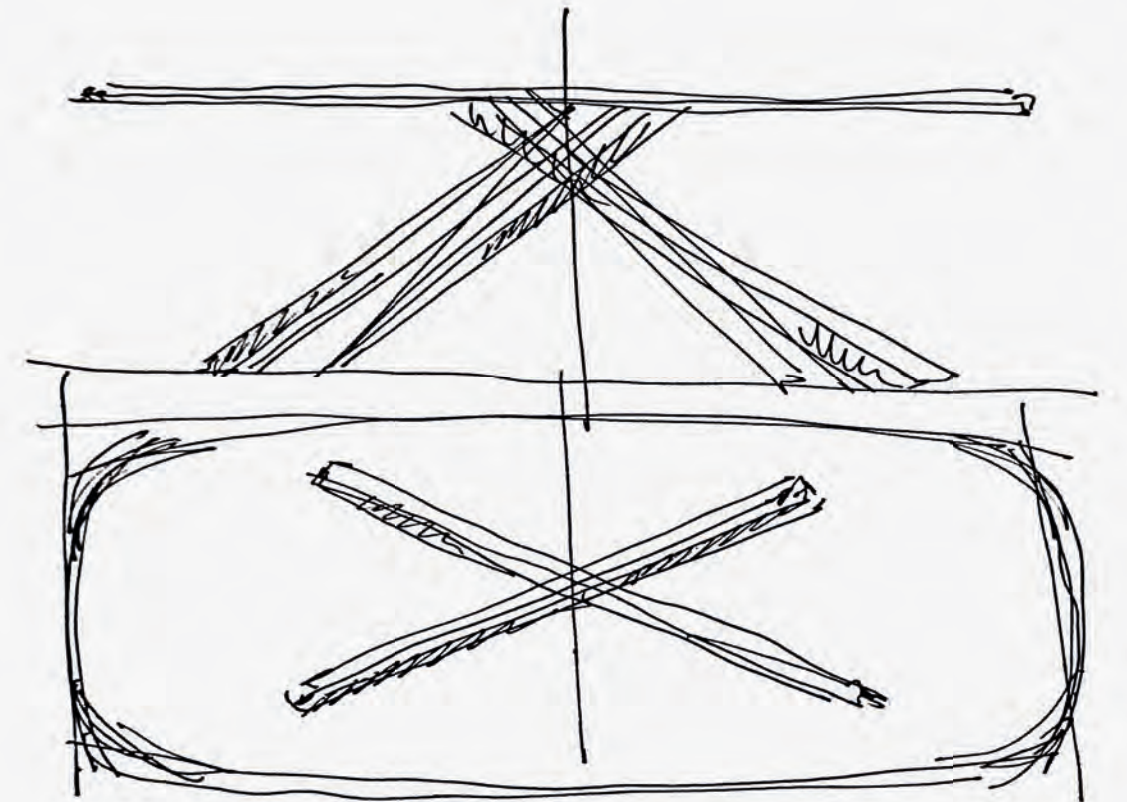
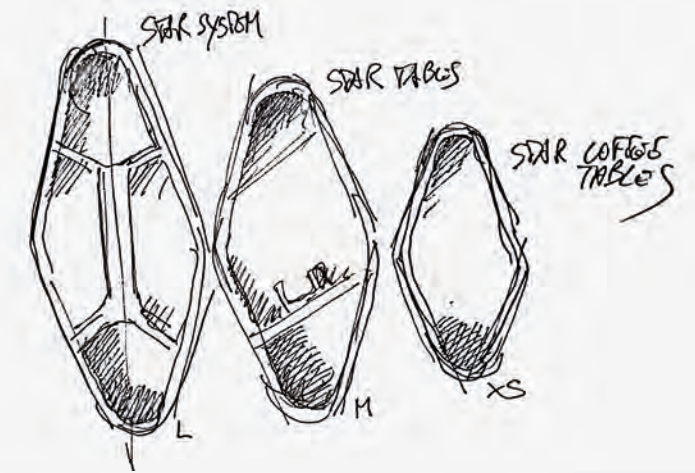

SYSTEM

DESIGN DANIELE LO SCALZO MOSCHERI

Collezione di tavoli, tavolini e panche con struttura in alluminio verniciato a polveri con top in Hpl o Ceramica.
Panca disponibile anche imbottita o con seduta in teak di piantagione certificata [solo 178x45].

MODELLO REGISTRATO

Collection of tables, coffee tables and benches with aluminum structure, powder coated, Hpl or ceramic top. Padded bench is also available or with teak seat from certified plantation. [only 178x45]

REGISTERED MODEL

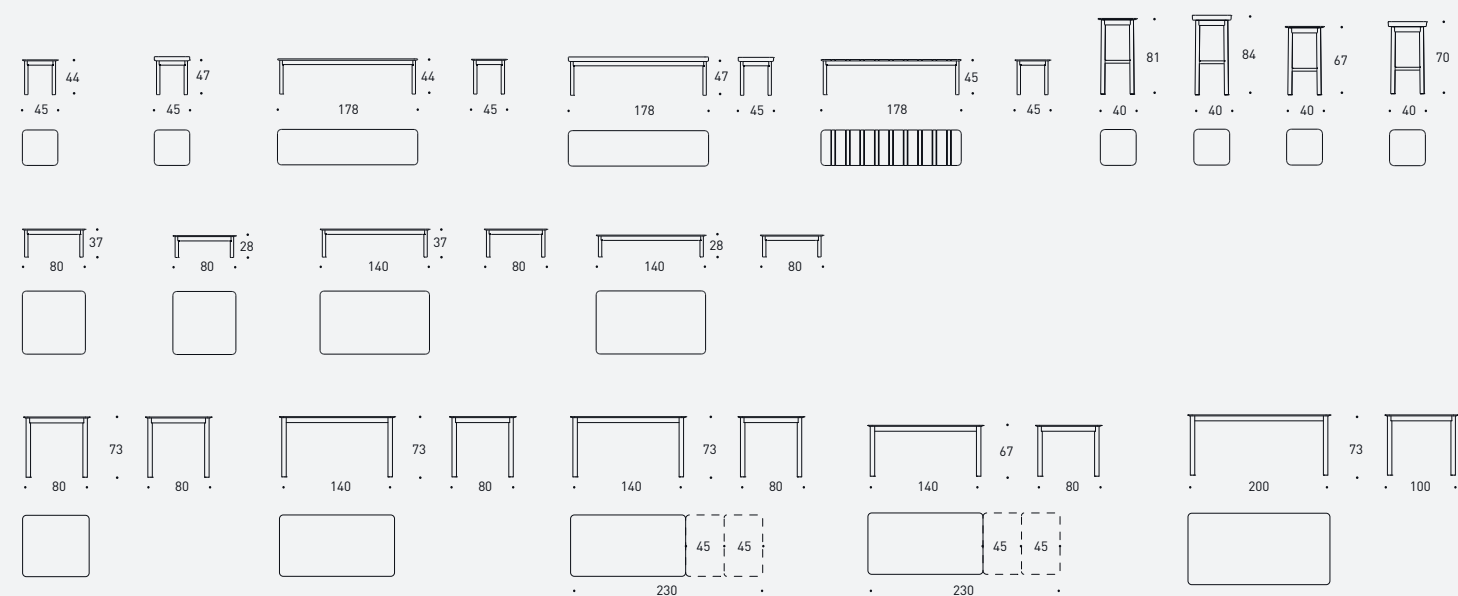

Altezza riferita con top Hpl e ceramica / Height reported with Hpl and ceramic top.





POLTRONCINE CLEVER - TAVOLO SYSTEM / CLEVER ARMCHAIRS - SYSTEM TABLE



POLTRONCINE CLEVER - TAVOLO SYSTEM - SDRAIO CLEVER / CLEVER ARMCHAIRS - SYSTEM TABLE - CLEVER FOLDABLE DECKCHAIRS

/SYSTEM ALLUNGABILE
EXTENDIBLE TABLE

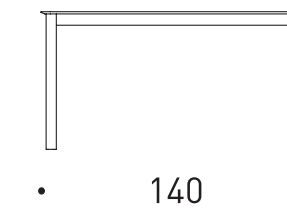
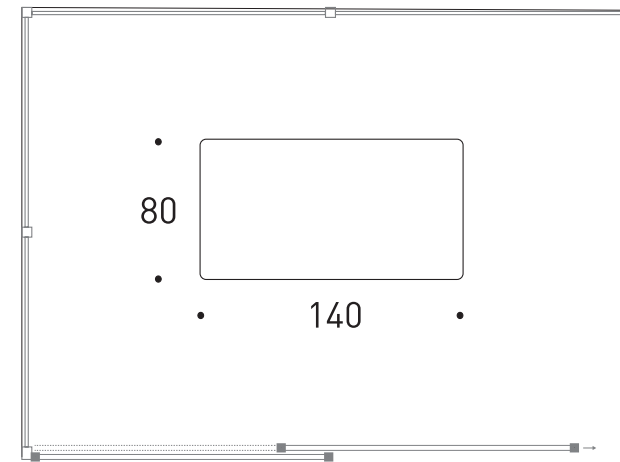

/ SYSTEM 140

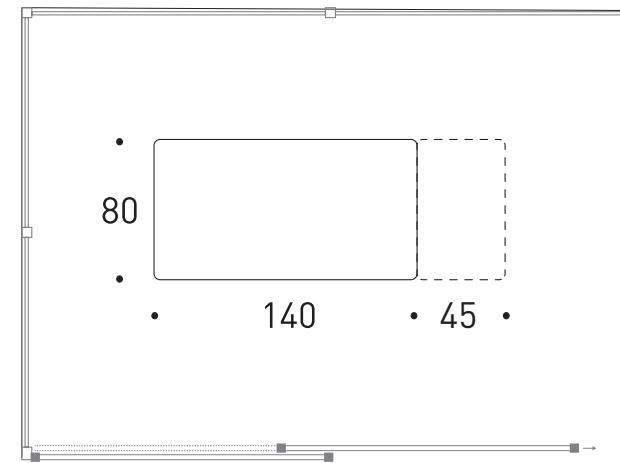

/ SYSTEM 185

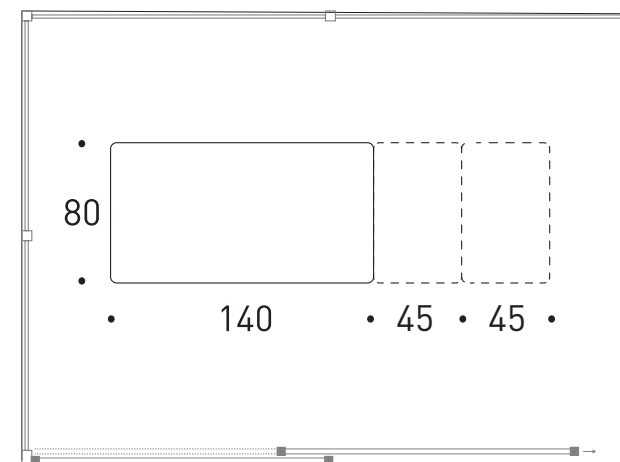

/ SYSTEM 230



POLTRONCINE NOSS - TAVOLO SYSTEM / NOSS ARMCHAIRS - SYSTEM TABLE





COLLECTION

NOSS

DESIGN EDOARDO GHERARDI

Poltroncina con struttura in tubo di alluminio e sedile in lamiera di alluminio spessore 15/10 verniciati a polveri. Schienale intrecciato a mano con corda in fibra sintetica (polipropilene) Light o Brown Line. Cuscino opzionale con imbottitura in gomma Dryfeel da esterno.

MODELLO REGISTRATO

Armchair with aluminum tube frame and seat in powder-coated aluminum sheet, 15/10 thick. Hand woven back with synthetic fiber rope (polypropylene) Light Line or Brown Line.

Optional cushion with Dryfeel foam padding for outdoor use.

REGISTERED MODEL

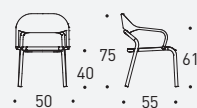
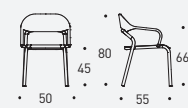



POLTRONCINE NOSS - TAVOLO SYSTEM STAR / NOSS ARMCHAIRS - SYSTEM STAR TABLE





POLTRONCINE NOSS - TAVOLO ELLISSE / NOSS ARMCHAIRS - ELLISSE TABLE



POLTRONCINE NOSS - TAVOLO ELLISSE / NOSS ARMCHAIRS - ELLISSE TABLE



/ NOSS LOW H40



/ NOSS H45

/ SYSTEM H 73

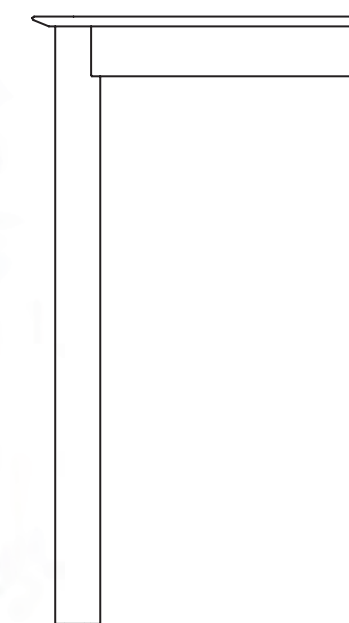

/ SYSTEM LOW H 67

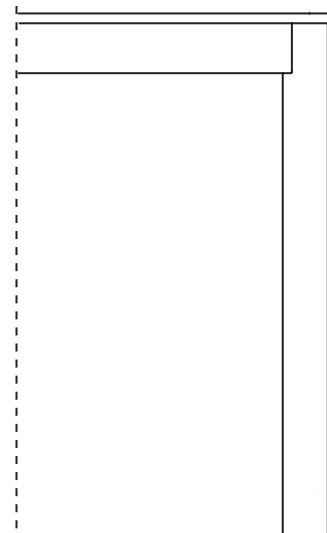

/ NOSS LOW H40

POLTRONCINE NOSS - TAVOLO PLINTO / NOSS ARMCHAIRS - PLINTO TABLE

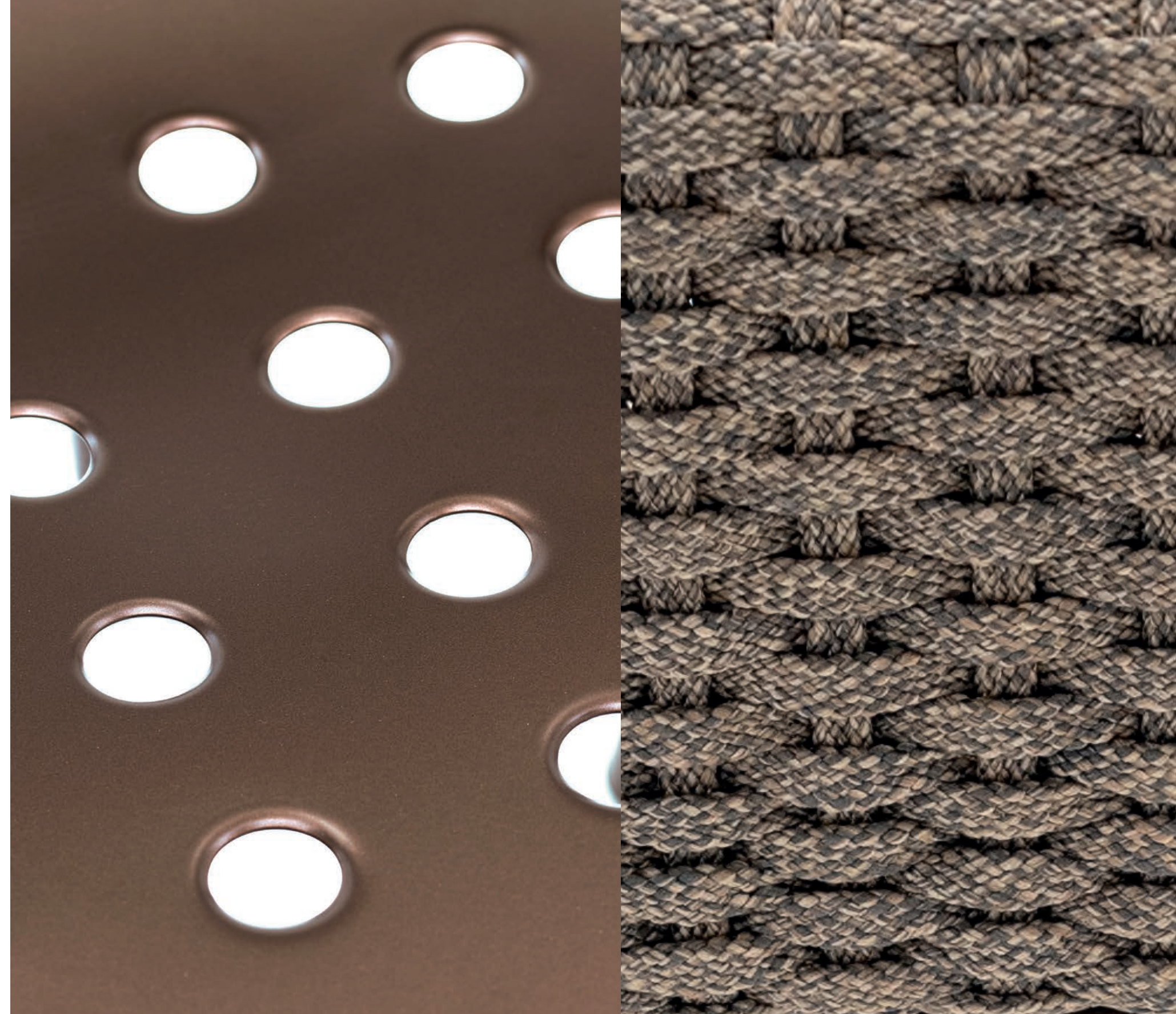





POLTRONCINE NOSS - TAVOLO SYSTEM STAR / NOSS ARMCHAIRS - SYSTEM STAR TABLE

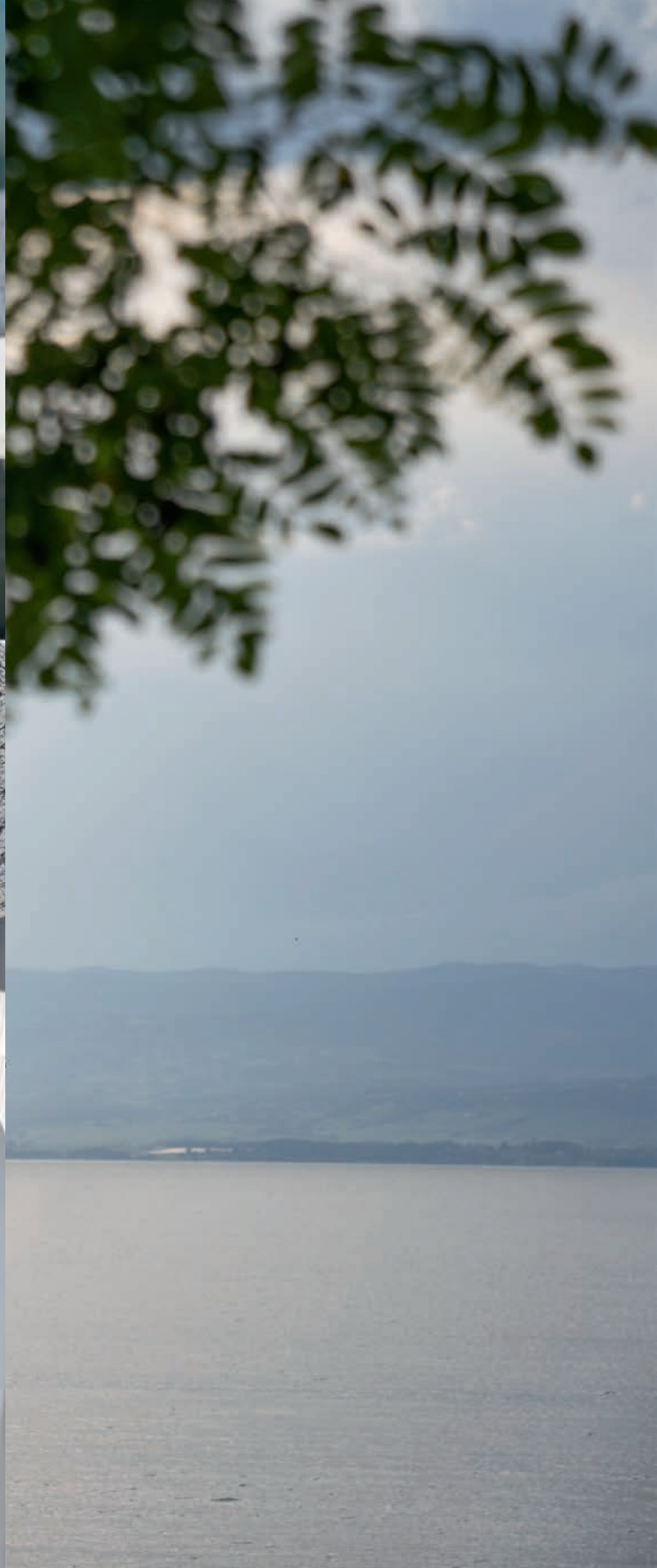

POLTRONCINE NOSS - TAVOLO ELLISSE / NOSS ARMCHAIRS - ELLISSE TABLE



POLTRONCINE NOSS - TAVOLI PLINTO / NOSS ARMCHAIRS - PLINTO TABLES



STRIPES BEIGE

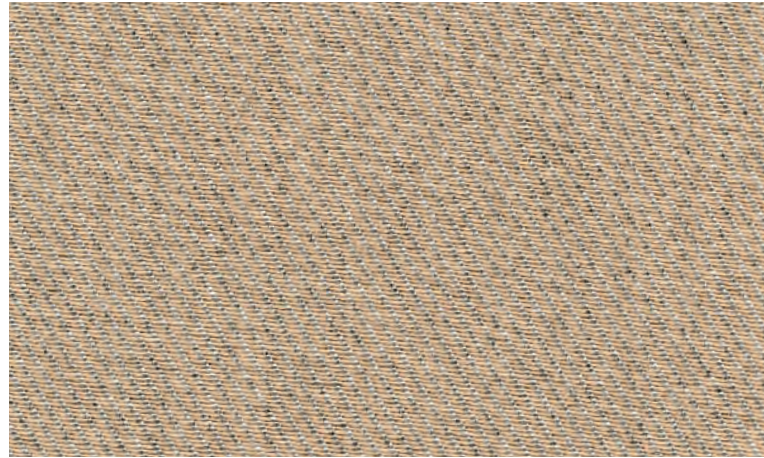

PIPER LINO

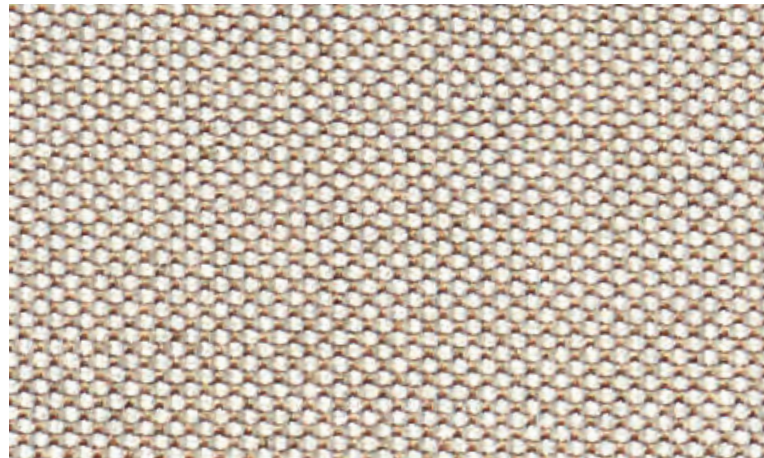

ALLUMINIO BRONZO
BRONZE ALUMINIUM



VEGETAL PIETRA

NOSS
STYLE MOOD

BROWN LINE

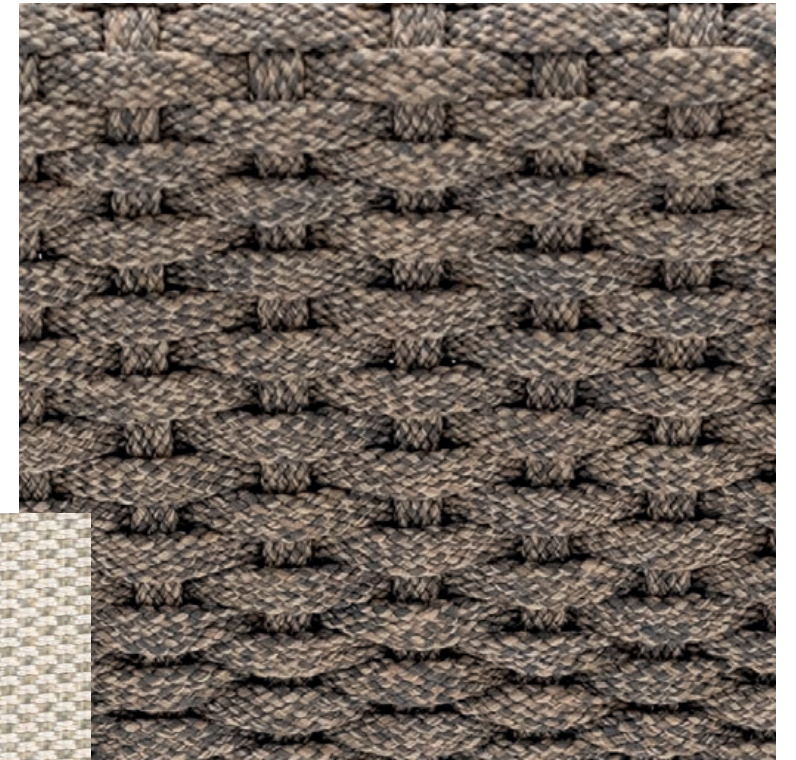

LOPEZ MARMO

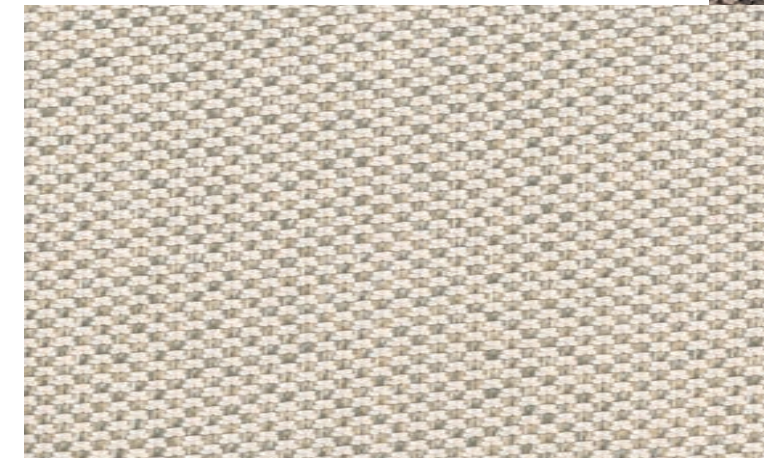

PASHMINA ALPACA



HPL CORTEN

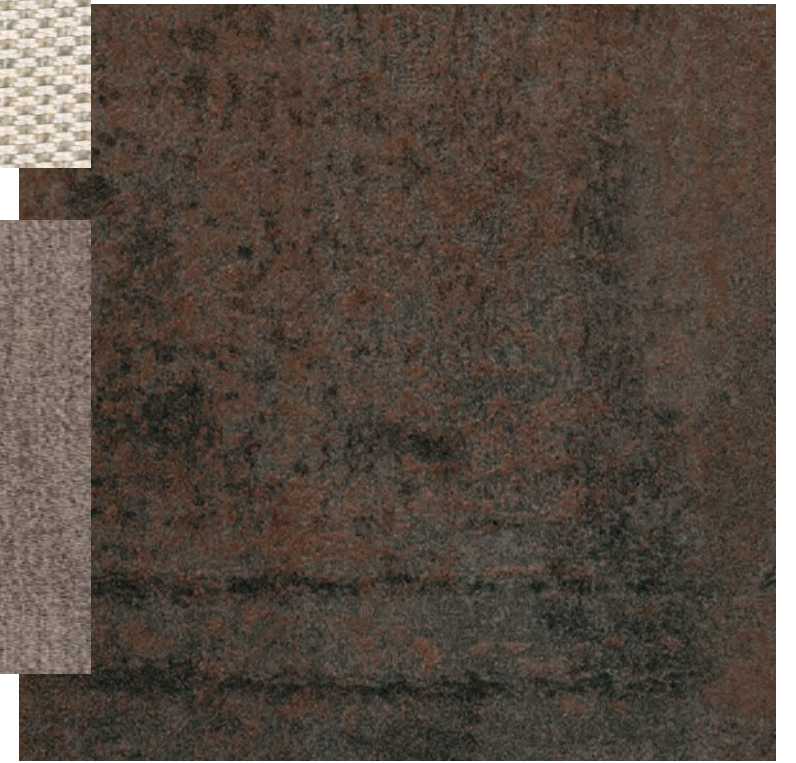



EDOARDO GHERARDI TALKS ABOUT NOSS

Composta di parti distinte ma tra loro corrispondenti e armonicamente disposte, Noss unisce tecnologia e innovazione.

Un nastro strutturale armonioso e leggero, ma al contempo robusto ed avvolgente, caratterizza il progetto in un perfetto equilibrio fra le parti in cui linee morbide e accoglienti abbracciano robustezza e solidità.

Per Noss il bilanciamento tra comodità, funzionalità e ricerca di un design innovativo, si unisce a materiali tecnologicamente avanzati in una alchimia di forme e funzioni, le quali trovano la massima valorizzazione nell'antica esperienza delle lavorazioni ad intreccio, caratterizzando fortemente questa seduta nata da un'esigenza di unire la tradizione e rinnovamento.

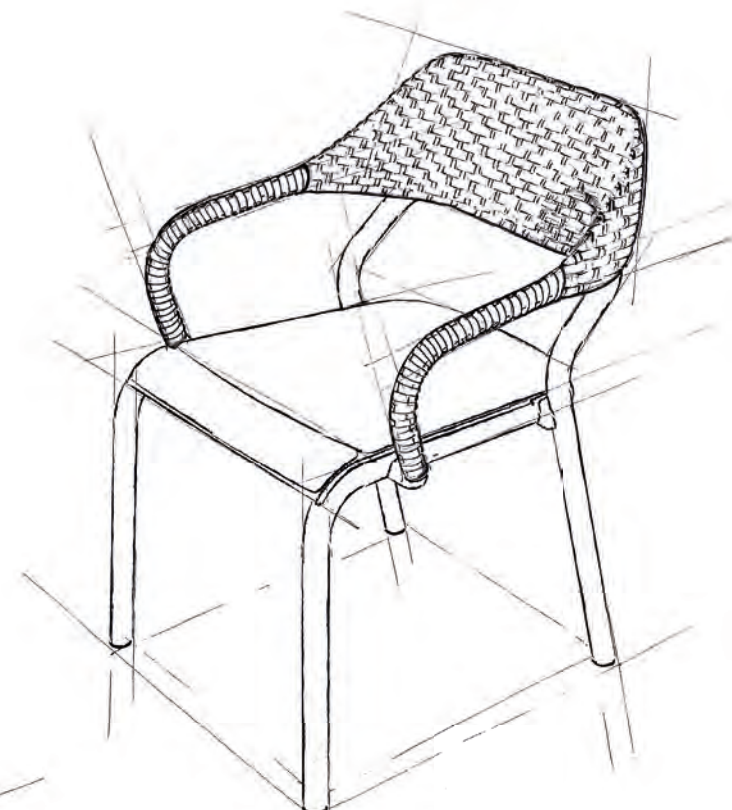

Composed of distinct but corresponding parts harmoniously arranged, Noss, combines technology and innovation. A structural rope, harmonious and light, but at the same time robust and enveloping, characterizes the project in a perfect balance between the parts in which soft and welcoming lines embrace strength and solidity.

For Noss, the balance between comfort, functionality and research for an innovative design joins technologically advanced materials in an alchemy of shapes and functions, which find the maximum value in the ancient experience of weaving, strongly characterizing this seat born from a need to combine tradition and modernity.

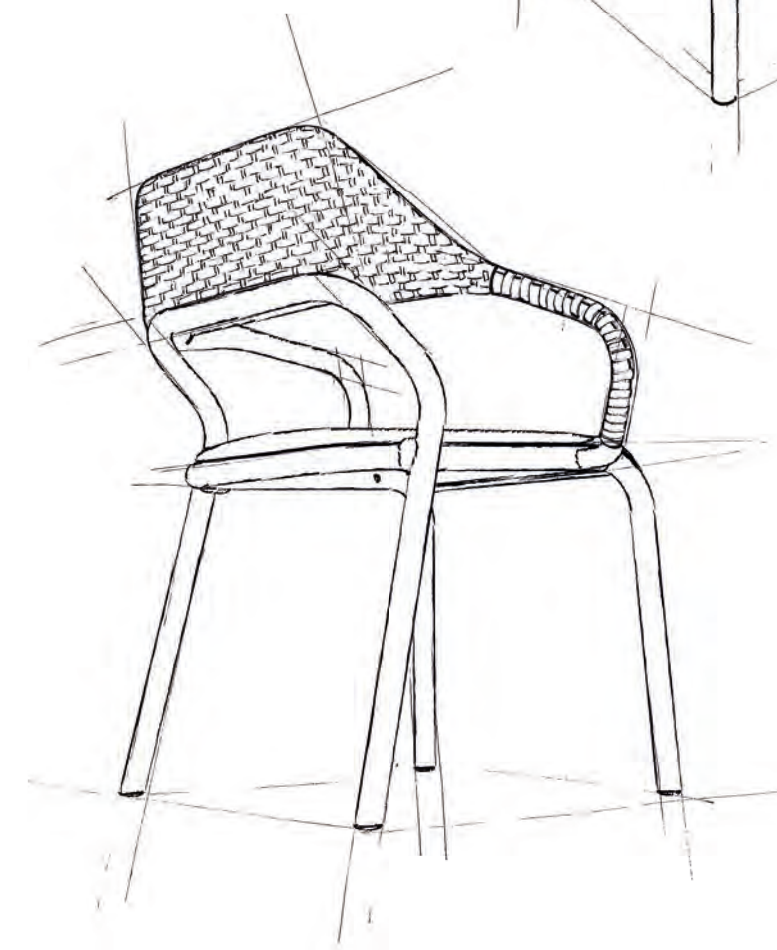

COLLECTION

SMART

DESIGN R&D VARASCHIN

Collezione di sedute con struttura in alluminio verniciato a polveri, seduta in tessuto tecnico VAR#TEX, schienali intrecciati in cordino sintetico VAR#TEX.

MATERIALE REGISTRATO

Collection of seats with powder-coated aluminum structure, seat in VAR#TEX technical fabric, woven backs in VAR#TEX synthetic rope.

REGISTERED MATERIAL

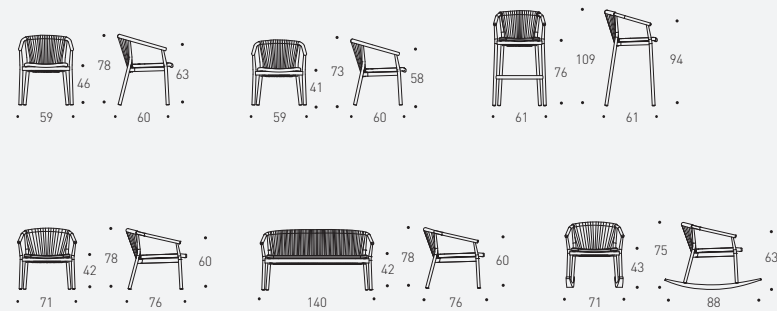



DONDOLI LOUNGE E DIVANO SMART - TAVOLINI SYSTEM / SMART LOUNGE ROCKINGS AND SOFA - SYSTEM COFFEE TABLES

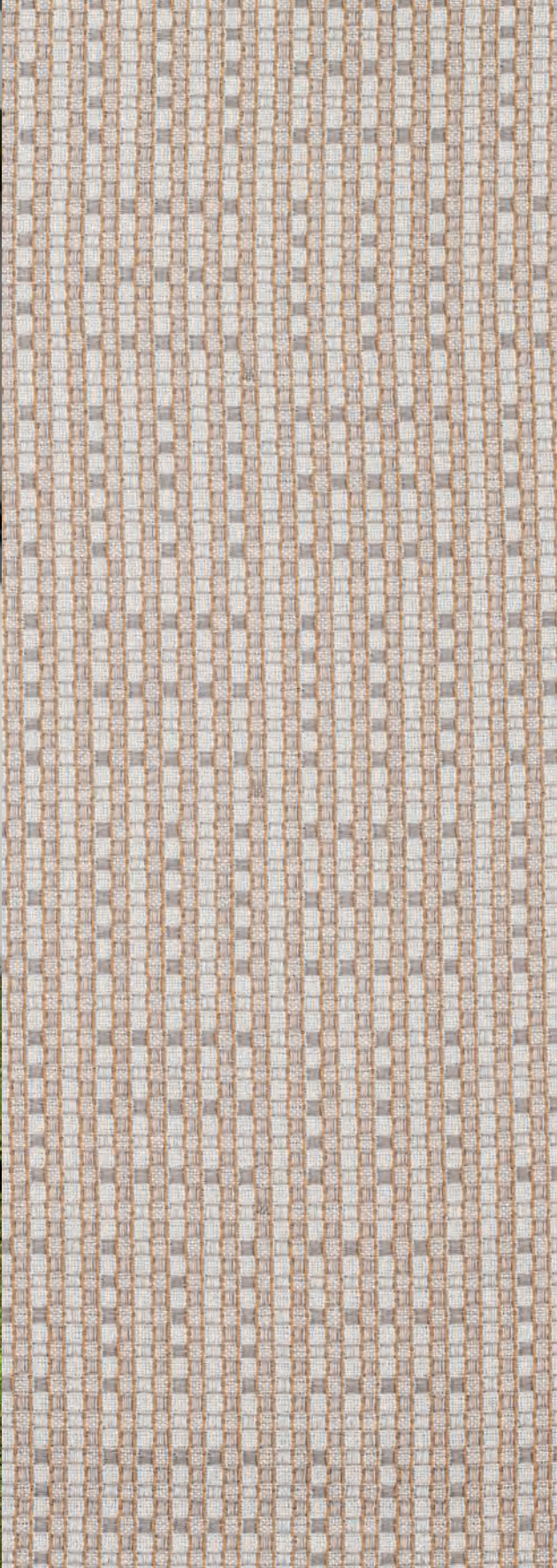

DONDOLI LOUNGE E DIVANO SMART - TAVOLINI SYSTEM / SMART LOUNGE ROCKINGS AND SOFA - SYSTEM COFFEE TABLES



POLTRONCINE SMART - TAVOLI PLINTO / SMART ARMCHAIRS - PLINTO TABLES



POLTRONCINE SMART - TAVOLI PLINTO / SMART ARMCHAIRS - PLINTO TABLES



POLTRONCINE LOW SMART - TAVOLO LOW ELLISSE / SMART LOW ARMCHAIRS - ELLISSE LOW TABLES





POLTRONE LOUNGE SMART - TAVOLO LOW ELLISSE / SMART LOUNGE ARMCHAIRS - ELLISSE LOW TABLES



POLTRONE LOUNGE SMART - TAVOLINO SYSTEM / SMART LOUNGE ARMCHAIRS - SYSTEM COFFEE TABLES







POLTRONCINE SMART - TAVOLI PLINTO / SMART ARMCHAIRS - PLINTO TABLES



SGABELLI SMART - TAVOLI PLINTO / SMART STOOLS - PLINTO TABLES

SMART
STYLE MOOD

CORDINO VAR#TEX CENERE
ROPE VAR#TEX CENERE

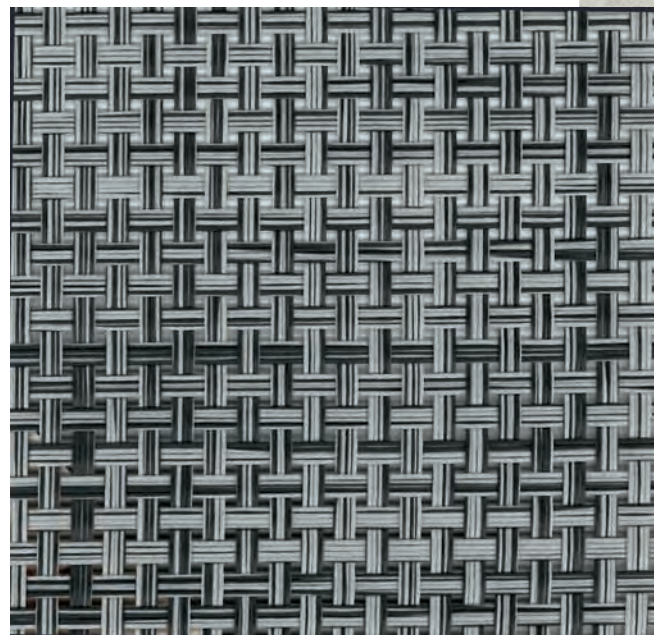

VAR#TEX CENERE

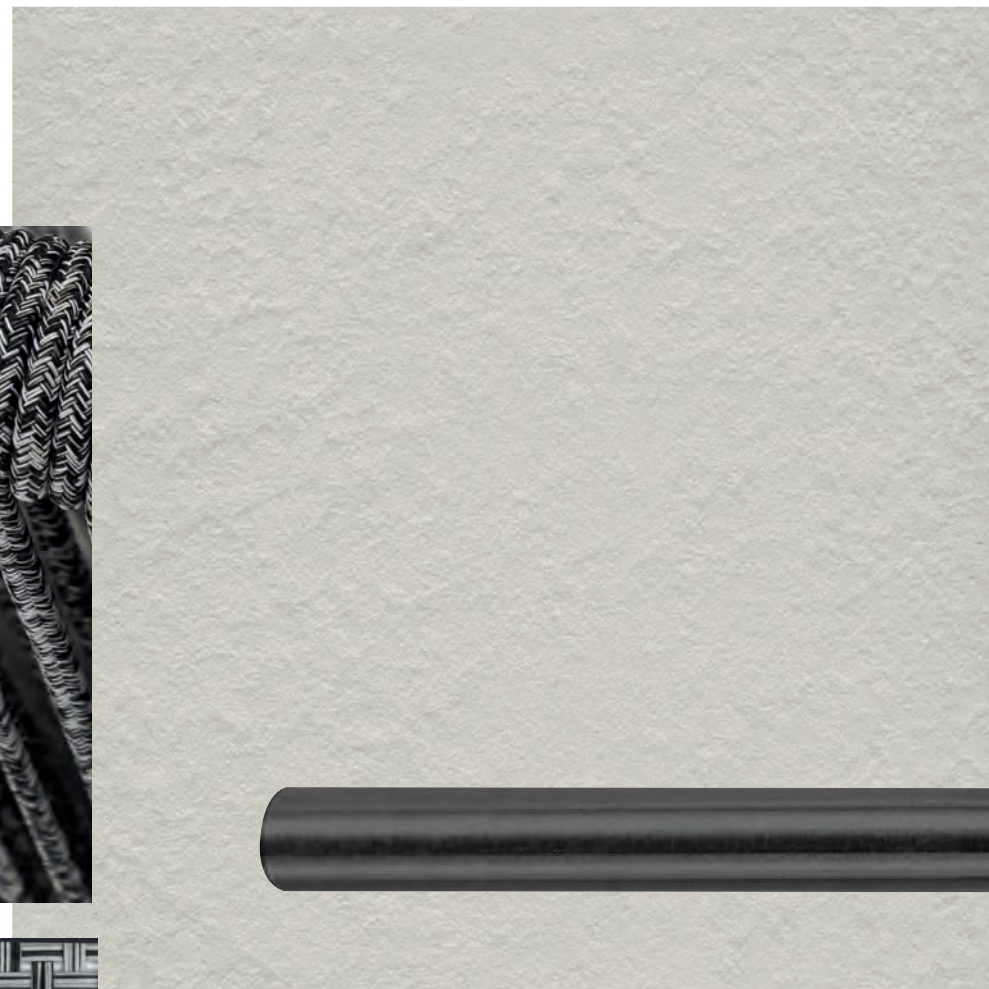

HPL GRIGIO SETA



ALLUMINIO GRIGIO
GREY ALUMINIUM



ABACO SETA



PIPER MARMO



ABACO ANTRACITE

/STRUTTURA BIANCO
WHITE STRUCTURE



POLTRONCINA
ARMCHAIR
VAR#TEX BIANCO



POLTRONCINA LOW
LOW ARMCHAIR
VAR#TEX BIANCO



SGABELLO
STOOL
VAR#TEX BIANCO



DONDOLO POLTRONA LOUNGE
ROCKING LOUNGE ARMCHAIR
VAR#TEX BIANCO



POLTRONA LOUNGE
LOUNGE ARMCHAIR
VAR#TEX BIANCO



DIVANO 2 POSTI
2 SEATING SOFA
VAR#TEX BIANCO

/STRUTTURA GRIGIO
GREY STRUCTURE



POLTRONCINA
ARMCHAIR
VAR#TEX CENERE



POLTRONCINA LOW
LOW ARMCHAIR
VAR#TEX CENERE



SGABELLO
STOOL
VAR#TEX CENERE



DONDOLO POLTRONA LOUNGE
ROCKING LOUNGE ARMCHAIR
VAR#TEX CENERE



POLTRONA LOUNGE
LOUNGE ARMCHAIR
VAR#TEX CENERE



DIVANO 2 POSTI
2 SEATING SOFA
VAR#TEX CENERE

COLLECTION

TIBIDABO

DESIGN CALVI BRAMBILLA

Collezione intrecciata a mano in fibra sintetica con struttura in alluminio verniciato a polveri. Cuscini con imbottitura gomme Dryfeel® da esterno.

MODELLO REGISTRATO

Collection in powder coated aluminium frame and hand woven man-made fibre. Cushions in Dryfeel® outdoor foam.

REGISTERED MODEL

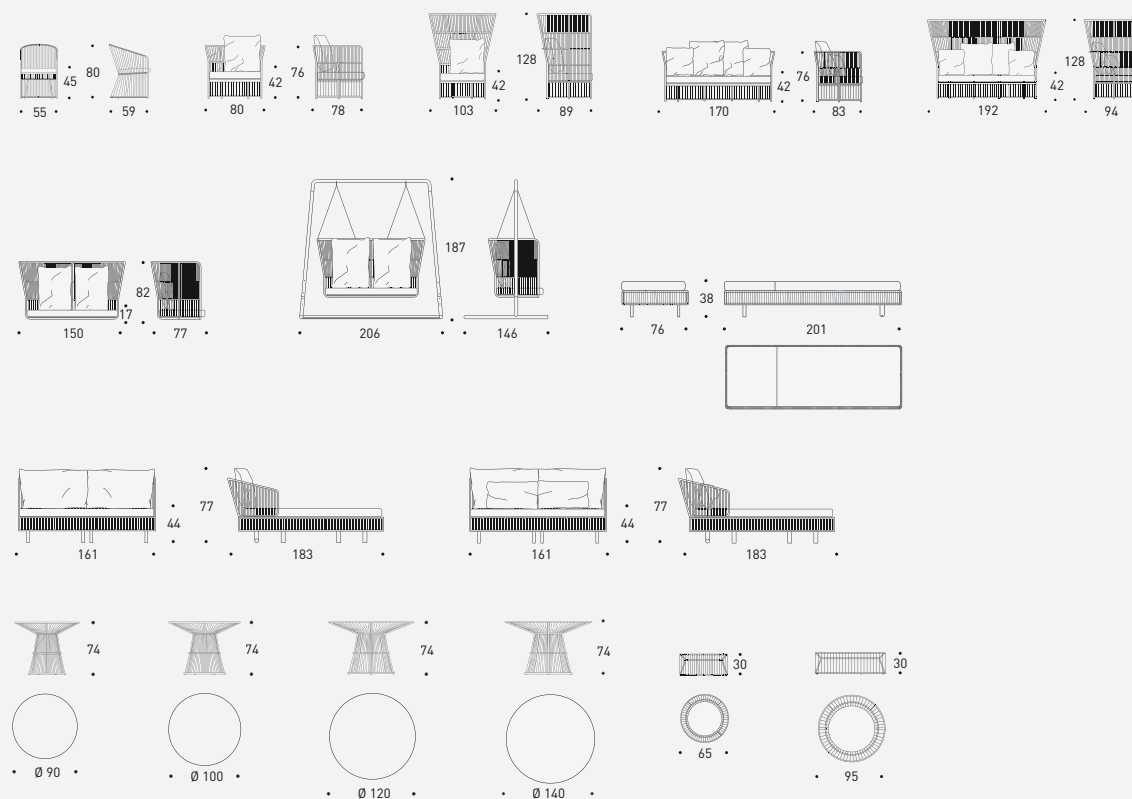

Altezza riferita con top Hpl e ceramica / Height reported with Hpl top and ceramic



















CORDINO PERLA
PERLA ROPE

ALLUMINIO GRIGIO SETA
SILK GREY ALUMINIUM

LOPEZ BIANCO

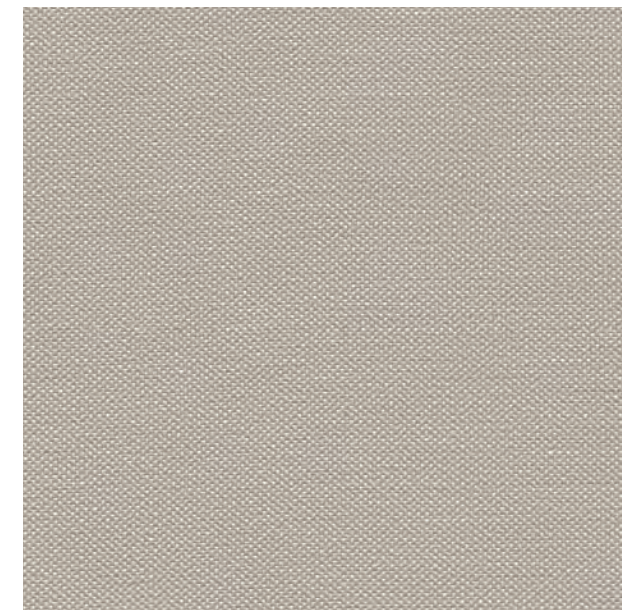
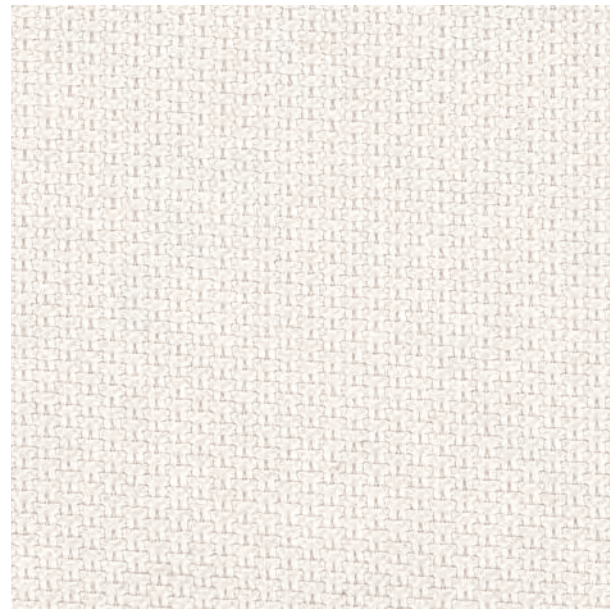

ABACO SETA

TIBIDABO STYLE MOOD

MARINE GRIGIO

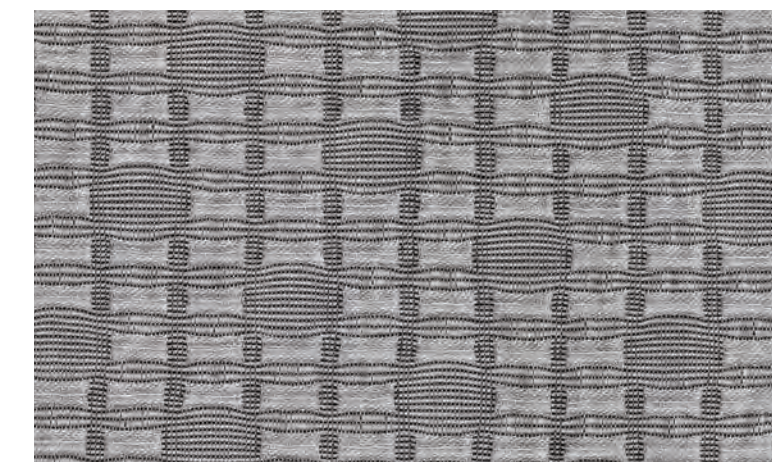
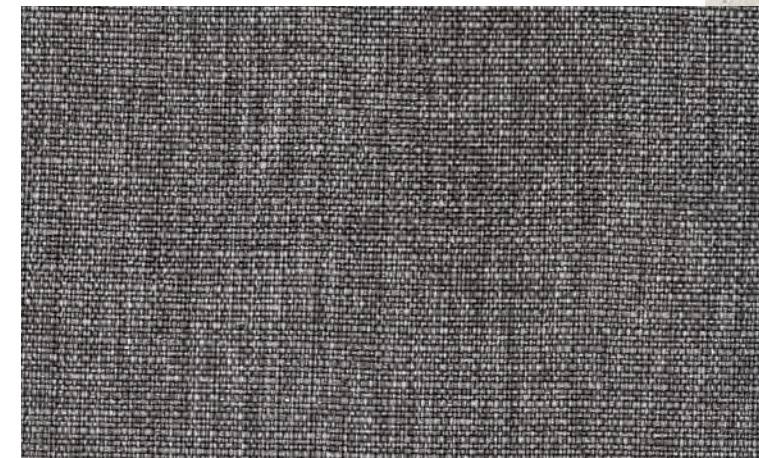

VOGUE PIQUET



CERAMICA BOCCIARDATA BIANCO CALCE
BUSH-HAMMERED CERAMIC LIME WHITE



CALVI BRAMBILLA TALK ABOUT TIBIDABO

L'ispirazione nasce da un libro per bambini di Bruno Munari "Disegnare un albero", dove partendo da una schematizzazione grafica della crescita vegetale, Munari insegna a disegnare vari tipi di alberi: una semplice linea che rappresenta il tronco si moltiplica in maniera regolare e proporzionale fino a formare la chioma. Abbiamo pensato di portare questo schema di crescita su un foglio bianco e poi di curvare il foglio stesso attorno ai cuscini. Il risultato è un binomio di eleganza essenziale ed estrema semplicità associato a colorazioni bianco e nero che ne sottolineano l'estetica fortemente grafica.

The inspiration comes from a children's book by Bruno Munari, "Draw a tree". In the book Munari teaches how to draw various types of trees starting from a plant growth graphic schematization. A simple line represents the trunk and multiplies on a regular and proportional basis until it forms the foliage. We had the intuition to bring this growth pattern onto a white sheet and then bend the sheet around the pillows. The result is a combination of essential elegance and extreme simplicity associated with black and white colorings which emphasize the strong graphic aesthetics.

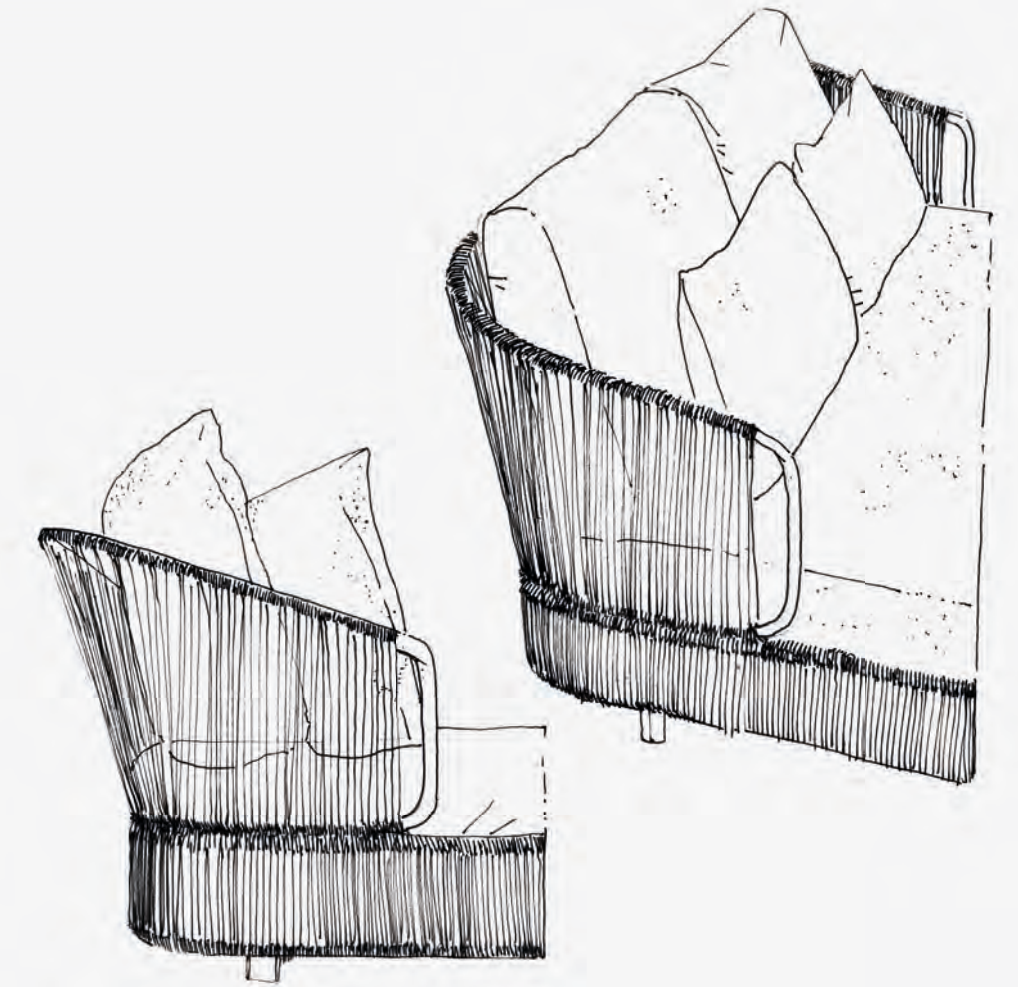

COLLECTION

VICTOR BRONZO

DESIGN R&D VARASCHIN

Collezione con struttura in alluminio verniciato a polveri, finitura bronzo o teak, sedute e schienali in tessuto traforato batyline in differenti cromie, texture gabardina o tessuti resistenti alla tensione.

Collection with powder coated aluminium frame, bronze finish or teak, seat and backrest in batyline in different colours, gabrdina texture or fabrics resilient to tension.

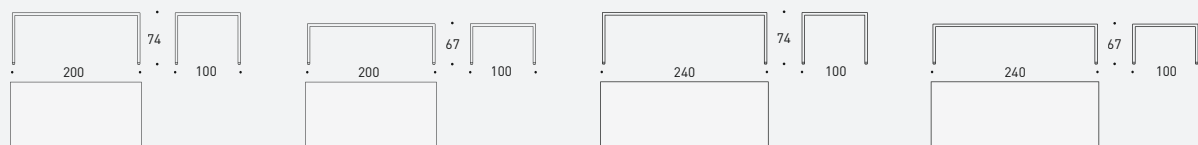
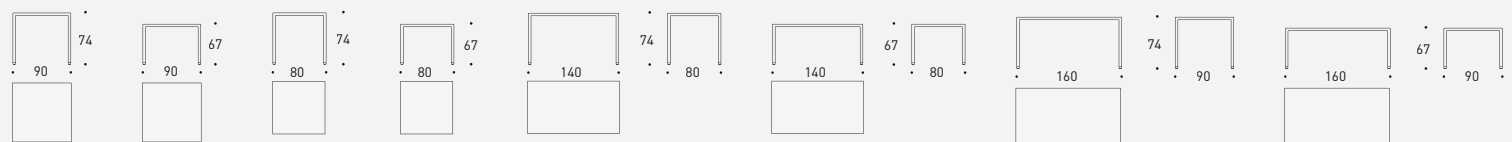
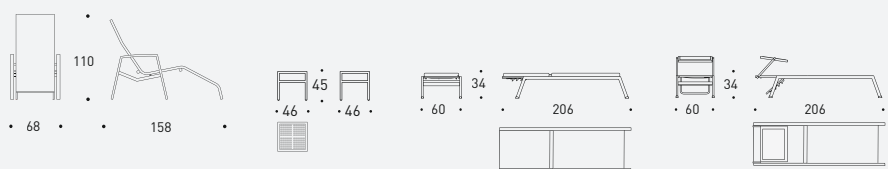
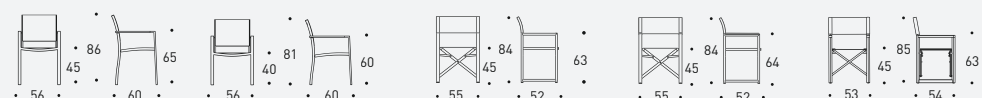

Altezza riferita con top Hpl e ceramica / Height reported with Hpl top and ceramic











POLTRONE LOUNGE SUMMER SET - TAVOLO LOW VICTOR / SUMMER SET LOUNGE ARMCHAIRS - VICTOR LOW TABLE



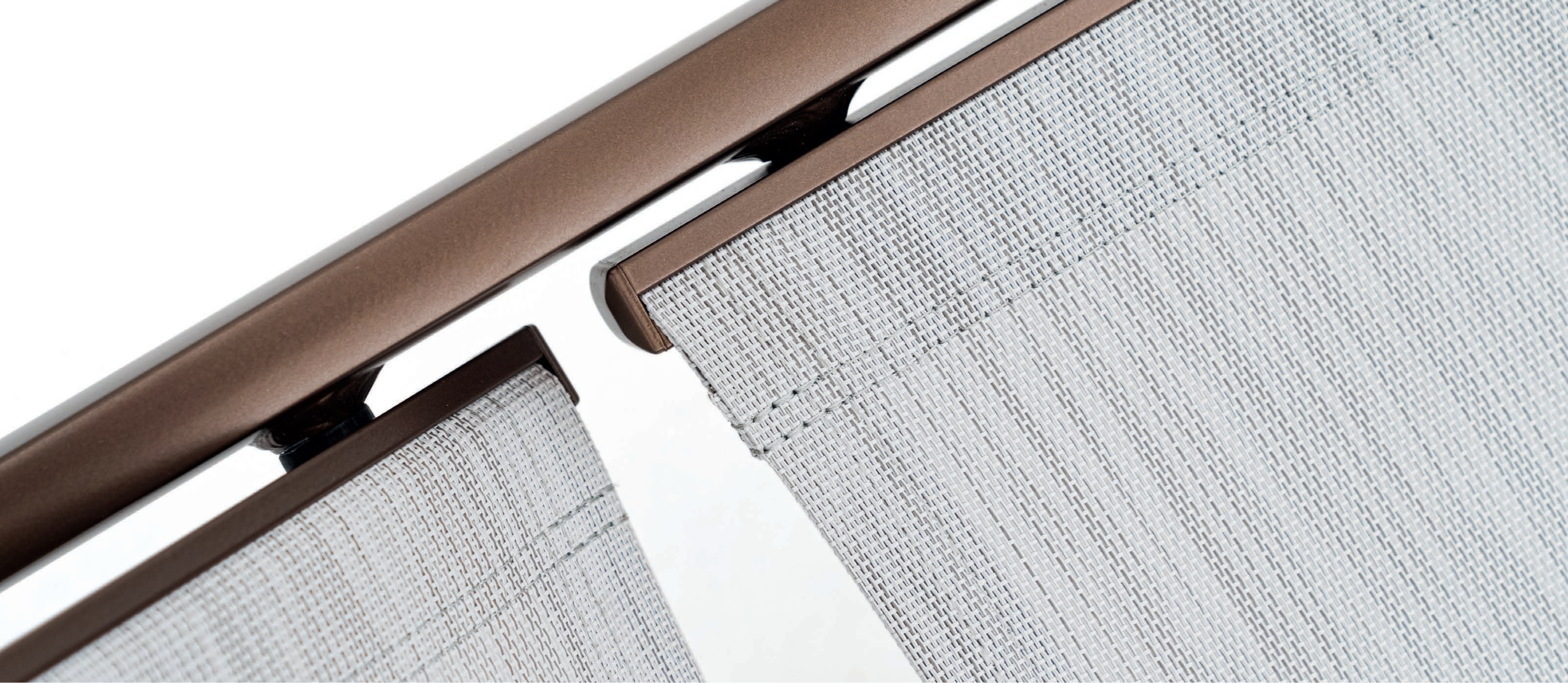

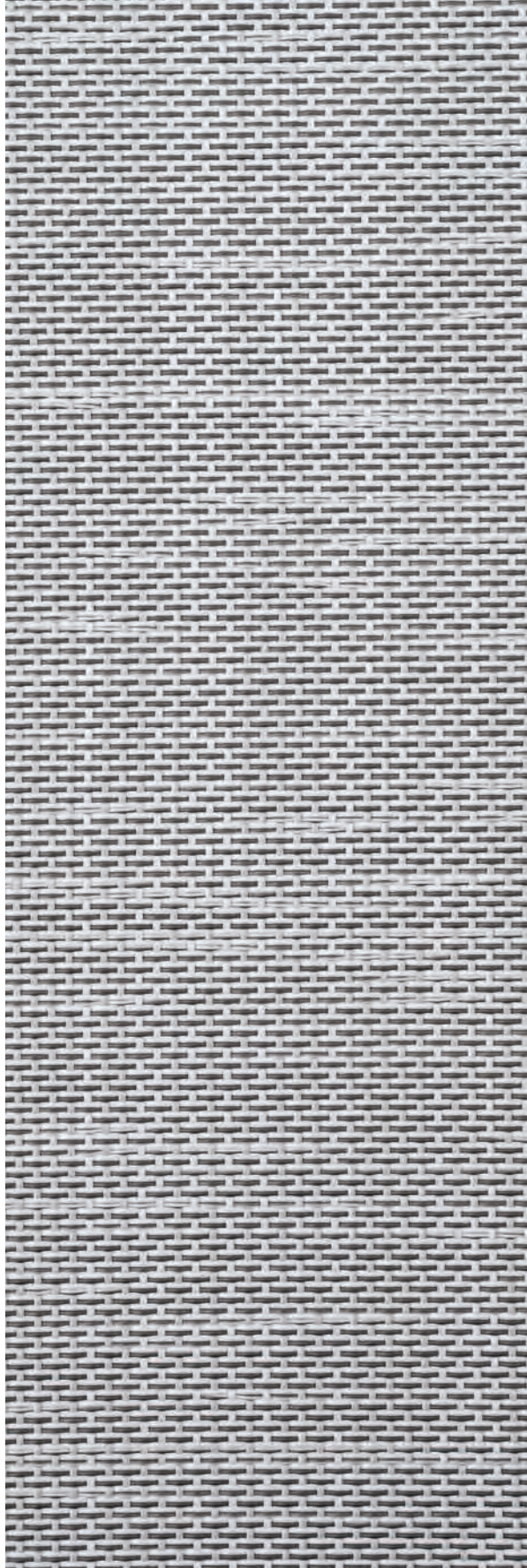





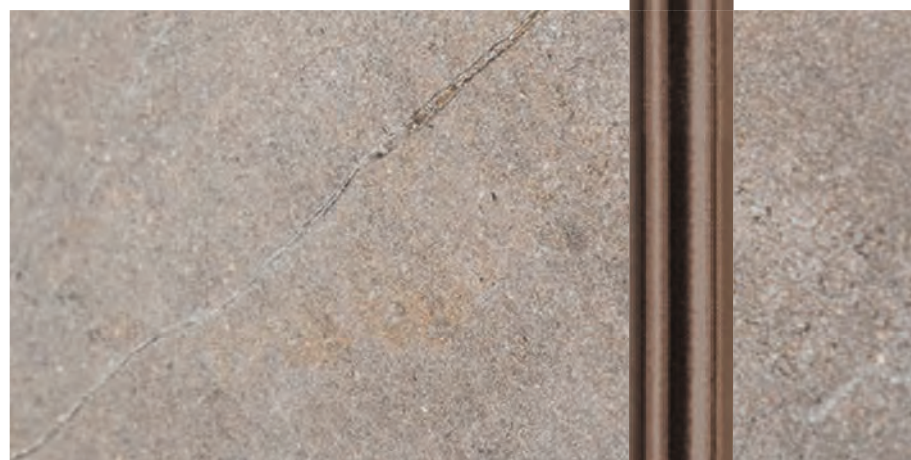

VICTOR
STYLE MOOD

CERAMICA BOCCIARDATA PORFIDO GRIGIO
BUSH-HAMMERED CERAMIC GREY PORPHYRY

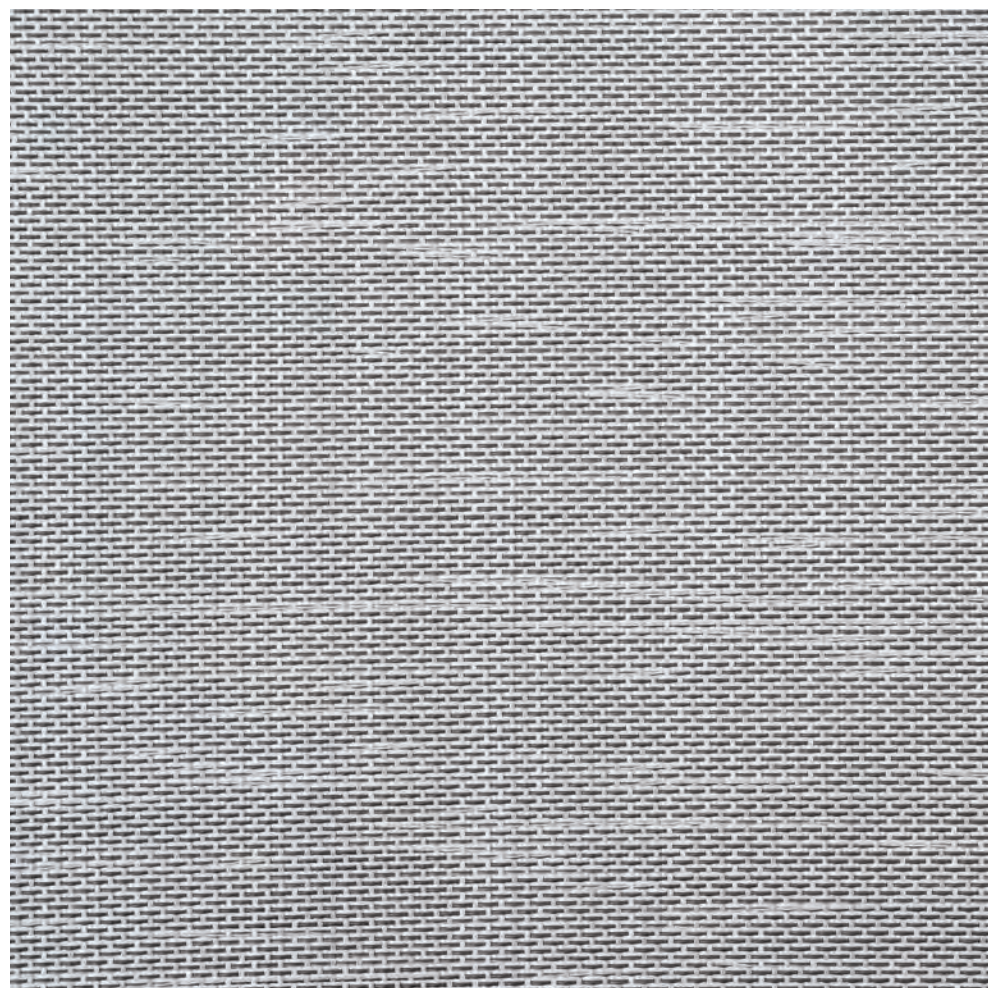

TEXTURE GABARDINA

ALLUMINIO BRONZO
BRONZE ALUMINIUM

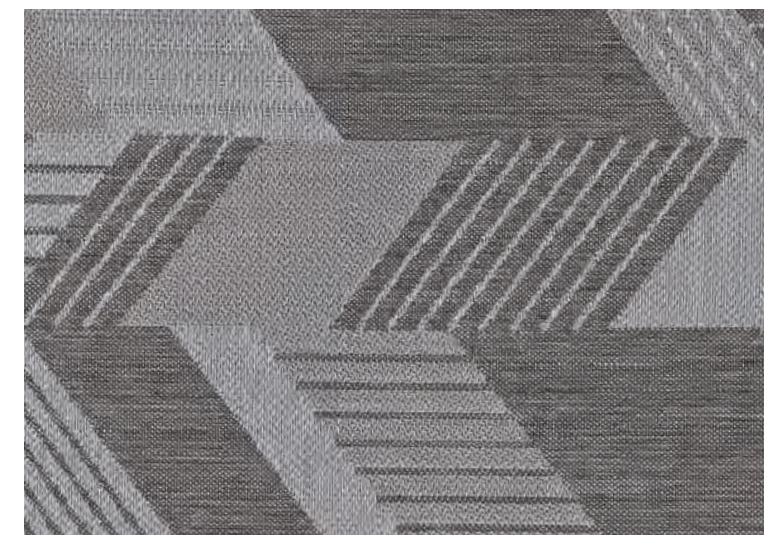

VEGETAL GREY

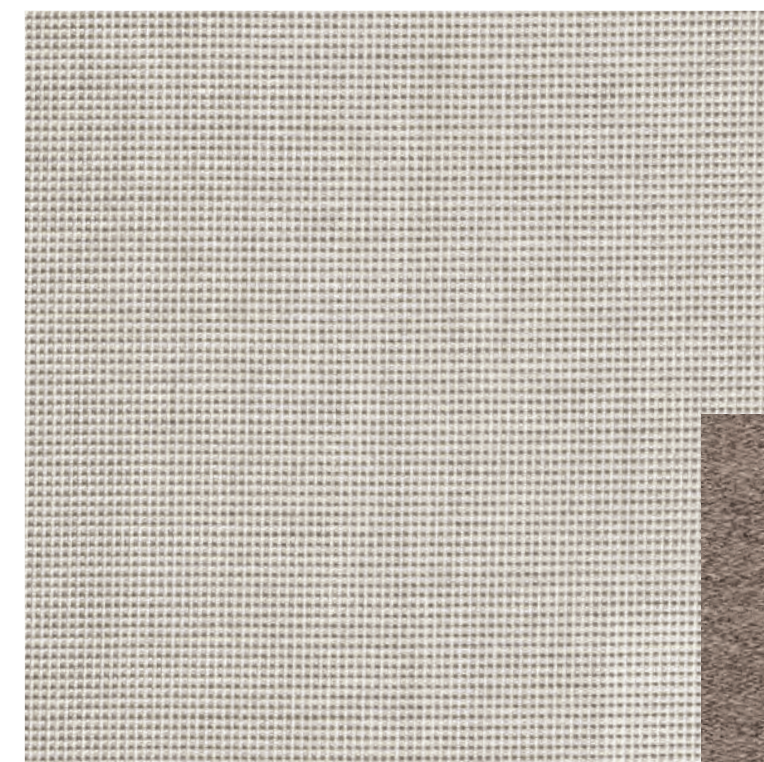

PIPER MARMO



PASHMINA ALPACA

COLLECTION

PLINTO

DESIGN PIO E TITO TOSO

Base tavolo a colonna centrale realizzata in estruso di alluminio, basamento a terra in pressofusione di alluminio il tutto verniciato a polvere. Versione zavorrata mediante lastra di acciaio zincato applicata sotto il basamento.

MODELLO REGISTRATO

Central column table base made of extruded aluminum, ground base in die-cast aluminum, all powder coated.

Weighted down using a galvanized steel plate applied under the base.

REGISTERED MODEL

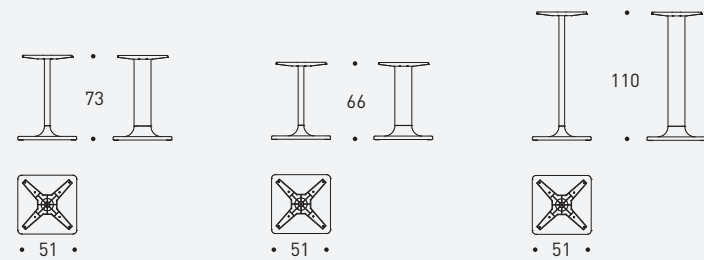

Altezza riferita senza top / Height reported without top





POLTRONCINE NOSS - TAVOLI PLINTO / NOSS ARMCHAIRS - PLINTO TABLES



POLTRONCINE NOSS - TAVOLI PLINTO / NOSS ARMCHAIRS - PLINTO TABLES



POLTRONCINE SMART - TAVOLI PLINTO / SMART ARMCHAIRS - PLINTO TABLES



SGABELLI EMMA - TAVOLO PLINTO / EMMA STOOLS - PLINTO TABLE



PLOTRONCINE EMMA - TAVOLO PLINTO / EMMA ARMCHAIRS - PLINTO TABLE



SGABELLI SMART - TAVOLI PLINTO / SMART STOOLS - PLINTO TABLES

STRIPES ARGENTO



PLINTO
STYLE MOOD

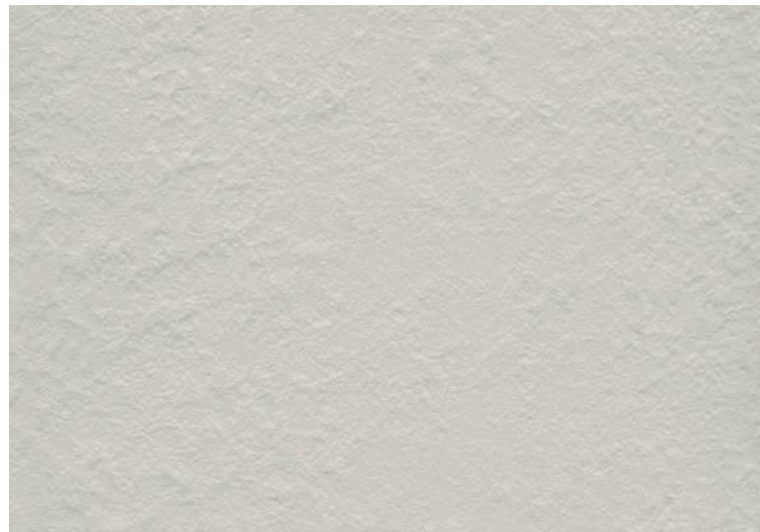

HPL GRIGIO SETA
HPL SILK GREY

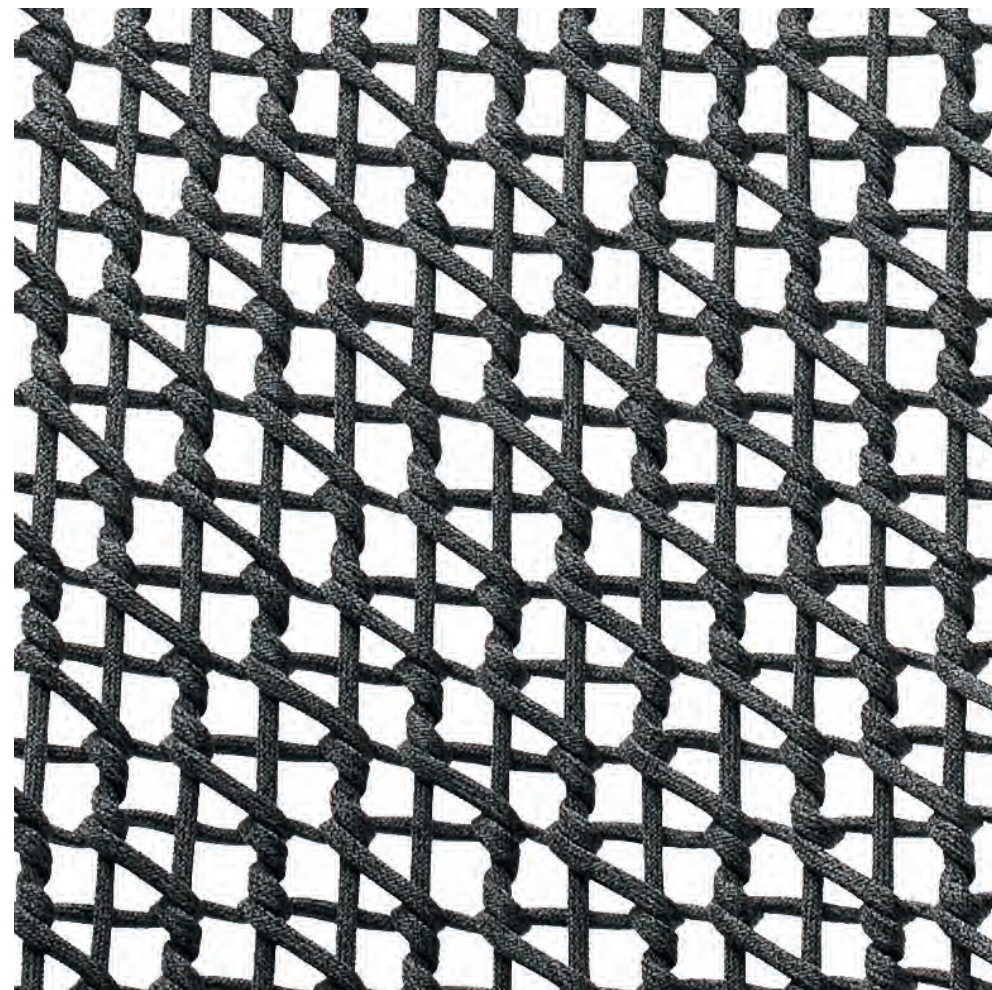

VAR#ROPE DARK GREY

ALLUMINIO GRIGIO
GREY ALUMINIUM

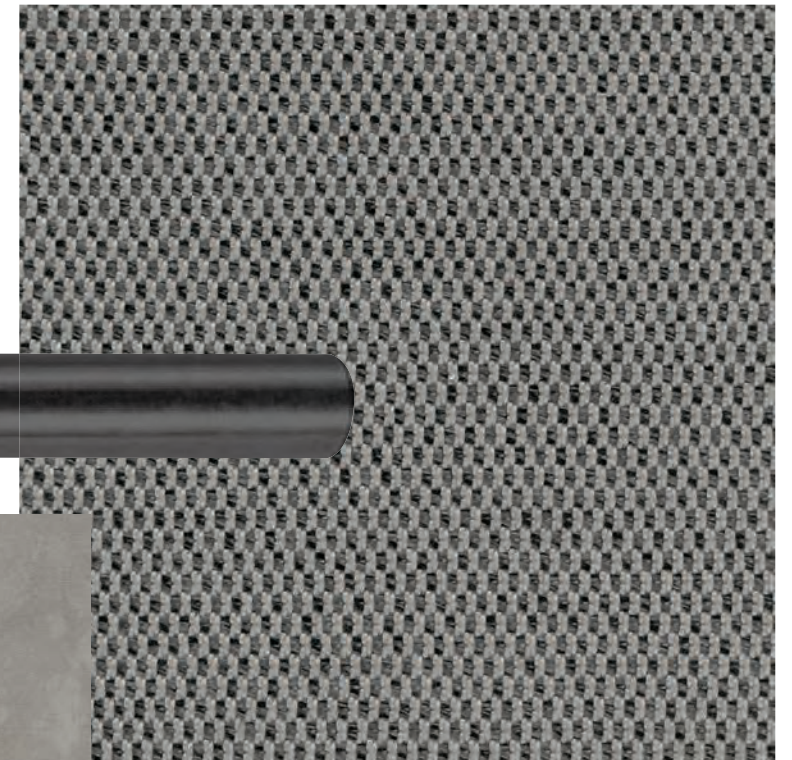
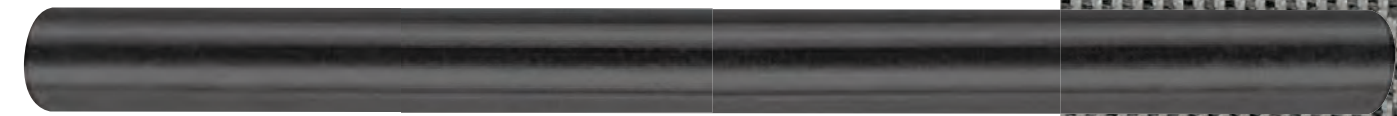

LOPEZ CARBONE



HPL CEMENTO



PIPER SAVANE



PIO E TITO TOSO TALK ABOUT PLINTO

Plinto nasce dalla ricerca di sintesi fra bellezza e funzionalità. Plinto si ispira alla natura, più precisamente ad un tronco di albero e alle sue radici che lo sostengono: paradigma di stabilità. Plinto è una base compatta che ispira sicurezza, linearità e pulizia ed è in grado di dialogare con l'architettura che la circonda. La particolare forma della base è ottenuta mediante una pressofusione di alluminio che si raccorda con continuità allo stelo, anch'esso di alluminio, ma estruso. La sezione ovale dello stelo consente di percepire una forma variabile con l'angolo di osservazione del tavolo.

*Plinto stems from the search for synthesis between beauty and functionality.
Plinto is inspired by nature, more precisely by a tree and its supporting roots: a stability paradigm.
Plinto is a compact base that inspires safety, linearity and cleanliness and is able to converse with the architecture that surrounds it.
The particular shape of the base is obtained by means of an aluminum die-casting, continuously connected to the stem which is also made of aluminum, but extruded.
The oval section of the stem allows you to perceive a variable shape according to the viewing angle.*

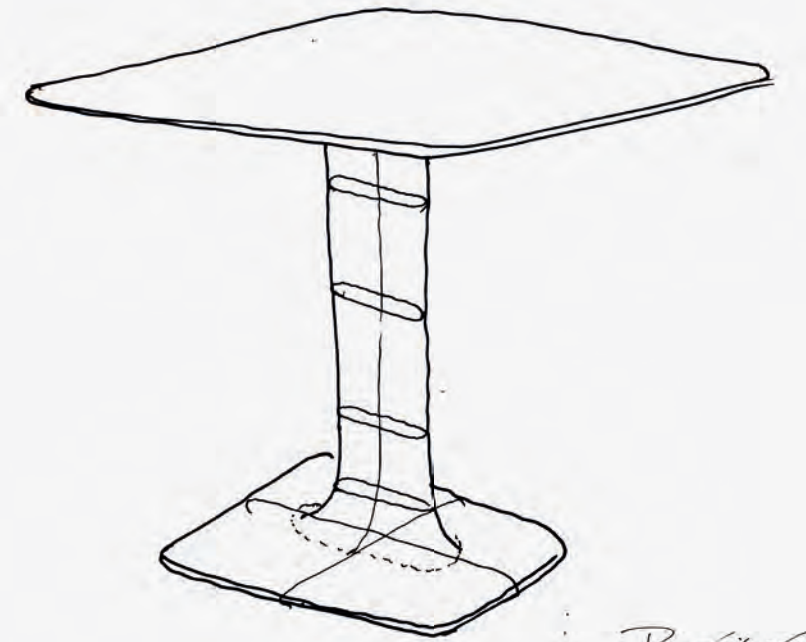
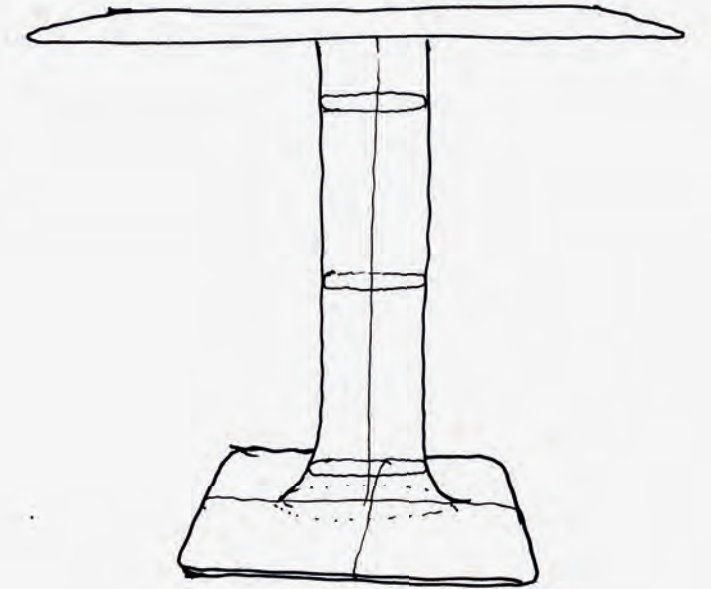

COLLECTION

BALI BERGÈRE

DECK RELAX

DESIGN DANIELE LO SCALZO MOSCHERI

Collezione con struttura portante a vista in legno massello di teak di piantagione certificata. Sedute e schienali imbottiti con gomme Dryfeel da esterno.

MODELLO REGISTRATO

Collection in plantation certified solid teak. Padded seat and backs with Dryfeel outdoor foam.

REGISTERED MODEL

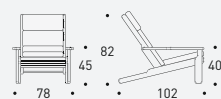



BERGÈRE DECK RELAX BALI - TAVOLINO LAPIS / BALI BERGÈRE DECK RELAX - LAPIS COFFEE TABLE







POLTRONE LOUNGE LAPIS - TAVOLO LOW ELLISSE - BERGÈRE DECK RELAX BALI - TAVOLINO LAPIS /
LAPIS LOUNGE ARMACHARIS - ELLISSE LOW TABLE - BALI BERGÈRE DECK RELAX - LAPIS COFFEE TABLE



TEAK

BALI BERGÈRE DECK RELAX STYLE MOOD

VEGETAL OLIVA

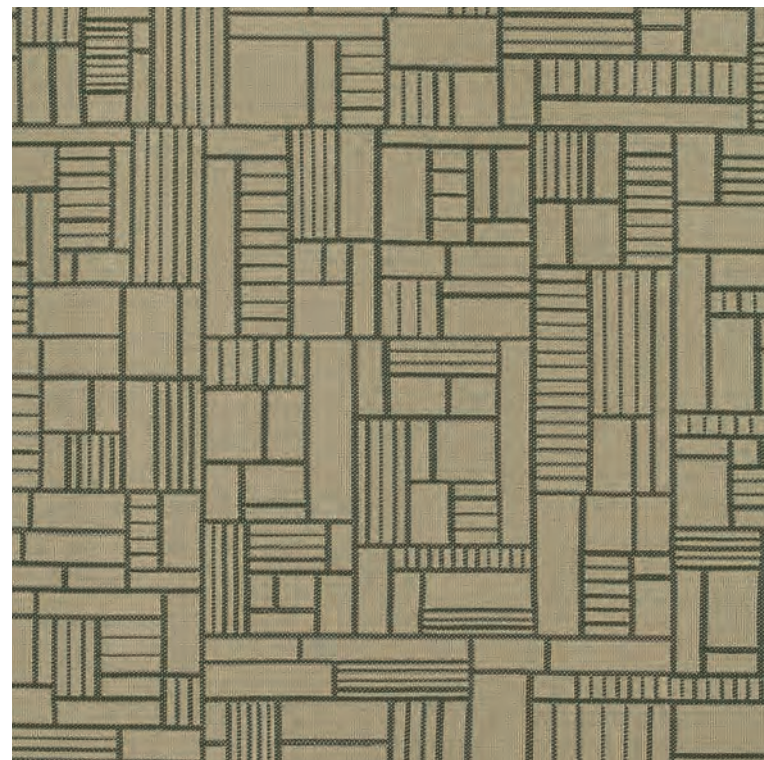

MADRAS VERDE



CANVAS OLIVA

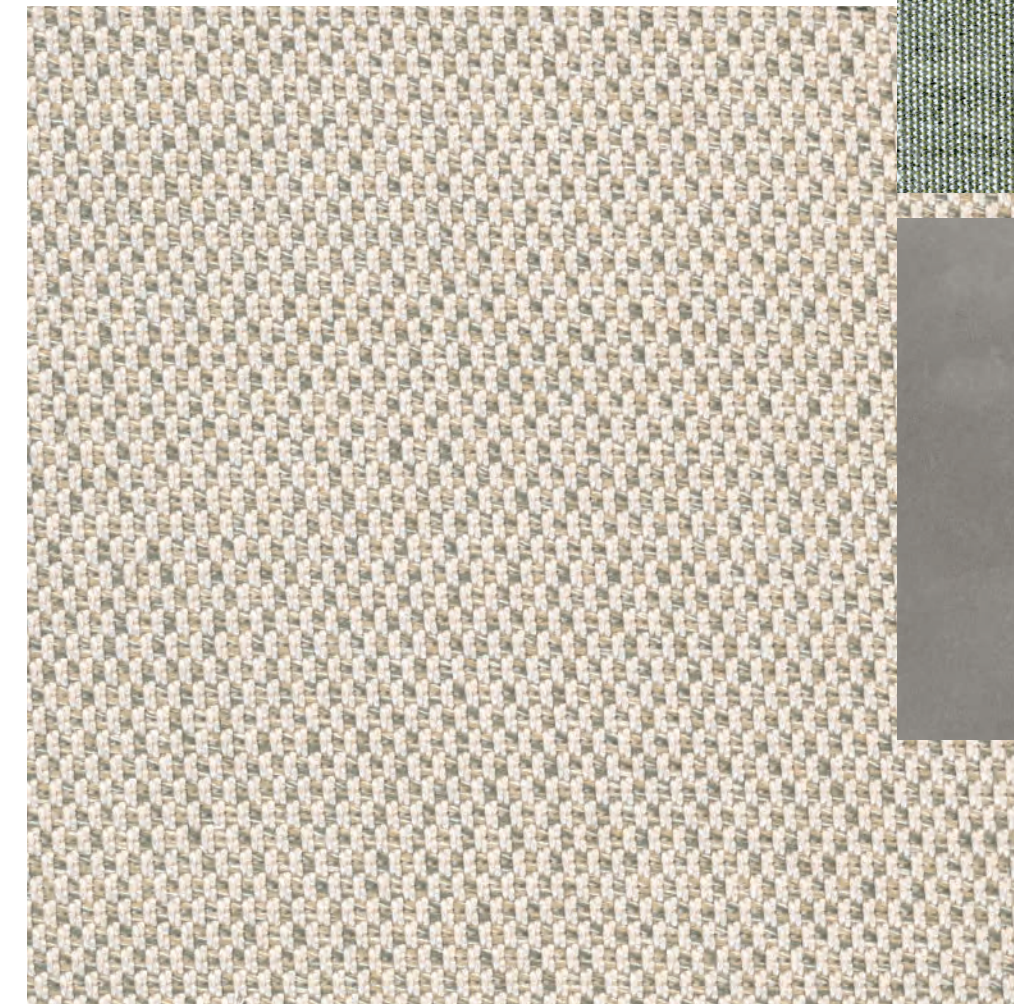
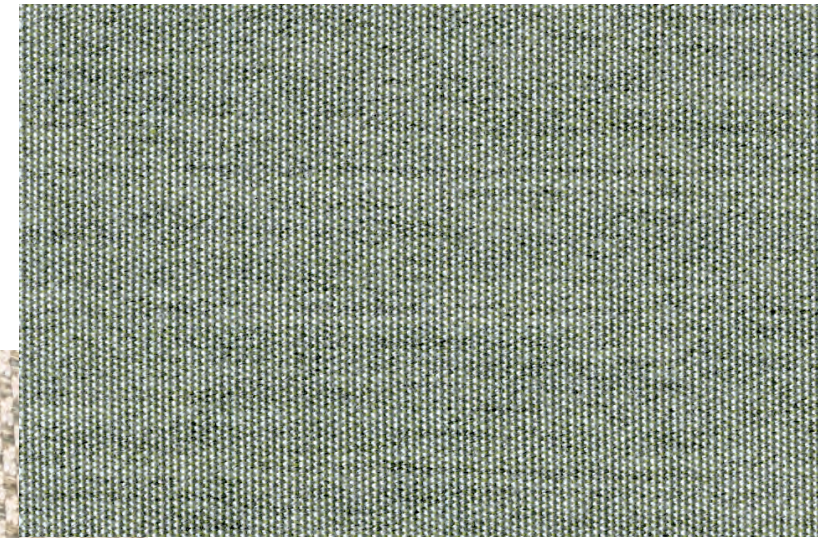

LOPEZ MARMO



HPL CEMENTO

COLLECTION

BAHIA

DESIGN CALVI BRAMBILLA

Collezione con struttura in alluminio verniciato a polveri, sedute e schienali in VAR#TEX (tessuto tecnico in PVC). Modello impilabile.

MODELLO REGISTRATO

Collection in powder coated aluminium frame, seat and backrest in VAR#TEX (PVC based material). Stackable model.

REGISTERED MODEL

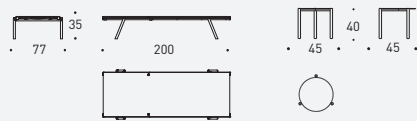

Varaschin Bahia





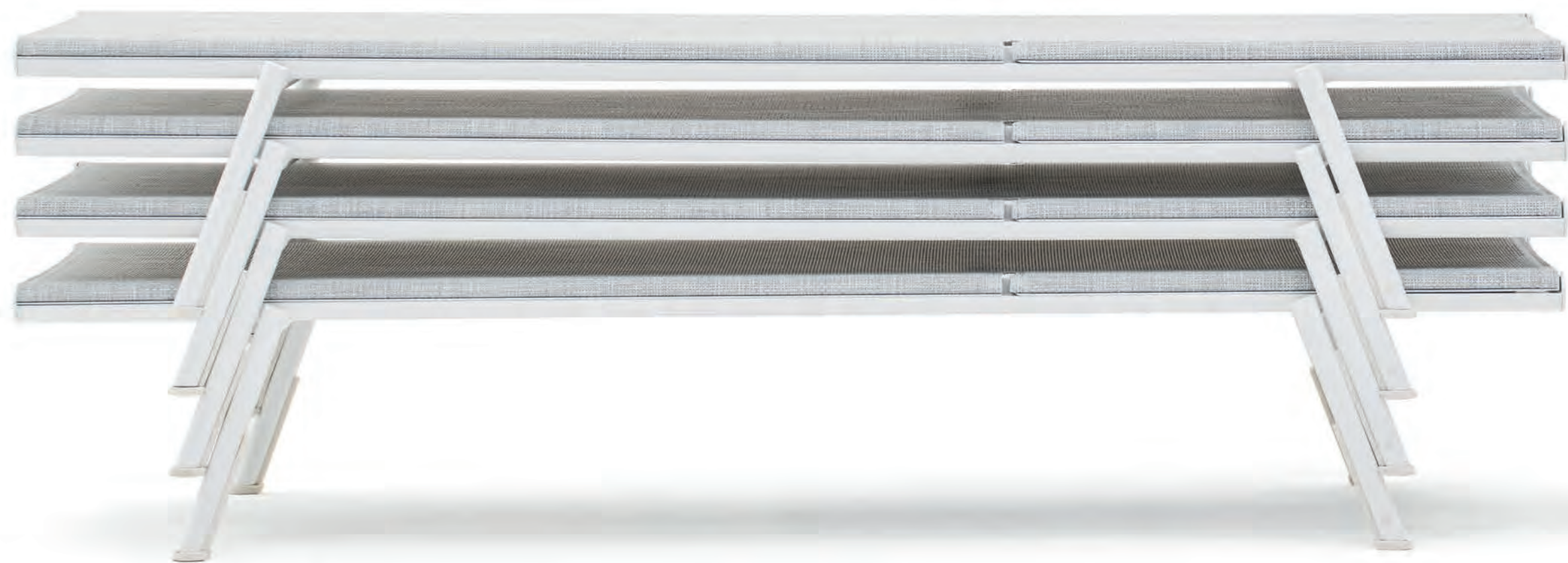

POP BIANCO

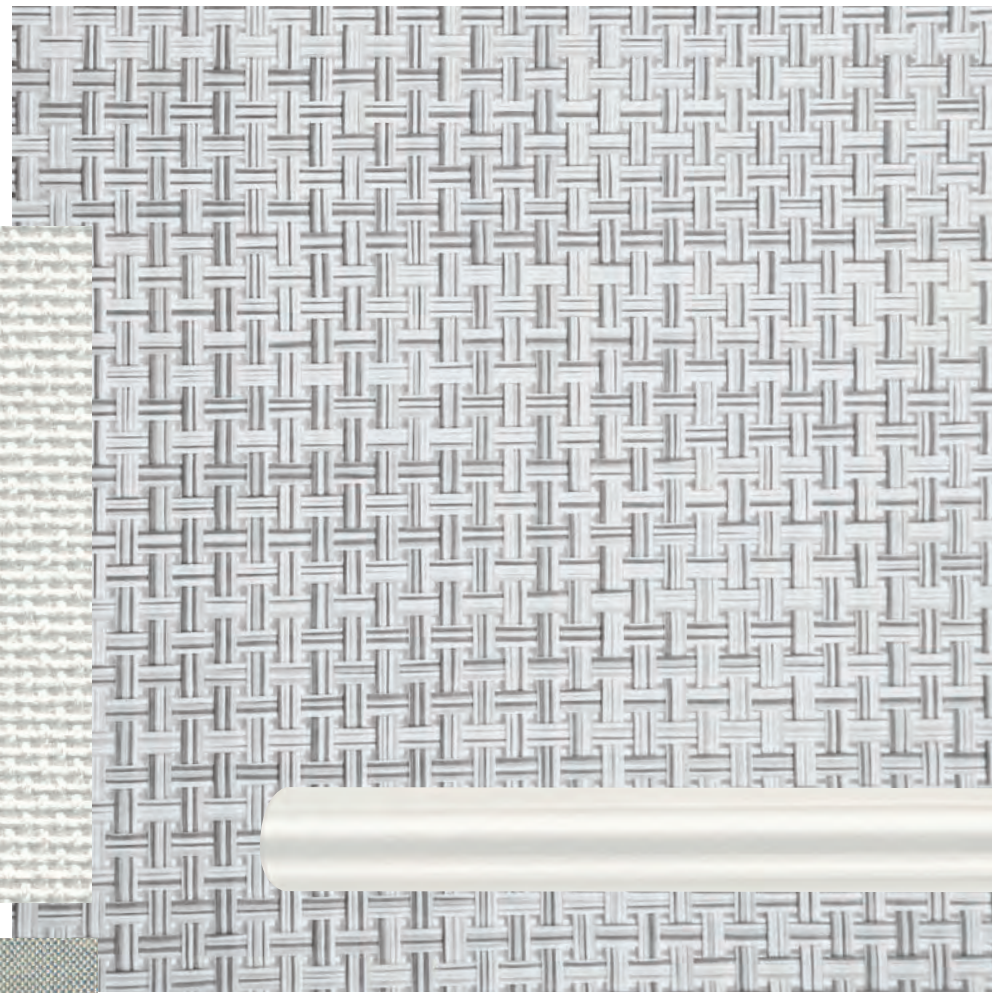

VAR#TEX BIANCO

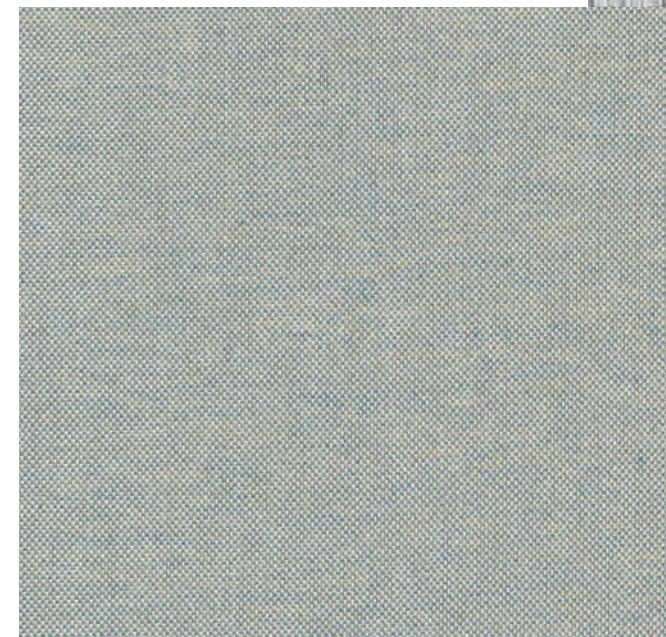

PIPER POLVERE

ALLUMINIO BIANCO
WHITE ALUMINIUM



HPL GRIGIO SETA

BAHIA
STYLE MOOD

STRIPES GHIACCIO

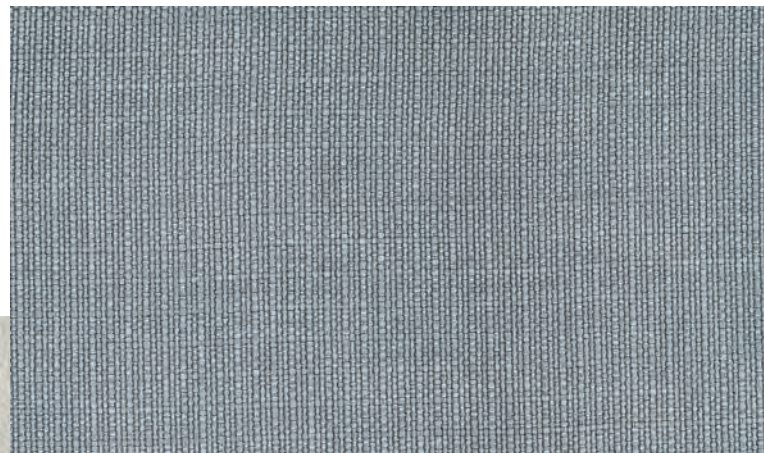
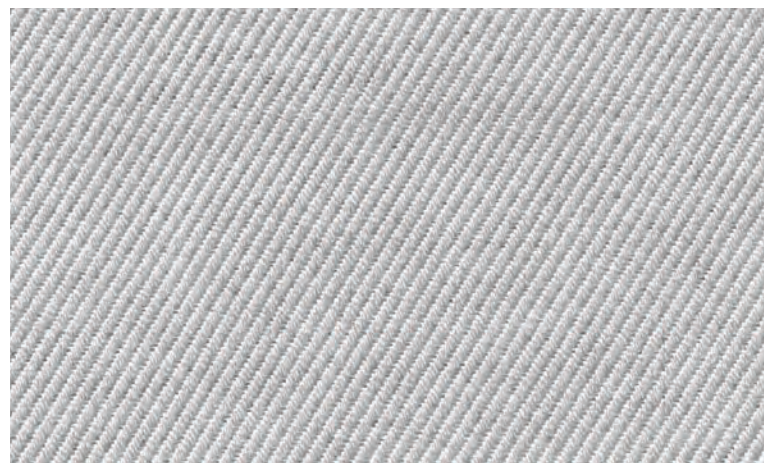

MARINE CARTAZUCCHERO

COLLECTION

CLEVER

DESIGN R&D VARASCHIN

Collezione di sedute composta da poltroncina, poltrone, divano, dondolo, sdraio e sgabello con struttura in alluminio verniciato a polveri, sedute e schienali in VAR#TEX [tessuto tecnico in PVC]. Disponibile anche versione con seduta texture e schienale in cordino sintetico.

MODELLO REGISTRATO

Seating collection composed of chairs, armchairs, sofa, rocking chair, foldable deckchair and stool with powder coated aluminum frame, seat and back in VAR#TEX [PVC based material]. Also available with textylene seat and synthetic rope back.

REGISTERED MODEL

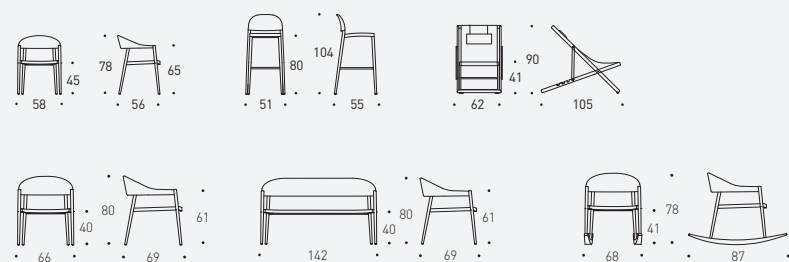



COLLEZIONE CLEVER - TAVOLINI E TAVOLO SYSTEM / CLEVER COLLECTION - SYSTEM COFFEE TABLES AND TABLE



PLOTRONE LOUNGE E DIVANO CLEVER - TAVOLINI SYSTEM / CLEVER LOUNGE ARMCHAIRS AND SOFA - SYSTEM COFFEE TABLES







SDRAIO CLEVER - TAVOLINO BAHIA / CLEVER FOLDABLE DECKCHAIRS - BAHIA COFFEE TABLE





DONDOLI LOUNGE CLEVER - TAVOLINO BAHIA / CLEVER LOUNGE ROCKINGS - BAHIA COFFEE TABLE





POLTRONCINE CLEVER - TAVOLO ELLISSE / CLEVER ARMCHAIRS - ELLISSE TABLE





POLTRONE LOUNGE CLEVER - TAVOLO LOW BIG / CLEVER LOUNGE ARMCHAIRS - BIG LOW TABLE



SGABELLI CLEVER - TAVOLO PLINTO / CLEVER STOOLS - PLINTO TABLE



CERAMICA BOCCIARDATA BIANCO CALCE
BUSH-HAMMERED CERAMIC LIME WHITE



CLEVER STYLE MOOD

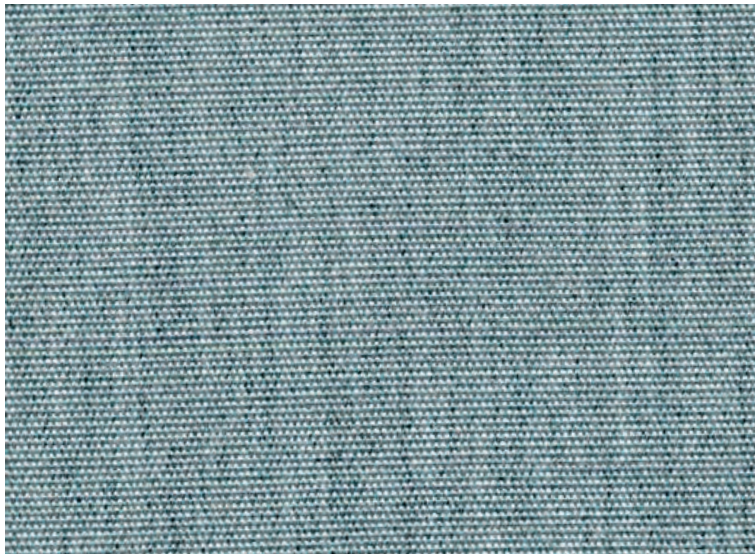

CANVAS ACQUARELLO

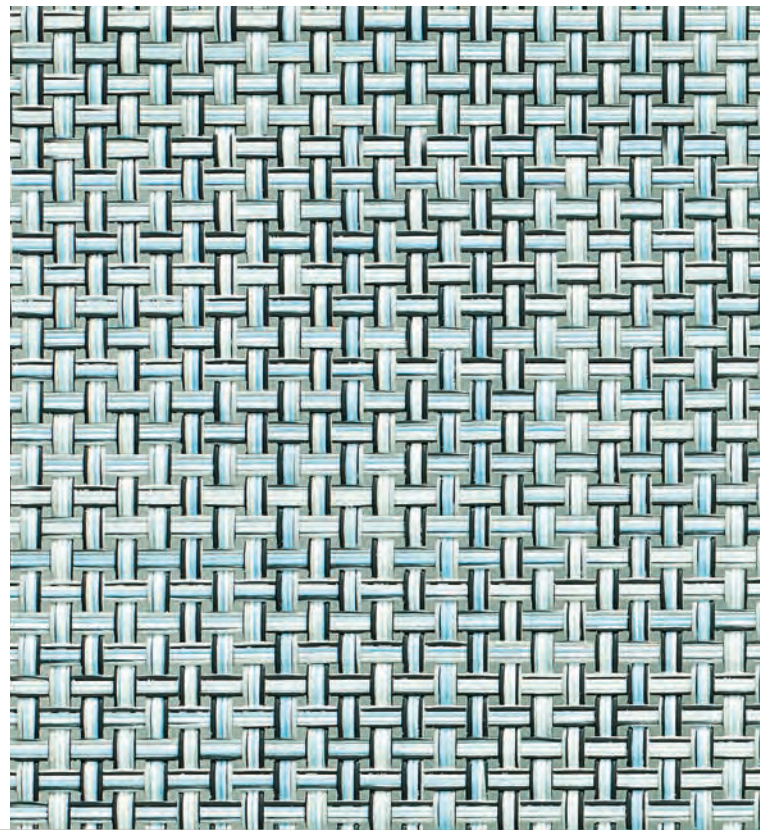

ALLUMINIO GRIGIO SETA
SILK GREY ALUMINIUM

VAR#TEX ACQUERELLO

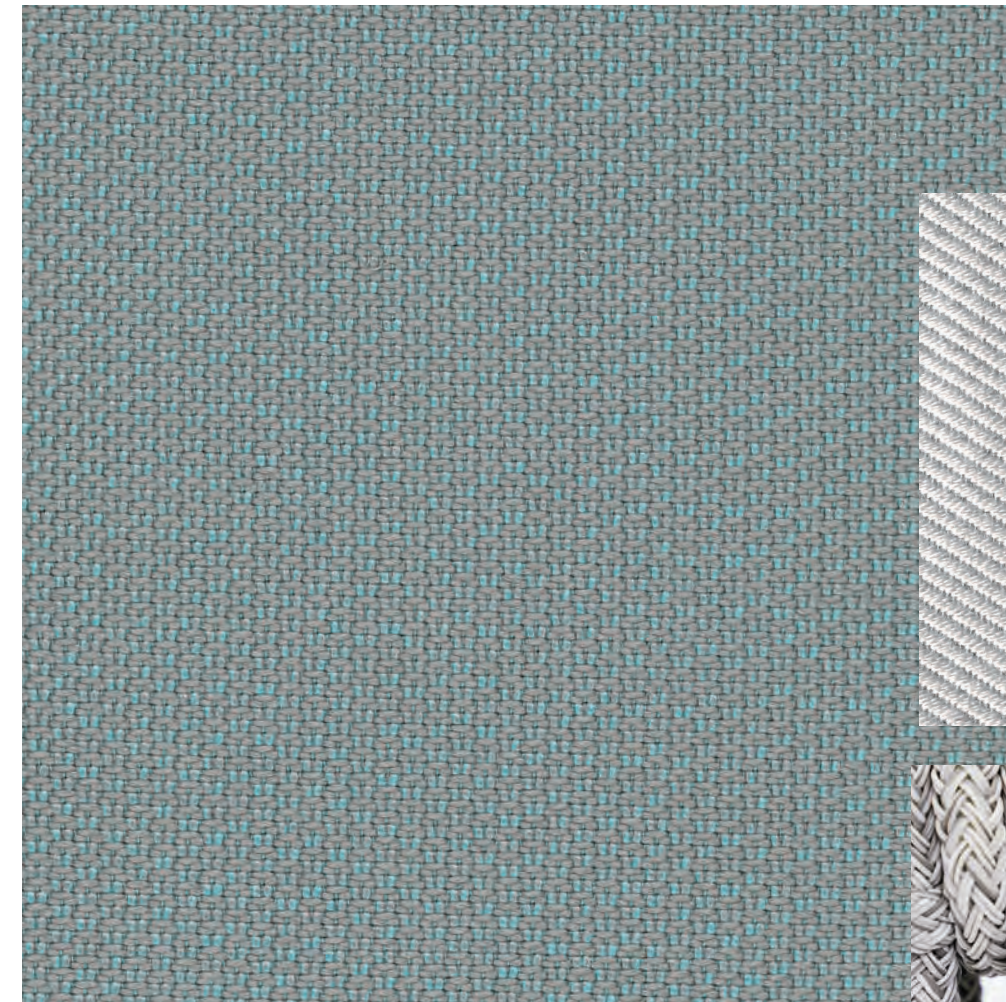

LOPEZ PALUDE

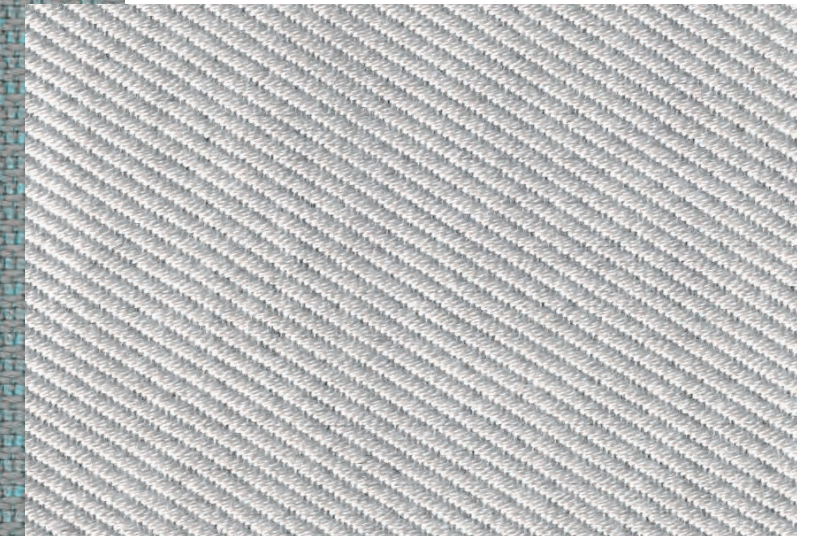

STRIPES GHIACCIO



CORDINO VAR#TEX BIANCO
WHITE VAR#TEX ROPE

/STRUTTURA GRIGIO
GREY STRUCTURE



POLTRONCINA
ARMCHAIR
VAR#TEX CENERE



POLTRONA LOUNGE
LOUNGE ARMCHAIR
VAR#TEX CENERE



DONDOLO POLTRONA LOUNGE
ROCKING LOUNGE ARMCHAIR
VAR#TEX CENERE



DIVANO 2 POSTI
2 SEATER SOFA
VAR#TEX CENERE



SGABELLO
STOOL
VAR#TEX CENERE



SDRAIO PIEGHEVOLE
FOLDABLE DECKCHAIR
VAR#TEX CENERE

/STRUTTURA GRIGIO SETA
SILK GREY STRUCTURE



POLTRONCINA
ARMCHAIR
VAR#TEX ACQUERELLO



POLTRONA LOUNGE
LOUNGE ARMCHAIR
VAR#TEX ACQUERELLO



DONDOLO POLTRONA LOUNGE
ROCKING LOUNGE ARMCHAIR
VAR#TEX ACQUERELLO



DIVANO 2 POSTI
2 SEATER SOFA
VAR#TEX ACQUERELLO



SGABELLO
STOOL
VAR#TEX ACQUERELLO



SDRAIO PIEGHEVOLE
FOLDABLE DECKCHAIR
VAR#TEX ACQUERELLO

/STRUTTURA BIANCO
WHITE STRUCTURE



POLTRONCINA
ARMCHAIR
VAR#TEX BIANCO



POLTRONA LOUNGE
LOUNGE ARMCHAIR
VAR#TEX BIANCO



DONDOLO POLTRONA LOUNGE
ROCKING LOUNGE ARMCHAIR
VAR#TEX BIANCO



DIVANO 2 POSTI
2 SEATER SOFA
VAR#TEX BIANCO



SGABELLO
STOOL
VAR#TEX BIANCO



SDRAIO PIEGHEVOLE
FOLDABLE DECKCHAIR
VAR#TEX BIANCO

BENTO

DESIGN CALVI BRAMBILLA

Collezione componibile imbottita con gomme. Versione outdoor: struttura portante in legno massello di okumé e imbottitura con gomme Dryfeel® da esterno.

Versione indoor: struttura portante in legno massello di abete e imbottitura in gomma normale da interno.

Disponibile con due differenti tipologie di piedini: Botero e Slim.

Bento si caratterizza per la possibilità di creare molteplici combinazioni che facilmente possono essere definite e successivamente anche modificate a discrezione del Cliente. È possibile, infatti, con semplici operazioni modificare più volte la combinazione iniziale ridisponendo a piacimento i moduli già acquistati.

Allo stesso modo il Cliente può aggiungere moduli supplementari acquistabili in un secondo momento, rispettando semplicemente le regole di composizione.

MODELLO REGISTRATO

Modular foam padded collection. Outdoor version: made of okumé solid wood and padded with Dryfeel® outdoor foam.

Indoor version: made of fir wood and padded with standard indoor foam.

Available with two different kind of feet: Botero and Slim.

Bento allows you to create multiple combinations that can be defined even at a later stage and modified by the customer. It is, in fact, possible to change the composition on different occasions at your leisure. With the same thought in mind, the customer can add modules in a second moment, clearly respecting the rules of the modular system.

REGISTERED MODEL

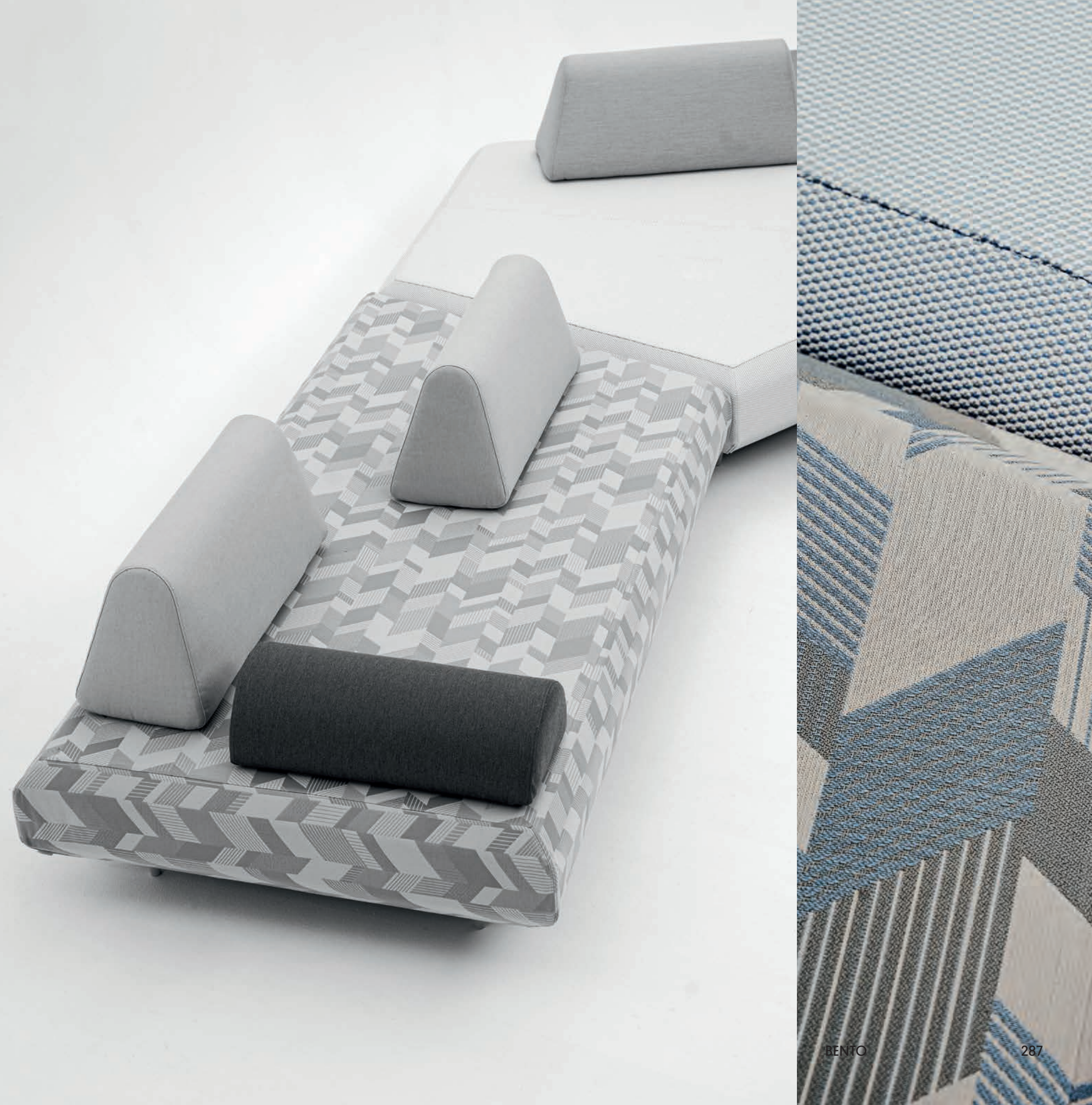
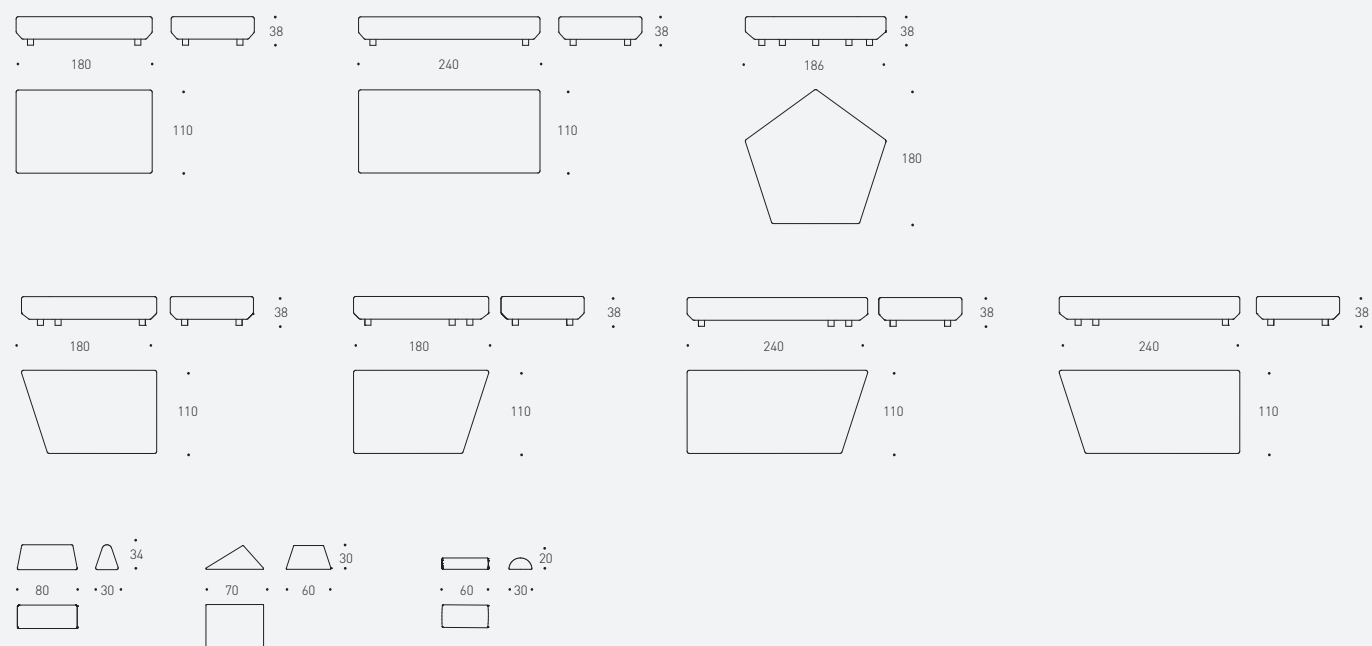



DIVANO BENTO - TAVOLINO BELT / BENTO SOFA - BELT COFFEE TABLE



DIVANO BENTO - TAVOLINO BELT - PANCA SYSTEM - BERGÈRE RELAX E TAVOLINO SUMMER SET /
BENTO SOFA - BELT COFFEE TABLE - SYSTEM BENCH - SUMMER SET BERGÈRE RELAX AND COFFEE TABLE



BERGÈRE RELAX E TAVOLINO SUMMER SET / SUMMER SET BERGÈRE RELAX AND COFFEE TABLE

PIPER MARMO

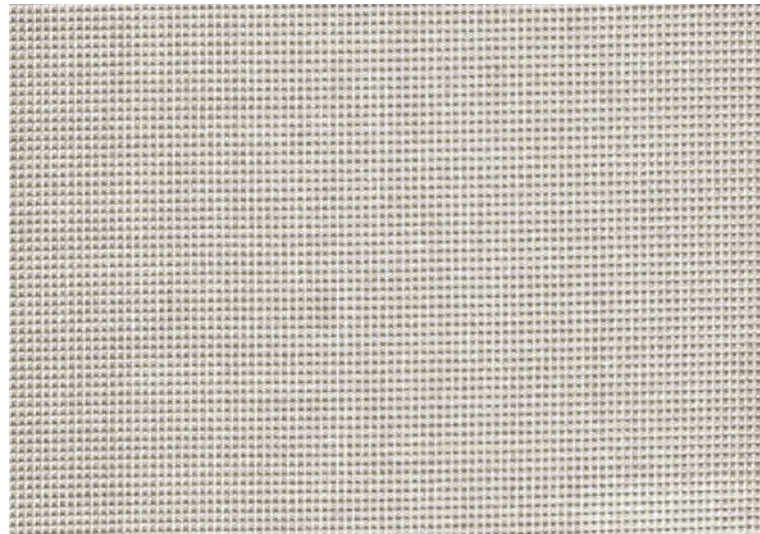

BENTO STYLE MOOD



ABACO OCEANO



VEGETAL ARTIC

ALLUMINIO BRONZO
BRONZE ALUMINIUM

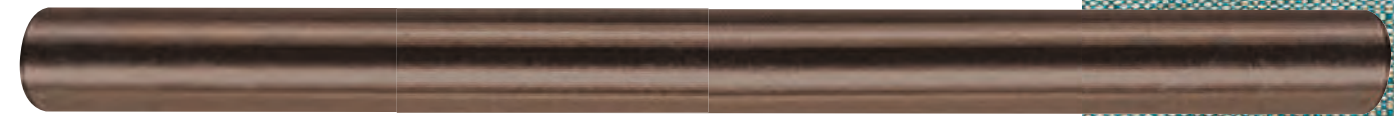

HPL CEMENTO

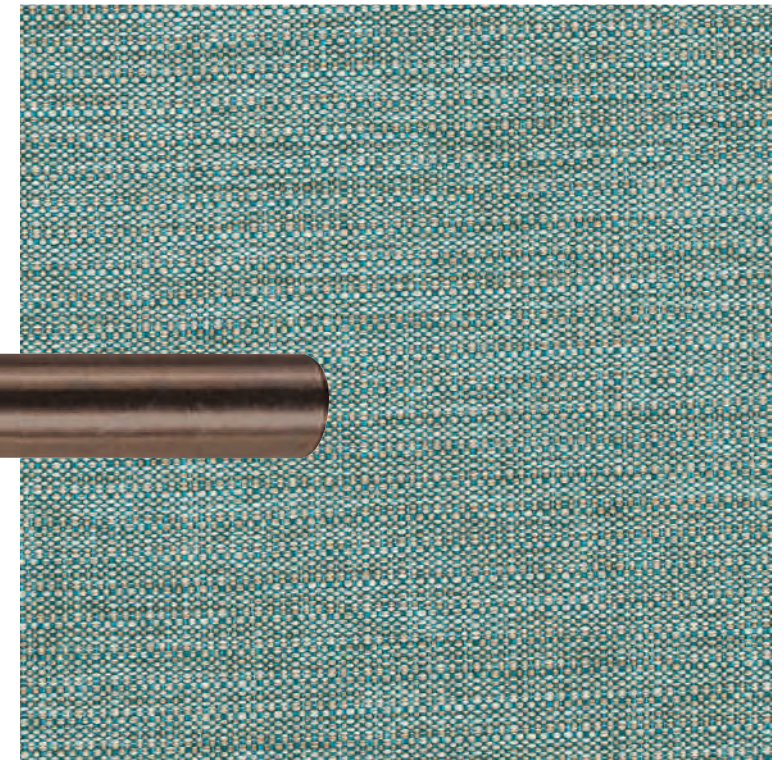

MARINE NAVY

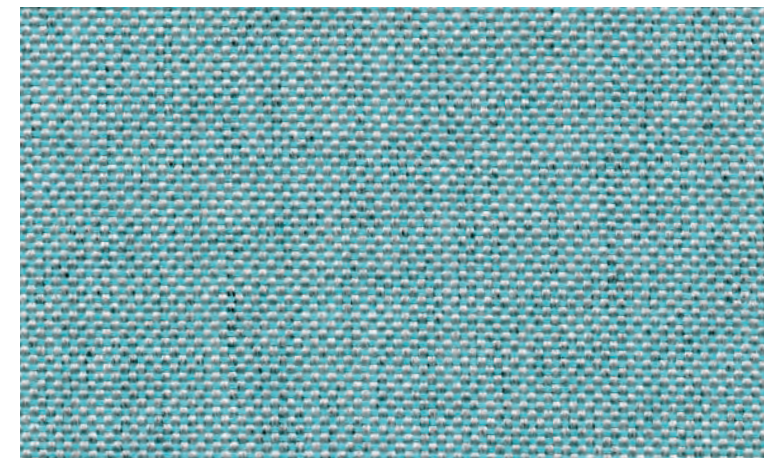

CANVAS OCEANO

HIGH STANDARD S-LOW LIFE

Non solo prodotto, ma concetto.
Pochi centimetri fanno la differenza nello stare a tavola.
L'altezza ridotta dei tavoli abbinati alle sedute lounge
sviluppa una nuova modalità di relazione, unicamente
outdoor.

Lo sviluppo della collezione Low è il fulcro
per una nuova definizione di convivialità, intimità
e qualità di relazioni. La linea di orizzonte si abbassa,
la prospettiva è dinamica, la terra è più vicina,
l'approccio alla natura è più diretto.
Una nuova filosofia di seduta conferma
che il mondo outdoor è poesia.

*Not only product but concept.
Few centimeters make the difference when dining.
The reduced table height combined with lounge seats
develops a new relationship mode, uniquely outdoor.
The development of the Low collection
is the centerpiece for a new definition of conviviality,
intimacy and quality of relationships.
The horizon line is lowered, the perspective is dynamic,
the earth is closer, the approach to nature is more direct.
A new seating philosophy confirms
that the outdoor world is poetry.*



LOW TABLES H67

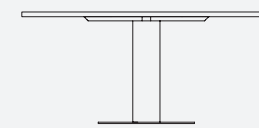

BIG LOW

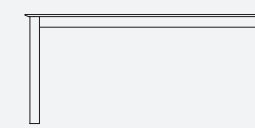

SYSTEM LOW

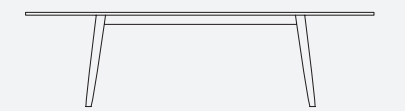

ELLISSE LOW

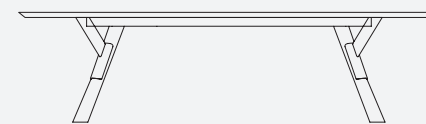

LINK LOW

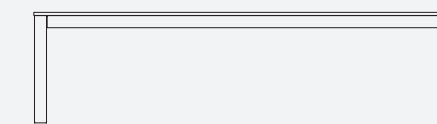

VICTOR LOW

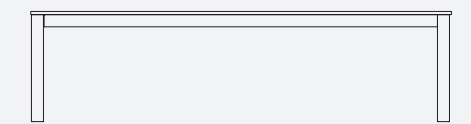

DOLMEN LOW

POLTRONE LOUNGE CLEVER - TAVOLO LOW BIG / CLEVER LOUNGE ARMCHAIRS - BIG LOW TABLE



LOW ARMCHAIRS H40

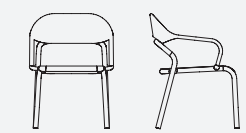

NOSS

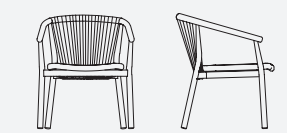

SMART

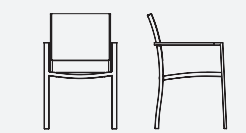

VICTOR



CRICKET

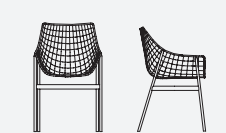

SUMMER SET

POLTRONCINE LOW SMART - TAVOLO LOW ELLISSE / SMART LOW ARMCHAIRS - ELLISSE LOW TABLE



LOUNGE ARMCHAIRS H40

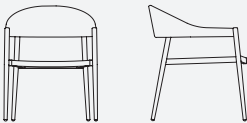

CLEVER



SMART

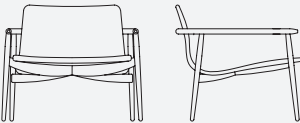

LAPIS

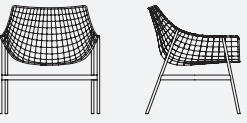

SUMMER SET



CRICKET

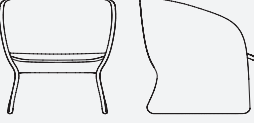

MAAT

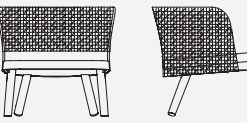

EMMA

POLTRONE LOUNGE LAPIS - TAVOLO LOW ELLISSE / LAPIS LOUNGE ARMCHAIRS - ELLISSE LOW TABLE



TAILOR ATTITUDE

Il rivestimento dei prodotti è un abito che si rinnova continuamente. La matericità si rinnova e si arricchisce di nuove decorazioni in abbinamento alle finiture delle collezioni. La nostra proposta tessile aggiunge carattere ed estende la percezione visiva di alcuni temi che sono realizzati esclusivamente per voi. Un lavoro di ricerca estetica traduce in nuove geometrie e fantasie colore che esprimono l'attitudine sartoriale, ma allo stesso tempo garantiscono performance qualitative che in ambiente outdoor sono necessarie e funzionali per un prodotto di qualità.

The upholstery of products is like a dress that is continually renewed. The texture is renewed and enriched with new decorations combined with the finishes of the collections. Our textile proposal adds character and extends the visual perception of some themes that are made exclusively for you. A work of aesthetic research translates into new geometries and color patterns that express the sartorial attitude but at the same time guarantees qualitative performance that in the outdoor environment are necessary and functional for a quality product.



TEXTILE COLLECTION

VEGETAL

DESIGN DANIELE LO SCALZO MOSCHERI



WHITE



BEIGE



PLATINO



ARTIC



ORANGE



ZINCO



OLIVA

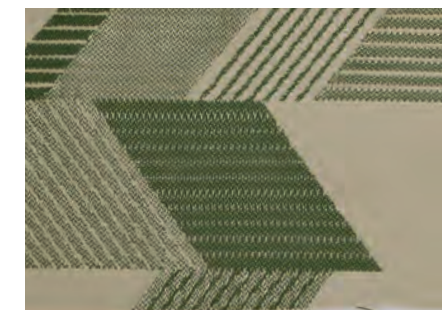

SAGE

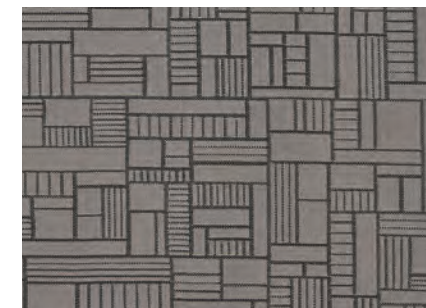

PIETRA



SABBIA



GREY



TEXTILE COLLECTION

VOGUE

VARASCHIN EXCLUSIVE



CRETA



NATTE



MONSTERA

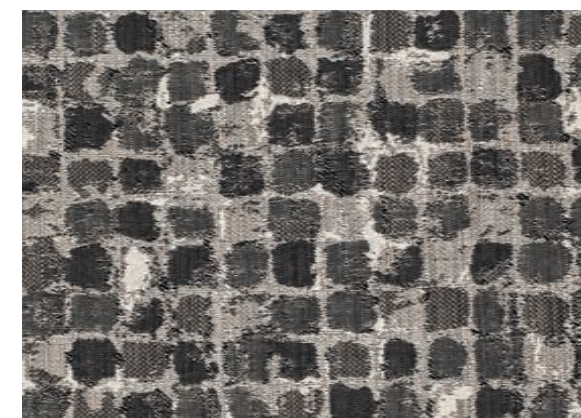

GRANITO

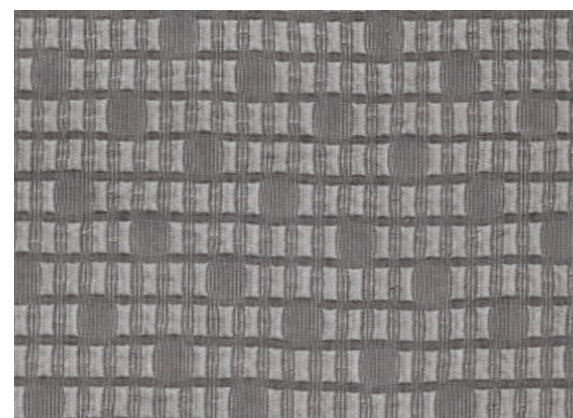

PIQUET



TEXTILE COLLECTION

MARINE

IMO - TEXTILE FOR CONTRACT



BEIGE



SACCO

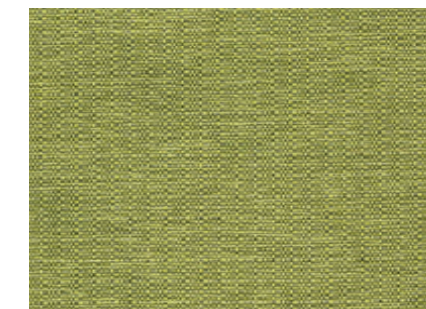

LIME

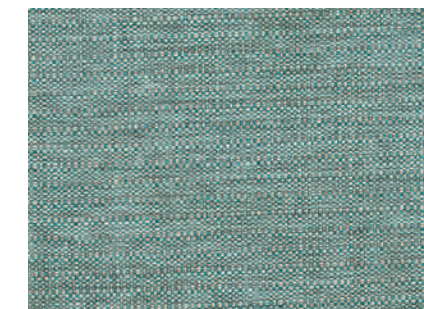

NAVY

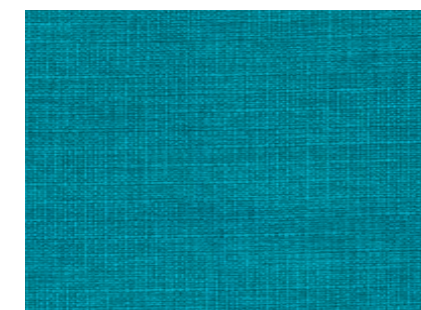

TURCHESE

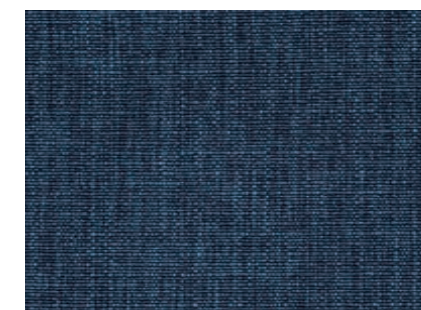

BLU



BRONZO



CARTAZUCCHERO



GRIGIO

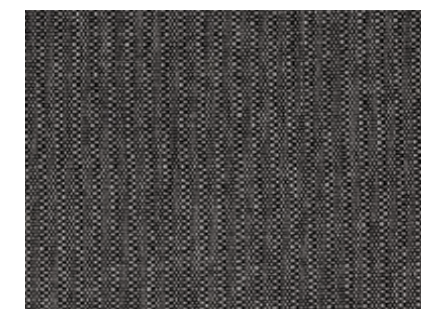

IRON



FUMO



CAFFÈ

HOLLAND AMERICA - VARASCHIN FURNITURE

AD	Daniele Lo Scalzo Moscheri
STYLING	Cora Vohwinkel / Irene Arescaldino
PHOTO	Gian Paolo Serna / Riccardo Stocco [assistente]
DRONE PHOTO	Claudio Zavagno / Andrea Tomio
FOTOLITO	lucegroup.it
STAMPA	sincromia.it cod.191218

Thanks LineMe

Stampa settembre 2019



Varaschin S.p.A
via Cervano 20 / 31029
Vittorio Veneto [TV] Italia

T 39 0438 56 45
F 39 0438 564 666

varaschin@varaschin.it
varaschin.it

VARASCHIN.IT