

Outdoor Decor  
Collections — 2021

ETHIMO

The background features a series of layered, wavy shapes in various shades of brown, red, pink, green, and teal, creating a textured, abstract landscape effect.

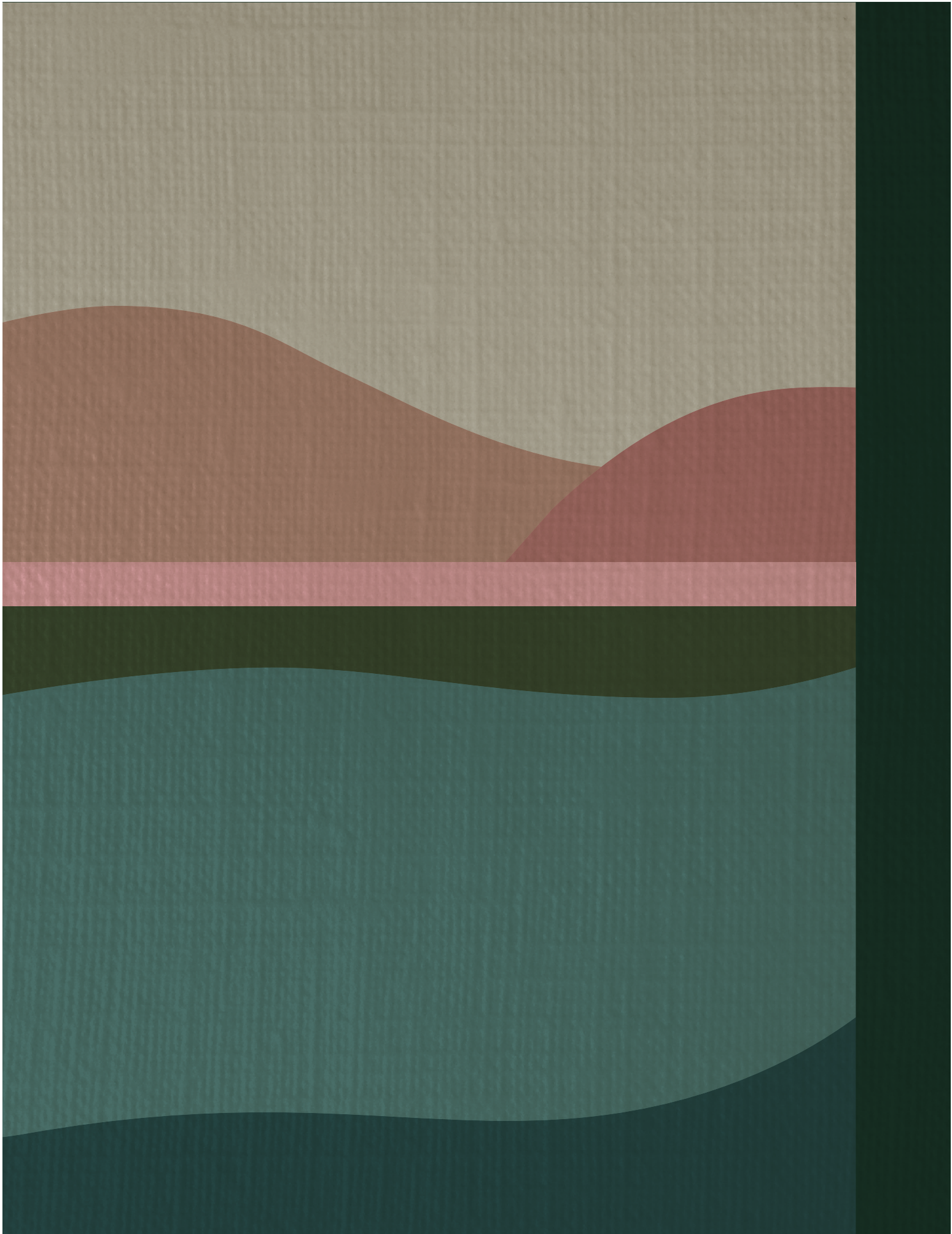





Outdoor Decor  
Collections — 2021

ETHIMO







Ritrovare il senso  
della vita, i colori delle stagioni,  
la bellezza di paesaggi  
familiari e straordinari.  
Coltivare una nuova  
e allo stesso tempo antica  
armonia con l'ambiente  
e con noi stessi, cogliere  
l'essenza delle cose  
e della vita.

Rediscovering a sense  
of life, seasonal colours,  
the beauty of familiar  
yet extraordinary landscapes.  
Cultivating harmony  
with the environment  
and with ourselves that is  
both new and ancient,  
embracing the essence  
of things and life.



Un nido  
accogliente.

A welcoming  
nest.

it / Un rifugio sicuro che accoglie e protegge, uno spazio vivo e ospitale, organizzato secondo regole sagge ed equilibrate. Il giardino dona un senso di serenità, sicurezza e libertà, invita a emozionarsi per un fiore che sboccia o un ramo che proietta trame di luce e ombre sul prato, dona ogni giorno piaceri che credevamo dimenticati, come dondolarsi su un'altalena o accoccolarsi in un nido. Ethimo interpreta il giardino e gli altri spazi dedicati alla vita all'aria aperta, con uno stile fondato sulla semplicità, l'armonia e il benessere. Un linguaggio inconfondibile e universale, con profonde radici nella terra e nel cuore.

en / A safe haven that welcomes and protects, a space that is alive and hospitable, organised according to rules that are wise and balanced. The garden lends a sense of serenity, security and freedom, it arouses our emotions at the sight of a flower in bloom or a branch casting a pattern of light and shadow on a lawn, every day bringing us pleasures we thought forgotten, like swinging on a swing or cuddling up in a nest. Ethimo interprets the garden and other spaces for outdoor living through a style based on simplicity, harmony and wellbeing. An unmistakable, universal language, deeply rooted in the land and the heart.









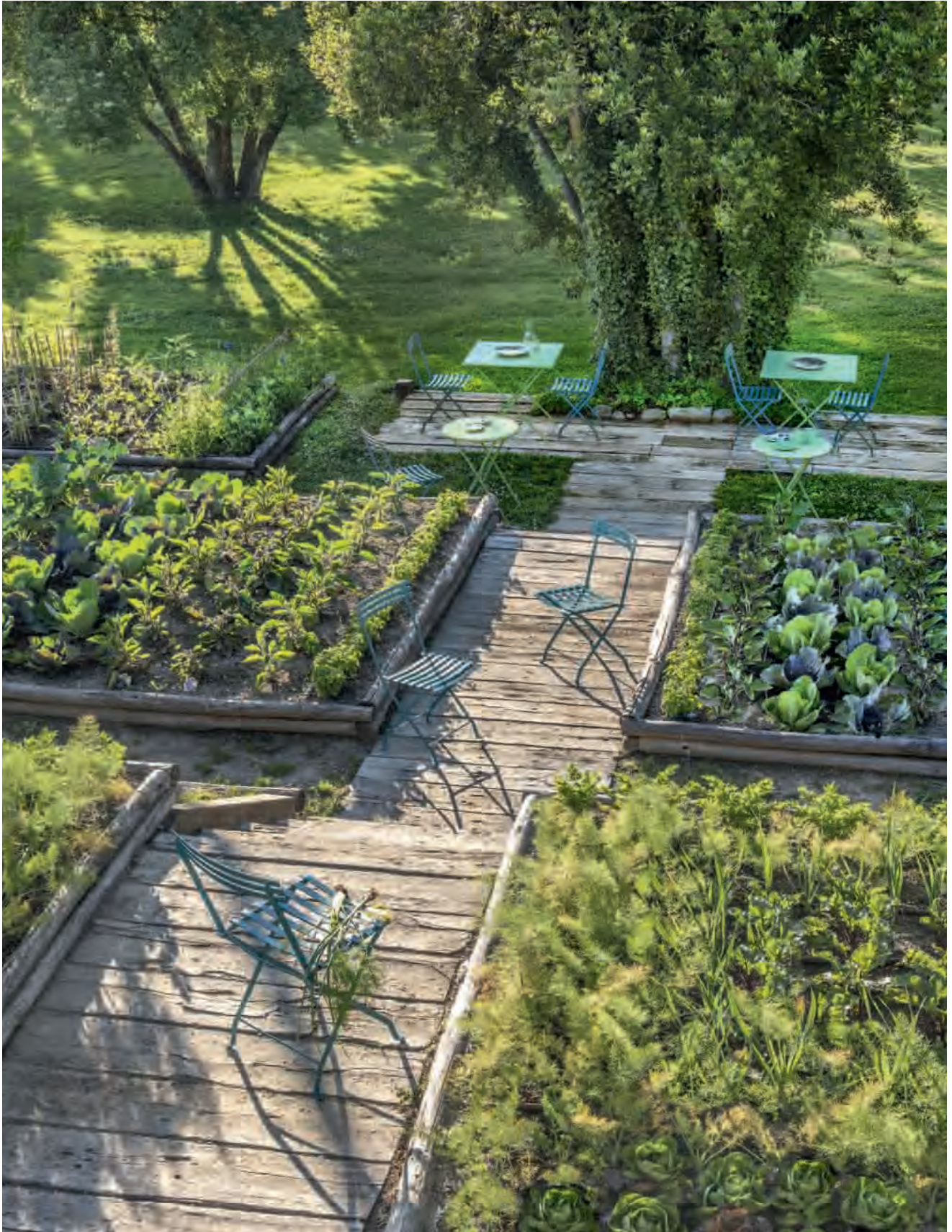



Un nid  
accueillant.

Ein behagliches  
Nest.

fr / Un havre de paix qui accueille et protège, un espace vivant et hospitalier, organisé selon des règles savantes et équilibrées. Le jardin donne un sentiment de sérénité, de sécurité et de liberté, il invite à s'émouvoir devant une fleur qui s'épanouit ou une branche qui crée un jeu de lumière et d'ombre sur le gazon, il procure chaque jour des plaisirs que l'on croyait oubliés, comme se balancer sur une balançoire ou se blottir dans un nid. Ethimo interprète le jardin et les autres espaces consacrés à la vie en plein air, dans un style basé sur la simplicité, l'harmonie et le bien-être. Un langage sans équivoque et universel, profondément enraciné dans la terre et dans le cœur.

de / Ein einladender Rückzugort, der ein Gefühl von Sicherheit und Geborgenheit vermittelt. Ein lebendiger und gastfreundlicher Raum, der nach umsichtigen und ausgewogenen Regeln organisiert ist. Der Garten vermittelt ein Gefühl von Gelassenheit, Geborgenheit und Freiheit, er lädt dazu ein, sich von einer blühenden Blume oder einem Zweig, der Licht und Schatten auf den Rasen wirft, bewegen zu lassen, er schenkt uns jeden Tag vergessen geglaubte Freuden, wie das Schwingen auf einer Schaukel oder das sich Hineinkuscheln in ein Nest. Ethimo interpretiert den Garten und andere dem Leben im Freien gewidmete Bereiche mit einem Stil, der auf Einfachheit, Harmonie und Wohlbefinden beruht. Eine unverwechselbare und universelle Ausdrucksweise, die tief in unserer Welt und im Herzen verwurzelt ist.









A photograph of an outdoor terrace. In the foreground, there are three round tables with metal frames and matching chairs. Each table is set with a plate of food and two glasses. The terrace is situated on a gravel surface, partially shaded by large, leafy trees. In the background, a stone wall and a metal railing separate the terrace from a vast, green valley. The valley features rolling hills, a line of cypress trees, and a small town in the distance. The overall atmosphere is peaceful and scenic.

Un terrazzo sul verde infinito,  
uno scenario che trasmette  
serenità e benessere.

A terrace looking out  
onto never-ending greenery,  
a view that creates feelings  
of serenity and wellbeing.







Un viaggio attraverso  
specie mediterranee  
ed esotiche, l'architettura,  
la storia. Un ambiente unico  
al mondo, un'armonia ideale  
fra le emozioni umane  
e le meraviglie della natura.

Exploring Mediterranean  
and exotic plants,  
architecture and history.  
An environment like no other  
in the world, ideal accord  
between human emotions  
and the wonders of nature.

Il mondo  
naturale.

The natural  
world.

it / L'Orto Botanico di Palermo, definito da Goethe "il luogo più stupendo del mondo", è insieme alla verde Toscana uno degli scenari della collezione Ethimo. Nel cuore del Mediterraneo, altra inesauribile fonte di ispirazione per Ethimo, con le sue memorie avventurose di viaggi e scoperte, la sua architettura in stile neoclassico e il suo tesoro di migliaia e migliaia di specie, è un inno alla biodiversità del pianeta, un museo vivente che spazia dalle emozioni intense e misteriose della giungla, alla spiritualità zen del bambù, ai profumi degli agrumi di Sicilia. Una molteplicità di sensazioni e linguaggi che trovano nella collezione Ethimo una sintesi altrettanto eclettica e in continua evoluzione.

en / Together with green Tuscany, the Botanical Gardens in Palermo, which Goethe called "the most wonderful place in the world", are one of the backdrops chosen for the Ethimo collection. In the heart of the Mediterranean, another unlimited source of inspiration for Ethimo, with its adventurous memories of travel and discovery, neoclassic architecture, this treasure trove with its thousands and thousands of species is an ode to the planet's biodiversity, a living museum that ranges from the intense mysterious emotions of the jungle, to the zen spirituality of bamboo and the citrus scent of Sicily. A plethora of sensations and languages that, in the Ethimo collection, find equally eclectic, continually evolving fusion.









Una bellezza capace di stupire, raffinata nella sua semplicità, in armonia con l'habitat naturale e lo stile di vita contemporaneo.

Beauty that amazes, refined in its simplicity, in harmony with the natural habitat and a contemporary lifestyle.













Le monde  
naturel.

Die Welt  
der Natur.

fr / Le Jardin botanique de Palerme, défini par Goethe comme « l'endroit le plus merveilleux du monde », est, avec la verte Toscane, un des décors de la collection Ethimo. Situé au cœur de la Méditerranée, autre source d'inspiration inépuisable pour Ethimo, avec ses souvenirs aventureux de voyages et de découvertes, son architecture néoclassique et son trésor composé de milliers d'espèces, le jardin est un hymne à la biodiversité de la planète, un musée vivant où se mêlent les émotions intenses et mystérieuses de la jungle, la spiritualité zen du bambou et les parfums des agrumes de Sicile. Une multiplicité de sensations et de langages qui trouvent dans la collection Ethimo une synthèse tout aussi éclectique et en constante évolution.

de / Der Botanische Garten von Palermo, den Goethe als „den schönsten Ort der Welt“ bezeichnete, bildet zusammen mit dem Landschaftsbild der Toskana eine der Kulissen für die Kollektion von Ethimo. Im Herzen des Mittelmeerraums bietet sich anhand seiner abenteuerlichen Erinnerungen an Reisen und Entdeckungen, seiner neoklassizistischen Architektur und seines Schatzes von Abertausenden von Arten eine weitere unerschöpfliche Inspirationsquelle für Ethimo. Sie ist eine Hymne an die biologische Vielfalt des Planeten, ein lebendiges Museum, das von den intensiven und geheimnisvollen Emotionen des Dschungels über die Zen-Spiritualität des Bambus bis hin zu den Düften sizilianischer Zitrusfrüchte reicht. Eine Vielzahl von Empfindungen und Sprachen, die in der Kollektion von Ethimo eine ebenso eklektische wie sich ständig weiterentwickelnde Synthese finden.



Vivere le  
stagioni.

Living seasons  
to the full.

it / Ethimo è un concetto di outdoor che attraversa il tempo e lo spazio. D'estate e d'inverno, sul mare azzurro, fra colline verdeggianti o su un terrazzo baciato dal sole, così come nelle città, dove la vita all'aria aperta e il verde rivendicano una nuova centralità. L'arredo Ethimo è pensato per inserirsi armoniosamente in ogni contesto e per durare a lungo, grazie alla qualità del progetto e dei materiali. Anche fra i boschi e cime innevate delle montagne, un altro habitat ideale per le collezioni Ethimo, interpretato con sapiente equilibrio fra tradizione e modernità, calore naturale ed eleganza sofisticata.

en / Ethimo is an outdoor concept that transcends time and space. Summer and winter, on the blue sea, amidst green hills, on a sun-kissed terrace, or even in a city, where life in the open air and vegetation lay claim to a new focus. Ethimo furnishings are designed to fit beautifully into any context and last at length, thanks to the quality of the project and its materials. Up in the mountains, surrounded by woods and snowy peaks; another ideal habitat for Ethimo collections, interpreted with a skilful equilibrium that is all about tradition and modernity, natural warmth and sophisticated elegance.













Vivre les  
saisons.

Erleben Sie die  
Jahreszeiten.

fr / Ethimo est un concept de plein air qui traverse le temps et l'espace. Que l'on soit en été ou en hiver, au bord de la mer bleue, au milieu des collines verdoyantes ou sur une terrasse ensoleillée, ou même en ville, où la vie en plein air et les espaces verts revendiquent une nouvelle centralité. Le mobilier Ethimo est conçu pour s'intégrer harmonieusement dans n'importe quel contexte et pour durer longtemps, grâce à la qualité de son design et de ses matériaux. Qu'il s'agisse des bois ou des sommets enneigés des montagnes, un autre habitat idéal pour les collections Ethimo, interprété dans un savant équilibre entre tradition et modernité, chaleur naturelle et élégance sophistiquée.

de / Das Outdoor-Konzept von Ethimo durchquert Zeit und Raum. Im Sommer wie im Winter, am blauen Meer, zwischen grünen Hügeln oder auf einer sonnigen Terrasse, aber auch in den Städten, wo das Leben im Freien und die Grünflächen eine neue Bedeutung erlangen. Die Möbel von Ethimo sind so konzipiert, dass sie sich harmonisch in jede Umgebung einfügen und dank der Qualität des Designs und der Materialien eine lange Lebensdauer haben. Auch zwischen den Wäldern und schneebedeckten Berggipfeln finden die Kollektionen von Ethimo einen idealen Standort, indem sie mit einem klugen Gleichgewicht zwischen Tradition und Moderne, natürlicher Wärme und raffinierter Eleganz interpretiert werden.





# Index



Venexia  
– p 28

Lounge armchair  
/ Sofa Modular  
/ Sofa / Coffee table



Rafael  
– p 36

Lounge armchair  
/ Daybed / Modular  
sofa / Armchair  
/ Table / Sunbed  
/ Coffee table



Hut  
– p 46

Alcove



Grand Life  
– p 50

Lounge armchair  
/ Sofa / Bergère  
/ Sunbed / Coffee  
table



Swing  
– p 56

Lounge armchair  
/ Sofa / Modular  
sofa / Club armchair  
/ Coffee table  
/ Table / Armchair  
/ Porch swing



Allaperto  
– p 66

Lounge armchair  
/ Sofa / Coffee  
table / Sunbed  
/ Lounge bed  
/ Swing



Knit  
– p 78

Lounge armchair  
/ Sofa / Footstool  
/ Rocking armchair  
/ Coffee table  
/ Table / Chair  
/ Armchair / Sunbed



Esedra  
– p 88

Lounge armchair  
/ Sofa / Coffee  
table / Armchair  
/ Table / Sunbed



Concreto  
– p 96

Table / High table



Pluvia  
– p 96

Armchair



Kilt  
– p 100

Lounge armchair  
/ Sofa / Coffee  
table / Armchair  
/ Table



Ribot  
– p 106

Lounge armchair  
/ Stool / Coffee  
table / Armchair  
/ Table / Chair  
/ Barstool



Agave  
– p 110

Lounge chair  
/ Chair / Coffee  
table / Table



Costes  
– p 114

Lounge armchair  
/ Sofa / Modular  
sofa / Coffee table  
/ Armchair / Table  
/ Sunbed



Play  
– p 120

Table / Ping pong  
table





Nicolette  
– p 124

Armchair / Barstool



Enjoy  
– p 126

Coffee table  
/ Lounge dining  
table / Table



Flat  
– p 128

Table



Studios  
– p 128

Armchair



Infinity  
– p 130

Lounge armchair  
/ Sofa / Modular  
sofa / Coffee table  
/ Sunbed



Ocean / Smart  
– p 134

Sunbed  
/ Side table



Essenza  
– p 136

Sun lounger  
/ Lounge bed



Cronos  
– p 138

Table



Friends  
– p 140

Table



Elle  
– p 142

Deck chair



Elit  
– p 143

Sunbed



Cruise  
– p 144

Deck chair



Notting Hill  
– p 145

Armchair  
/ Bench



T-Box  
– p 270

Trunk



Sand  
– p 146

Sunbed



# Index



Sandy  
– p 146

Backrest



Petit club  
– p 270

Coffee table



Clay  
– p 270

Coffee table



Elisir  
– p 150

Lounge armchair  
/ Sofa / Coffee  
table / Armchair /  
Chair / Table  
/ Sunbed



Laren  
– p 156

Armchair / Chair  
/ Barstool / Table  
/ High table



Flower  
– p 162

Armchair / Chair  
/ Barstool / Table  
/ High table



Phorma / Loto  
– p 166

Lounge armchair  
/ Sofa / Coffee  
table



Cube  
– p 168

Lounge armchair  
/ Sofa / Modular  
sofa / Footstool  
/ Pouf / Sunbed  
/ Coffee table



Holiday  
– p 172

Wooden umbrella



Freedom  
– p 173

Aluminium  
adjustable  
umbrella



Classic  
– p 174

Wooden umbrella



Free  
– p 176

Aluminium  
umbrella



Clostra  
– p 178

Shield  
/ Planter



Rug  
– p 180

Outdoor rug



Lucerna  
– p 182

Rechargeable  
lantern / Wired  
lantern





Pharos  
– p 184

Lamp post  
/ Wall lamp post



Milk  
– p 186

Portable solar  
lamp



Shake  
– p 187

Floor lamp



Carré  
– p 188

Wall lamp / Table  
lamp / Floor lamp  
/ Bollard



Ginger  
– p 190

Wall lamp  
/ Table lamp  
/ Floor lamp



Step  
– p 191

Path lamp



Eivissa  
– p 192

Pavillions







Ethimo.  
Le collezioni.  
The collections.  
Les collections.  
Die Kollektionen.







# Venexia

Collection composed of:  
lounge armchair / 2 seater sofa  
/ back end module / cup holder  
/ coffee table.

# Luca Nichetto

it / L'eleganza degli arredi urbani del tardo Ottocento rivive in un progetto che unisce fascino intramontabile e moderna funzionalità. La struttura in alluminio, che ricorda visivamente le antiche ringhiere, caratterizza i divani e la poltrona, avvolgendo le forme ampie e arrotondate della seduta con una sensazione di leggerezza e robustezza al tempo stesso. Le generose proporzioni dei cuscini sono amplificate dalle morbide texture dei rivestimenti tenui nelle nuance.

en / The elegance of the urban furniture of the late nineteenth century revives in a project that combines timeless charm and modern functionality. The aluminium structure that visually recalls the ancient railings, characterizes the sofas and the armchair, enveloping the generous and rounded forms of the seat with a feeling of lightness and robustness at the same time. The wide proportions of the cushions are amplified by the soft textures of the pale coverings in the nuances.

Technical info pp.220





# Venexia

it / La modularità degli elementi consente diverse composizioni, con un raffinato senso dell'armonia. I daybed si uniscono creando sedute accoglienti, in cui i soffici cuscini sono sorretti dalla leggera alternanza simmetrica della struttura in alluminio.

en / The modularity of the elements allows different compositions, with a refined sense of harmony. The daybeds come together to create cozy seats, in which the soft cushions are supported by the slight symmetrical alternation of the aluminium structure.

Technical info pp.220



Poggia bicchiere  
in teak decapato.  
/ Cup holder  
in pickled teak.











# Venexia

# Luca Nichetto

it / Il design di Venexia armonizza il classico e il contemporaneo. Il frame in alluminio ha un aspetto leggero ed arioso, sottolineando il comfort delle sedute e la matericità dei top dei tavolini, per uno stile inconfondibile.

en / Venexia's design harmonizes the classic and the contemporary. The aluminium frame has a light and airy look, emphasizing the comfort of seats and the materiality of the tops of the tables, for a unique style.

Technical info pp.220









Venexia





# Rafael

Collection composed of:  
loung armchair / daybed  
/ lounge armchair with integrated  
coffee table / coffee table  
/ sunbed / dining table  
/ dining armchair.

# Paola Navone

it / Rafael è una collezione dall'aspetto insolito e fortemente caratterizzante, suggerita dalla poliedricità e impermanenza della natura. La robusta struttura in teak spazzolato, con graffe in metallo brunito che aggiungono un tocco di artigianalità, incontra le texture e le tonalità dei cuscini, in un dialogo compositivo nel quale si inseriscono i tavoli in candido marmo o pietra smaltata nel colore del mare.

en / Rafael is a collection with an unusual appearance and strong character, influenced by the versatility and transience of nature. The sturdy structure in brushed teak, with metal staples that add a touch of craftsmanship, meets the textures and shades of the cushions, in a compositional dialogue in which the tables in white marble or stone glazed in the color of the sea are inserted.

Technical info pp.222



Daybed in teak naturale spazzolato.  
Cuscini Mood Laguna.  
/ Daybed in brushed natural teak, Laguna Mood cushions.











Rafael









# Rafael

# Paola Navone

it / La forma destrutturata dei lettini racconta l'essenza un po' tribale che caratterizza l'intera collezione. Gli ampi e soffici cuscini accolgono il corpo in un piacevole effetto cocooning.

en / The unstructured shape of the sun loungers tells the slight tribal essence that characterizes the entire collection. The wide and soft cushions welcome the body in a pleasant cocooning effect.

Technical info pp.222









# Rafael

it / L'irregolarità del disegno caratterizza l'asimmetria dei piani dei tavoli, che abbinano forme inattese a materiali primordiali come la pietra lavica e il marmo statuario.

en / The irregularity of the design characterizes the asymmetry of the table tops, which combine unexpected shapes with primordial materials like lava stone and statuary marble.

Technical info pp.222



Tavolo con piano asimmetrico in pietra lavica smaltata smeraldo. Dettaglio in marmo statuario.  
/ Dining table with asymmetrical top in smeraldo lava stone. Detail in statuary marble.



## Rafael

## Paola Navone

it / Il sofisticato gioco di intrecci delle sedute esprime l'essenza eclettica dell'intera collezione. Confortevoli ed ergonomiche, le poltroncine si abbinano naturalmente all'irregolare geometria dei tavoli, creando dining set esclusivi e contemporanei.

en / The sophisticated interweaving of the seats expresses the eclectic essence of the entire collection. Comfortable and ergonomic, the armchairs match naturally to the irregular geometry of the tables, creating exclusive and contemporary dining sets.

Technical info pp.222



Poltroncina dining  
e tavolo ottagonale in teak  
spazzolato naturale  
e piano in marmo  
statuario.  
/ Dining chairs and  
octagonal dining table in  
brushed natural teak and  
statuary marble top.











# Hut

Collection composed of:  
alcove.

# Atelier Lavit

it / Un istante fuori dal tempo, uno spazio intimo e protetto dove ritrovare se stessi. Realizzato in Accoya® e alluminio, Hut ha dimensioni importanti e un'anima eco-sostenibile per vivere appieno il contatto con la natura.

en / An instant out of time, an intimate and protected space where you can find yourself. Made of Accoya® and aluminium, Hut has important dimensions and an eco-sustainable soul to fully experience contact with nature.

Technical info pp.227





# Hut





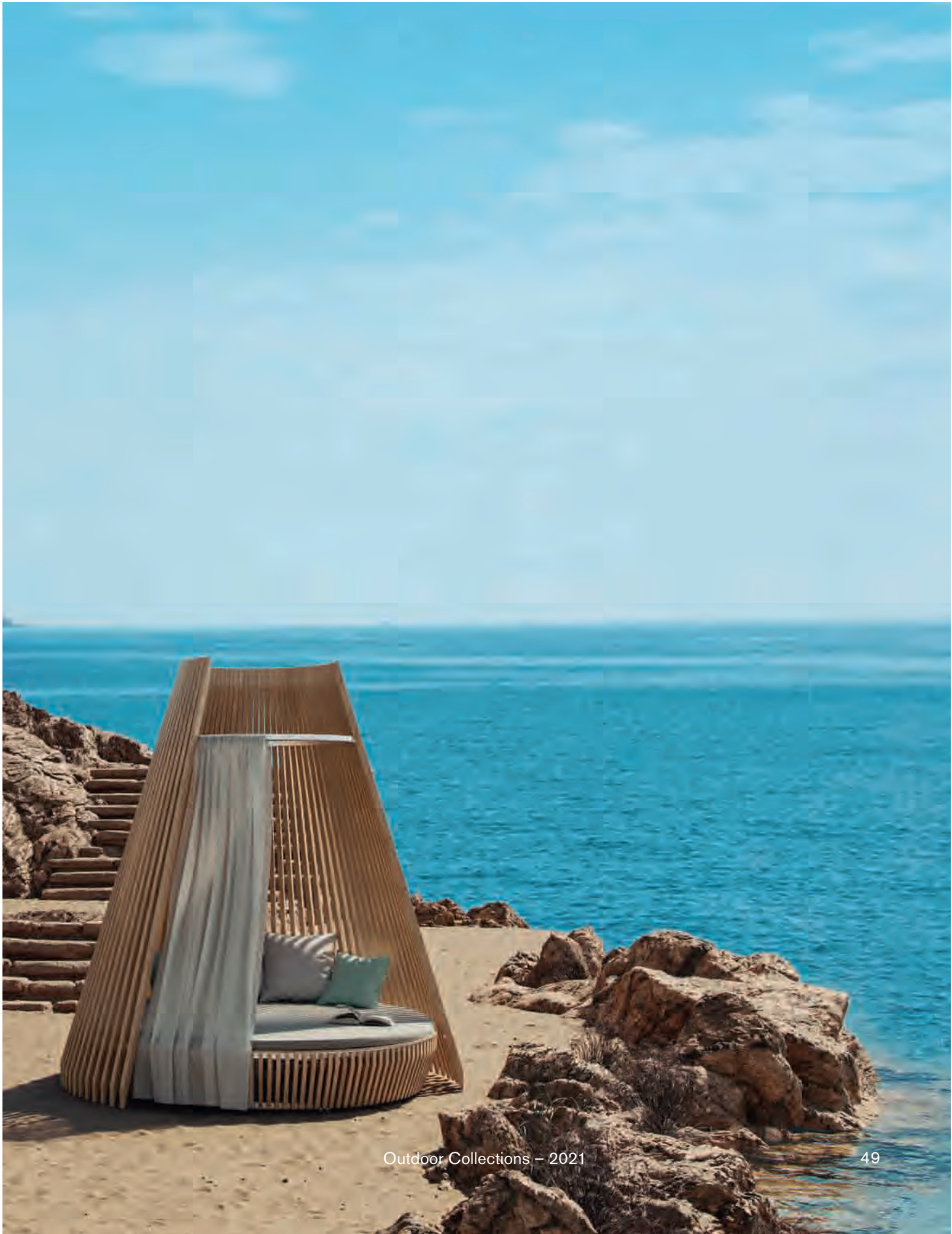







## Grand Life

Collection composed of:  
bergère / lounge armchair  
/ XL sofa / coffee table  
/ sunbed.

## Christophe Pillet

it / Dallo stile sartoriale e dalle linee pure, Grand Life è una collezione di sedute lounge con struttura in teak e corda intrecciata. Le ampie proporzioni e i soffici cuscini sottolineano il senso di comfort e di benessere. Una collezione concepita come omaggio all'eleganza italiana senza tempo.

en / With a sartorial style and pure lines, Grand Life is a collection of lounge chairs with structure in teak and woven rope. The wide proportions and the soft cushions emphasize a sense of comfort and well-being. A collection conceived as a tribute to timeless Italian elegance.

Technical info pp.228









# Grand Life





# Grand Life

# Christophe Pillet

it / L'artigianalità dell'intreccio rievoca la tessitura dell'antica paglia di Vienna, conferendo un'elegante personalità a questa collezione che invita a vivere in armonia con la natura.

en / The craftsmanship of the braiding evokes weaving of the ancient Vienna straw, giving an elegant personality to this collection that invites you to live in harmony with nature.

Technical info pp.228



Lettino e lounge set  
in teak e corda intrecciata.  
Tavolini con piano  
in pietra ceramica.  
/ Sun lounger and lounge  
set in teak and woven  
rope. Coffee tables with  
ceramic stone top.







# Swing

Collection composed of: lounge  
armchair / 2 seater sofa  
/ xl sofa / modular sofa  
/ club armchair / porch swing  
/ coffee table / barstool / dining  
armchair / dining table / pouf.

# Patrick Norguet

it / Swing è come un nido che accoglie corpo e mente.  
Un raffinato concetto basato sul gioco di ripetizioni di  
una serie di elementi in teak, fissati su una struttura di  
alluminio, per infiniti momenti di vita all'aria aperta.

en / Swing is like a nest that embraces body and mind.  
A refined system based on a repetition game of a series  
of elements in teak, fixed on an aluminium structure,  
for endless moments of life in the open air.

Technical info pp.230



Sgabello e poltroncine  
in teak e alluminio.  
/ Barstools and club  
armchairs in teak  
and aluminium.











# Swing

it / I moduli si uniscono per creare sedute ampie ed accoglienti. Lo spazio cambia forma in base alle necessità.

en / The modules come together to create wide and welcoming seats. The space changes shape according to needs.

Technical info pp.230





# Swing

it / Il dondolo in metallo warmred è un'icona della collezione Swing. I lounge set creano raffinati salotti a cielo aperto.

en / The warmred metal porch swing is an icon of Swing collection. Lounge sets create refined open sky living rooms.

Technical info pp.230



Dondolo e salotto in teak con frame in alluminio.  
/ Porch swing and lounge set in teak with aluminium frame.











# Swing

# Patrick Norguet

it / I tavoli abbinano il teak e il metallo ripercorrendo il leit motiv materico che caratterizza tutta la linea. Disponibili in due forme diverse, creano perfetti momenti di convivialità a contatto con la natura.

en / The tables combine teak and metal retracing the material leit motif that characterizes the entire line. Available in two different shapes, they create perfect moments of conviviality in contact with nature.

Technical info pp.230





# Swing

it / I nuovi pouf Swing giocano su una ritmica alternanza di dimensioni e cromie, così come i tipici sassi che arricchiscono i fondali marini. I cuscini accolgono il corpo per piacevoli momenti di relax.

en / The new Swing poufs play on a rhythm alternation of sizes and colors, like the typical stones that enrich the seabed. The cushions welcome the body for pleasant moments of relaxation.

Technical info pp.230









# Allaperto

Collection composed of: lounge armchair / 2 seater sofa / square and rectangular coffee table / sunbed / lounge bed / hanging armchair / free-standing outdoor swings.

# Matteo Thun & Antonio Rodriguez

it / Allaperto è un'unica filosofia per cinque diversi outfits: Veranda, Nautic, Montagna, Camping Chic e Urban. Cambia l'aspetto ma non l'essenza. Il rattan naturale è protagonista del mood Veranda e ne esalta l'artigianalità dell'intreccio.

en / Allaperto is a single philosophy for five different outfits: Veranda, Nautic, Montagna, Camping Chic and Urban. The appearance changes but not the essence. Natural rattan is the protagonist of the Veranda mood and it enhances the craftsmanship of the weave.

Technical info pp.234

Allaperto Veranda. Sedute lounge e poltrona sospesa in teak e rattan naturale.  
/ Lounge seats and hanging armchair in teak and natural rattan.









# Allaperto Nautic

it / Nella versione Nautic la corda intrecciata racconta un mood legato alla vita di mare e assicura durabilità e resistenza.

en / In the Nautic version the woven rope tells a sea life mood and ensures durability and resistance.

Technical info pp.234









# Allaperto

it / La poltrona sospesa, disponibile anche nella versione altalena con struttura autoportante in metallo, abbina la fibra al teak dei braccioli. Una seduta dalle dimensioni accoglienti per dondolarsi all'aria aperta con movimenti leggeri nel massimo del comfort.

en / The suspended armchair, also available in the swing version with a self-supporting metal structure, combines the fiber with the teak of the armrests. A seat with a cozy size for rocking in the open air with light movements in maximum comfort.

Technical info pp.234



Allaperto Nautic.  
Altalena e poltrona  
sospesa in corda e teak.  
/ Free-standing outdoor  
swings and hanging  
armchair in flat rope  
and teak.











# Allaperto Mountain Etwick

## Matteo Thun & Antonio Rodriguez

it / Il Mountain mood di Allaperto abbina il teak al vivace tartan o alla sofisticata fibra corteccia. L'outdoor di montagna è un luogo speciale da vivere a contatto con la natura.

en / Allaperto's Mountain mood combines teak with lively tartan or sophisticated bark fiber. The mountain outdoors is a special place to live in contact with nature.

Technical info pp.234





# Allaperto Mountain Tartan

Allaperto Mountain.  
Salotto in teak e tessuto  
Ethitex tartan.  
/ Lounge set in teak  
and tartan Ethitex fabric.













# Allaperto Camping chic / Urban

## Matteo Thun & Antonio Rodriguez

it / Dai litorali assolati, agli skyline urbani, Camping Chic è colorato e vivace, Urban è elegante e sofisticato. Due look diversi in un'unica anima.

en / From sunny shores to urban skylines, Camping Chic is colorful and lively, Urban is elegant and sophisticated. Two different looks in one soul.

Technical info pp.234





# Knit

Collection composed of: armchair / 3 seater sofa / lounge armchair / 2 seater sofa / lounge high back armchair / rocking lounge armchair / footstool / coffee table / dining armchair / dining chair / square, rectangular and round dining table.

# Patrick Norguet

it / Sintesi di bellezza e funzionalità, Knit è una linea completa di arredi che nasce dall'incontro tra il teak e la corda intrecciata. L'avvolgente poltrona con schienale alto, il sofà, la rocking chair sono alcuni degli elementi di una proposta in costante evoluzione anche nelle finiture e nei colori.

en / A synthesis of beauty and functionality, Knit is a complete line of furniture that arises from the encounter between teak and woven rope. The enveloping high-back armchair, the sofa, the rocking chair are some of the elements of a proposal that is constantly evolving even in the finishes and colors.

Technical info pp.238













# Knit

it / Il divano a tre posti e la poltrona hanno forme sinuose che esaltano il connubio materico tra corda intrecciata e teak. Le morbide texture dei cuscini conferiscono maggiore comfort alle sedute, ergonomiche e sofisticate.

en / The three-seater sofa and the armchair have sinuous shapes that enhance the material union of woven rope and teak. The soft textures of the cushions give greater comfort to the ergonomic and sophisticated seats.

Technical info pp.238





# Knit

it / L'iconica poltrona highback della collezione Knit si trasforma in una elegante rocking chair. La corda intrecciata accoglie il corpo, mentre la mente si rilassa cullata da un dolce dondolio.

en / The iconic highback armchair from the Knit collection is transformed into an elegant rocking chair. The woven rope welcomes the body, while the mind relaxes lulled by a gentle rocking.

Technical info pp.238













# Knit

# Patrick Norguet

it / La corda light grey si accosta al teak decapato, esaltando le naturali venature del legno. Le sedute lounge e i dining set scandiscono momenti di rilassante convivialità.

en / The light grey rope is combined with pickled teak, enhancing the natural grain of the wood. The lounge seats and dining sets mark moments of relaxing conviviality.

Technical info pp.238







Tavoli rotondi in teak decapato. Poltroncine dining in teak e corda light grey.  
 / Round dining tables in pickled teak. Dining armchairs in teak and light grey flat rope.

Tavoli rettangolari in teak naturale. Poltroncine dining in teak e corda lava grey.  
 / Rectangular dining tables in natural teak. Dining armchairs in teak and lava grey flat rope.



Knit





# Esedra

Collection composed of:  
3 seater sofa / lounge armchair  
/ coffee table / square,  
rectangular and oval dining table  
/ dining armchair / sunbed.

# Luca Nichetto

it / Ispirata ad elementi dell'architettura classica,  
la collezione Esedra è icona dell'outdoor contemporaneo.  
Una linea completa di arredi in cui materiali diversi  
dialogano tra loro con eleganza e carattere.

en / Inspired by elements of classical architecture,  
the Esedra collection is an icon of contemporary outdoor.  
A complete line of furniture in which different materials  
combine with each other with elegance and character.

Technical info pp.242













# Esedra

it / Il divano e le poltrone sono come nicchie accoglienti, in cui l'intreccio della fibra esalta l'artigianalità della collezione, abbinandosi con armonia al metallo e al teak della struttura.

en / The sofa and armchairs are like welcoming niches, in which the interweaving of the fiber enhances the craftsmanship of the collection, harmoniously combining with the metal and teak of the structure.

Technical info pp.242

Salotto e dining set in fibra Natwick e alluminio. Tavolo e tavolini con piano in teak decapato. / Lounge and dining sets in aluminium and Natwick wide weave. Table and coffee tables with pickled teak tops.

Tavolini rotondi e quadrati con piano in teak o pietra ceramica. Frame in alluminio. / Round and rectangular coffee tables with teak or ceramic stone top. Aluminium frame.









# Esedra

# Luca Nichetto

it / Le forme avvolgenti caratterizzano tutti gli elementi lounge della collezione. Il lettino prendisole ha profili sinuosi e morbidi cuscini in cui l'alternanza materica è protagonista.

en / The enveloping shapes characterize all the lounge elements of the collection. The sun lounger has sinuous profiles and soft cushions in which the alternation of materials is the protagonist.

Technical info pp.242





# Esedra

it / Ovale, rettangolare o quadrato, il tavolo Esedra ha un design essenziale, in cui i profili in alluminio esaltano la matericità del teak decapato che compone i piani.

en / Oval, rectangular or square, the Esedra table has an essential design, in which the aluminium profiles enhance the materiality of the pickled teak that makes up the tops.

Technical info pp.242













# Concreto / Pluvia

Collection composed of:  
Concreto – dining table  
/ high table.

Pluvia – Natwick dining  
armchair / round rope dining  
armchair.

## Luca Nichetto

it / La collezione Concreto reinterpreta in chiave contemporanea il tavolo da bistrot. Il cemento della base si abbina al frame in metallo e ai piani in teak e laminato, creando un elemento dall'estetica pura e raffinata.

La poltroncina Pluvia, ispirata alle sedute anni '80, veste la struttura in alluminio con l'artigianalità dell'intreccio tricot. Ergonomica e impilabile, è un perfetto connubio di estetica e funzionalità.

en / The Concreto collection reinterprets the bistro table in a contemporary way. The concrete of the base matches the metal frame and the teak and laminate tops, creating an element with a pure and refined aesthetic.

The Pluvia armchair, inspired by the 80's seats, dresses the aluminium structure with the craftsmanship of the tricot weave. Ergonomic and stackable, it is a perfect combination of aesthetics and functionality.

Technical info pp.246–249







# Concreto / Pluvia

it / I tavoli Concreto, sia con piano quadrato che rotondo, sono disponibili in diverse altezze. La poltroncina Pluvia spazia tra le cromie del nero e del sabbia.

en / Concreto tables, both with square and round tops, are available in different heights. The Pluvia armchair ranges between the colors of black and sand.

Technical info pp.246-249









# Kilt

Collection composed of: teak dining armchair / stainless steel dining armchair / 2 seater sofa / lounge armchair / coffee table / dining table.

# Marcello Ziliani

it / Nella collezione Kilt la corda intrecciata tende la sua fitta trama per abbracciare le venature del teak.

en / In the Kilt collection the braided rope stretches its thick texture to embrace the texture of the teak.

Technical info pp.248









# Kilt

it / La natura si fa design. La corda si colora di un intenso Ruby wine e di un brillante Olive green, esaltando l'artigianalità dell'intreccio e la matericità del legno.

en / Nature becomes design. The rope is colored with an intense Ruby wine and a brilliant Olive green, enhancing the craftsmanship of the weave and the materiality of the wood.

Technical info pp.249





# Kilt

## Marcello Ziliani

it / La poltroncina dining si trasforma in un'accogliente seduta lounge, creando un riuscito mix di eleganza, ergonomia e funzionalità. Nella sua variante in teak decapato e corda dark grey, Kilt si inserisce perfettamente nei paesaggi d'alta quota.

en / The dining armchair is transformed into a welcoming lounge seat, creating a successful mix of elegance, ergonomics and functionality. In its pickled teak and dark grey rope variant, Kilt fits perfectly into high-altitude landscapes.

Technical info pp.249









# Ribot

Collection composed of:  
rectangular extendable table  
/ dining armchair / dining chair  
/ lounge armchair / footstool  
/ coffee table / counter stool  
/ barstool.

# Marc Sadler

it / Equilibrato esempio di estetica e funzionalità, la collezione Ribot disegna un elegante utilizzo del teak. Il tavolo allungabile (fino a 340 cm) e le poltroncine dining si legano in un'armonica soluzione di continuità materica. Le sedute lounge seguono la pulizia formale del disegno, vestendosi con confortevoli cuscini seduta. Gli sgabelli bistrot, novità 2021, introducono l'utilizzo dell'acciaio inox, creando un connubio materico sofisticato.

en / Balanced example of aesthetics and functionality, the Ribot collection draws an elegant use of teak. The extendable table (up to 340 cm) and the dining armchairs are linked in a harmonious solution of material continuity. The lounge chairs follow the formal cleanliness of the design, dressing up with comfortable seat cushions. The bistro stools, new for 2021, introduce the use of stainless steel, creating a sophisticated combination of materials.

Technical info pp.250



Sedute lounge e sgabelli  
in teak naturale.  
Dettagli in acciaio inox.  
/ Lounge armchairs and  
barstools in natural teak.  
Stainless steel details.







Ribot













# Agave

Collection composed of: lounge chair / coffee table / dining chair / round, square and rectangular dining table.

# Mattia Albicini

it / Il teak massello, che caratterizza i tavoli e le sedute dell'intera collezione, ha bordi sottili e curve morbide che invitano a sedersi. La mente ripercorre i mitici anni '60, mentre la lavorazione del legno parla di sofisticata contemporaneità. Agave è una collezione che invita ad una convivialità rilassata ed elegante.

en / The solid teak, which characterizes the tables and seats of the entire collection, has thin edges and soft curves that invite you to sit down. The mind traces the mythical 60s, while the woodworking speaks of sophisticated contemporaneity. Agave is a collection that invites to a relaxed and elegant conviviality.

Technical info pp.252

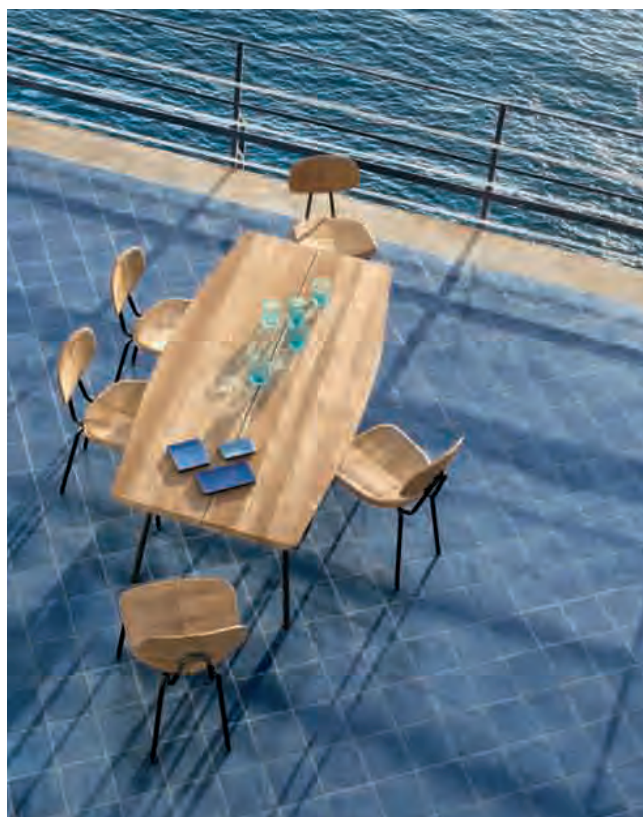
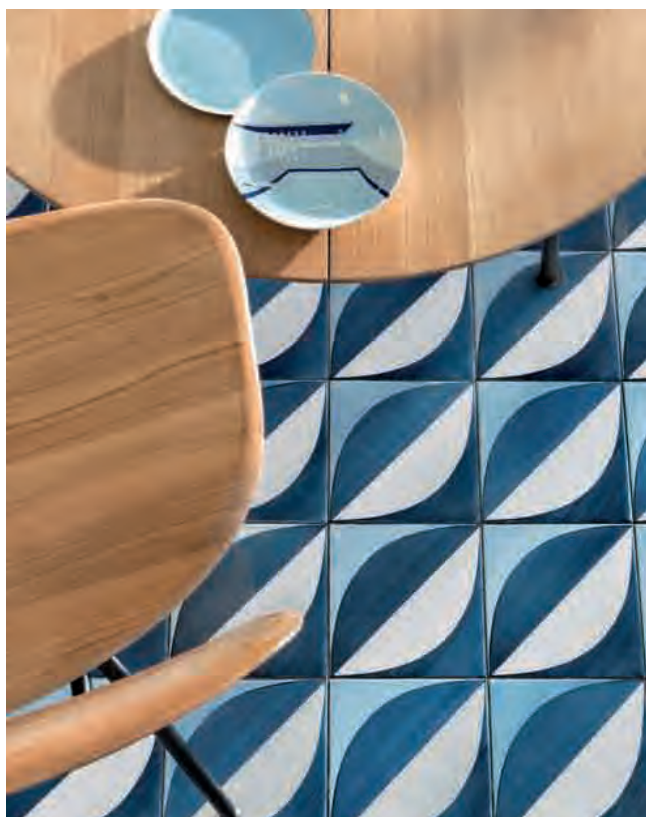



# Agave

it / Le sinuose forme della pianta di agave si ritrovano nei profili di tavoli e sedie. Il teak crea soluzioni dining sofisticate e funzionali.

en / The sinuous shapes of the agave plant can be found in the profiles of tables and chairs. Teak creates sophisticated and functional dining solutions.

Technical info pp.252



Tavolino in teak naturale e metallo sepia black.  
/ Coffee table in natural teak and sepia black metal frame.











# Costes

Collection composed of: 3 seater sofa / modular sofa / lounge armchair / coffee table / dining armchair / round and rectangular dining table / sun lounger.

it / Una linea completa di arredi il cui fil rouge si snoda tra le molteplici capacità espressive del legno. I divani, i lettini, i dining set arredano spazi aperti in cui rilassarsi all'insegna del comfort e in continuità con la natura.

en / A complete line of furnishings whose fil rouge winds through the multiple expressive capabilities of wood. Sofas, loungers, dining sets furnish open spaces in which to relax in comfort and in continuity with nature.

Technical info pp.254

Salotto in teak naturale.  
Lettini prendisole in teak decapato.  
/ Lounge set in natural teak. Sun loungers in pickled teak.

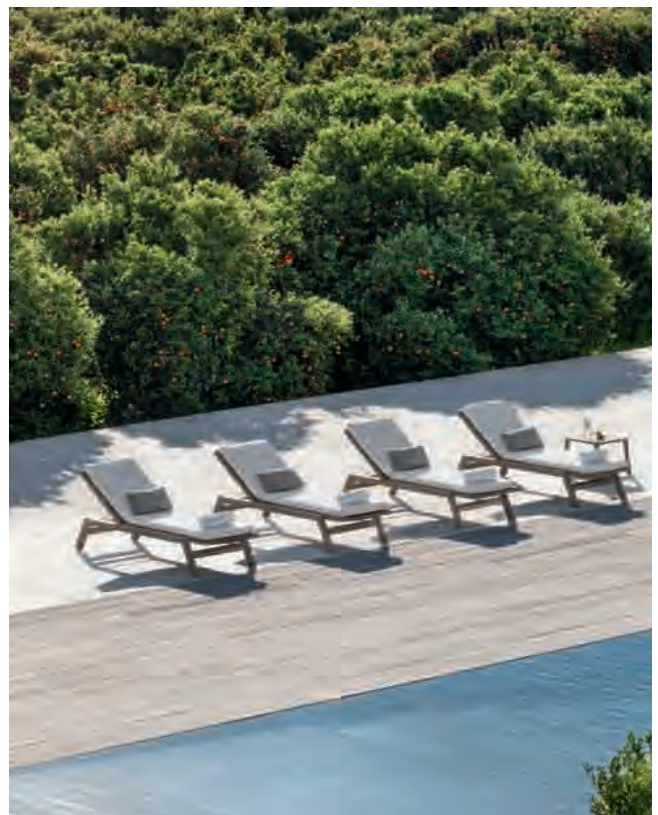



# Costes



Divano modulare  
in teak decapato e  
cuscini black stone.  
/ Modular sofa  
in pickled teak and  
black stone cushions.











# Costes

it / Rotondo con piano girevole o rettangolare, i tavoli della collezione Costes sono un'ode alla convivialità. Le ampie dimensioni ospitano fino dieci posti, per pranzi all'aperto in pieno comfort e a contatto con la natura.

en / Round with revolving top or rectangular, the tables from the Costes collection are an ode to conviviality. The large size accommodates up to ten seats, for outdoor dining in full comfort and in contact with nature.

Technical info pp.254









# Play

Collection composed of: square dining table / xl square dining table / rectangular dining table / xl rectangular dining table / ping pong table.

it / La collezione Play è una proposta completa di tavoli in alluminio con dimensioni diverse e piani realizzati in differenti materiali. L'intera linea soddisfa esigenze sia residenziali che contract.

en / The Play collection is a complete proposal of aluminium tables with different sizes and tops made of several materials. The entire line meets both residential and contract needs.

Technical info pp.256

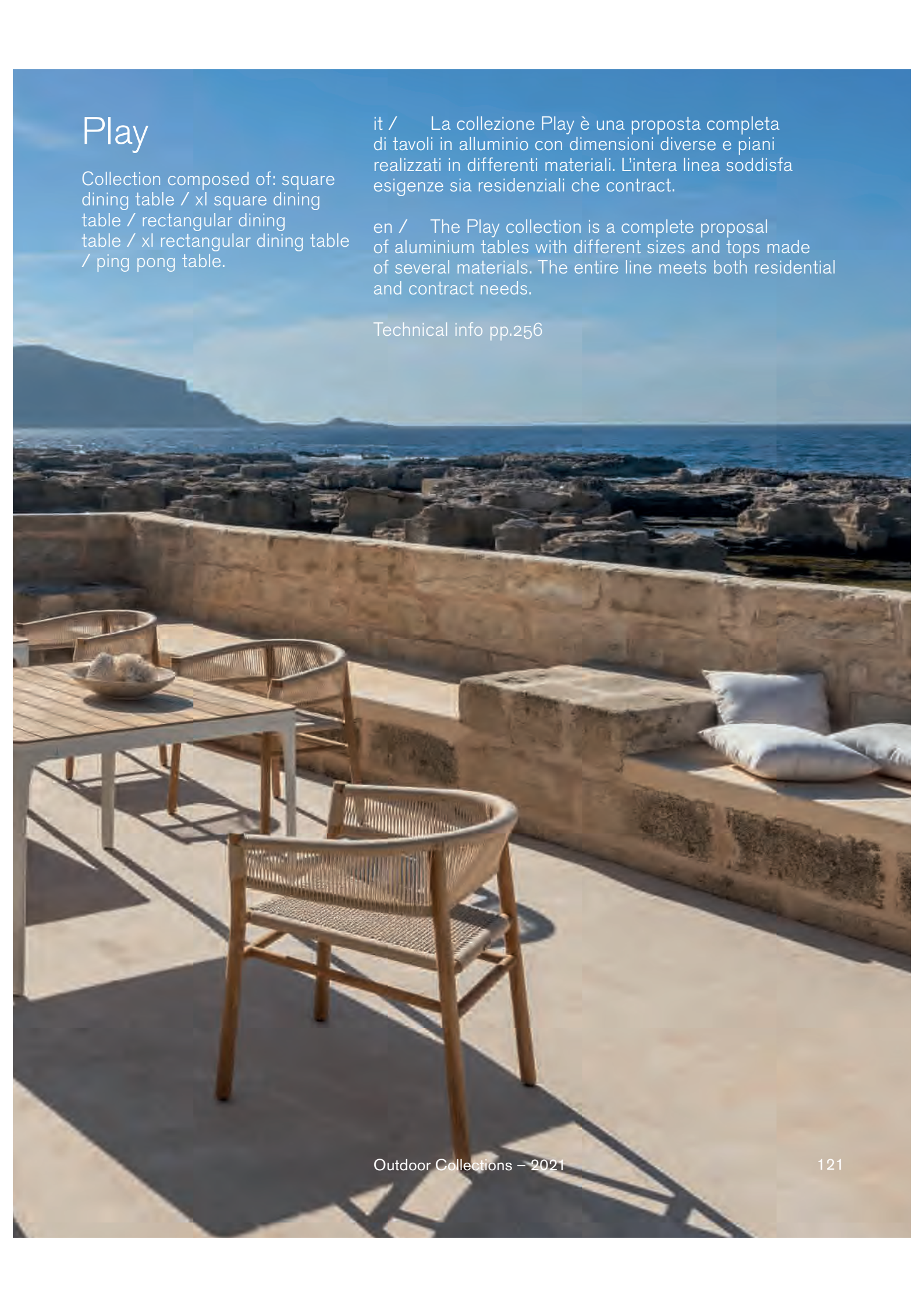





Dettaglio del top in  
ceramica ice stone e  
piombo silk.  
/ Detail of top in ice white  
and piombo silk ceramic  
stone.

Tavolo 149x149 cm  
con top Disegno in  
ceramica a tre colori.  
/ Table 149x149 cm  
with Disegno top in  
three colours.

Tavolo XL con piano in  
teak naturale. Poltroncine  
Kilt in acciaio.  
/ XL Table with natural  
teak top.  
Kilt armchairs in stainless  
steel.



Play









# Nicolette

Collection composed of:  
dining armchair / barstool.

# Patrick Norguet

it / In alluminio pressofuso e dalle forme avvolgenti, Nicolette abbina tecnologia e design, creando una seduta robusta e sofisticata pensata per spazi all'aria aperta e per eleganti ambienti indoor.

en / In die-cast aluminium and with enveloping shapes, Nicolette combines technology and design, creating a robust and sophisticated seat created for outdoor spaces and elegant indoor environments.

Technical info pp.260





# Enjoy

Collection composed of: dining table / lounge dining table / high table / coffee table.

it / Enjoy è una collezione di tavoli disponibili in cinque altezze, con piani in ceramica dalle linee smussate, che differiscono per dimensione e colore.

en / Enjoy is a collection of tables available in five heights, with ceramic tops with rounded lines, which differ in size and color.

Technical info pp.258



Tavoli in metallo con piano in pietra ceramica e base opzionale in teak.  
/ Tables with metal frames, ceramic stone tops and optional teak base.











# Flat / Studios

Collection composed of:  
Flat – rectangular extendable table.

Studios – director folding armchair.

it / Il tavolo Flat in metallo, estensibile fino a 360 cm, si abbina alla poltroncina Studios, creando un dining set dal carattere contemporaneo.

en / The Flat metal table, extendable up to 360 cm, matches the Studios armchair, creating a dining set with a contemporary character.

Technical info pp.261





# Infinity

Collection composed of:  
3 seater sofa / modular sofa  
/ lounge armchair / daybed  
/ pouf / coffee table  
/ sun lounger.

it / La collezione Infinity prende il nome dalla componibilità illimitata dei suoi elementi: un sistema versatile e accogliente di sedute lounge.

en / The Infinity collection takes its name from the unlimited modularity of its elements: a versatile and welcoming system of lounge seats.

Technical info pp.262



Divano modulare  
in alluminio warmwhite,  
fibra Lightwick e tavolino.  
/ Modular sofa  
in warmwhite aluminium,  
Lightwick fiber  
and coffee table.











# Infinity

it / Una collezione lounge in cui la fibra intrecciata incontra il metallo, creando comodi lettini e sofisticati salotti modulari. Lo spazio esterno è un luogo speciale da vivere e ridisegnare in base alle proprie esigenze.

en / A lounge collection in which woven fiber meets metal, creating comfortable sun beds and sophisticated modular lounge sets. The outdoor space is a special place to live and redesign according to your needs.

Technical info pp.262

Lettini disponibili in alluminio e fibra Lightwick o in alluminio e tessuto tecnico Ethitex. Tavolino d'appoggio Smart.  
/ Sun loungers available in aluminium and Lightwick fiber or in aluminium and Ethitex technical fabric. Smart side table.





# Ocean

Collection composed of:  
sun lounger.

it / Essenziale e sofisticata, la struttura in metallo dei lettini Ocean assume forme morbide come le onde del mare. L'impilabilità di ciascun elemento sottolinea la funzionalità della collezione.

en / Essential and sophisticated, the metal structure of the Ocean sun loungers takes on soft shapes like the waves of the sea. The stackability of each element emphasizes the functionality of the collection.

Technical info pp.264

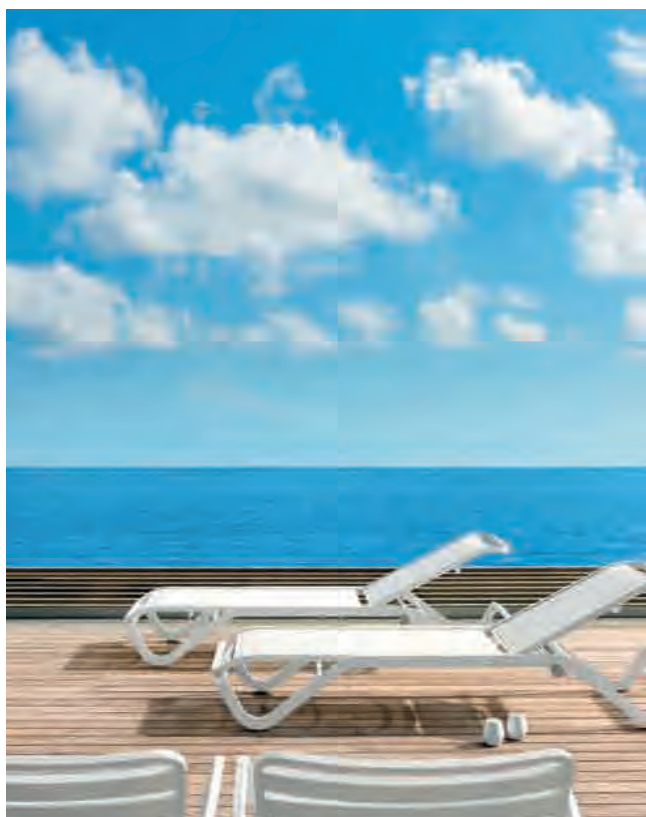

Lettini in alluminio  
e tessuto Ethitex.  
Tavolino Smart.  
/ Sun loungers  
in aluminium and Ethitex  
fabric. Smart side table.







# Essenza

Collection composed of: sun lounger  
/ double canopy sun lounger.

it / — Essenza è un'alcova dalle proporzioni generose ed accoglienti, in cui il teak racchiude sottili profili in acciaio spazzolato. L'equilibrato gioco materico crea un'idea di continuità tra design e benessere.

en / — Essenza is an alcove with generous and welcoming proportions, in which teak contains thin brushed steel profiles. The balanced play of materials creates an idea of continuity between design and well-being.

Technical info pp.265













# Cronos

Collection composed of: round dining table / square dining table / rectangular extendable dining table.

it / Realizzati in teak naturale o decapato, la collezione dei tavoli Cronos richiama la tradizione artigianale del legno. La base, che sorregge i piani, crea geometrie e simmetrie dallo stile classico contemporaneo.

en / Made of natural or pickled teak, the Cronos tables collection recalls the artisan tradition of wood. The base, which supports the tops, creates geometries and symmetries with a classic contemporary style.

Technical info pp.266





# Friends

Collection composed of: square dining table / rectangular dining table.

it / Una linea di tavoli dai profili essenziali, in cui il calore del legno di teak è protagonista. Disponibili in due dimensioni, i tavoli Friends raccontano un'idea di convivialità semplice e raffinata.

en / A line of tables with essential profiles, in which the warmth of teak wood is the protagonist. Available in two different sizes, the Friends tables narrate an idea of simple and refined conviviality.

Technical info pp.265













# Elle / Elit / Clay

Collection composed of:  
Elle – Deck chair.

Elit – Sunbed.

Clay – Coffee table.

it / Minimalisti nei profili e nel design, la sdraio Elle e il lettino Elit abbinano il legno di teak della struttura alle diverse cromie di teli in Ethitex o tessuto acrilico. Veri *must have* dell'outdoor.

en / Minimalist in profiles and design, the Elle deck chair and the Elit sunbed combine the teak wood of the structure with the different colors of the Ethitex or acrylic fabric cloths. True outdoor must haves.

Technical info pp.267





# Cruise / Notting Hill

Collection composed of:  
Cruise – Deck chair.

Notting Hill – bench / armchair.

it / Classici irrinunciabili dell'arredo per esterno, la chaise-longue Cruise e la panca Notting Hill hanno un fascino vintage che rivive nel design e nei dettagli.

en / Indispensable classics of outdoor furniture, the Cruise chaise-longue and the Notting Hill bench have a vintage charm that lives on in the design and details.

Technical info pp.271



Chaise longue in teak naturale e panca in mogano Langhe green.  
/ Chaise longue in natural teak and bench in Langhe green mahogany.







# Sand / Sandy

Collection composed of:  
Sand – sunbeds.

Sandy – backrest with mattress.

it / Il legno di teak compone i profili razionali del lettino Sand. Il pratico schienale regolabile conferisce leggerezza alla struttura, accentuandone il comfort.

en / Teak wood makes up the rational profiles of the Sand sunbed. The practical adjustable backrest gives lightness to the structure, accentuating its comfort.

Technical info pp.269









# Sand / Sandy

it / Sandy è un'idea di relax a contatto con la natura. Lo schienale regolabile si abbina al morbido materassino in un mix di estetica lineare e funzionalità.

en / Sandy is an idea of relaxation in contact with nature. The adjustable backrest matches the soft mattress in a mix of linear aesthetics and functionality.

Technical info pp.26g



Lettini in teak e tessuto  
Ethitex white o dove grey.  
Tavolino Clay.  
/ Sun loungers in teak and  
Ethitex white or dove grey.  
Clay coffee table.











# Elisir

Collection composed of: 2 seater sofa / lounge armchair / coffee table / dining armchair / dining chair / round, square and rectangular extendable dining table / sunbed.

it / Sfoggia uno stile inossidabile questa collezione di arredi in metallo ispirati alle linee classiche, ma pronta a soddisfare tutte le esigenze dell'outdoor contemporaneo.

en / This collection of metal furniture inspired by classic lines shows a timeless style, but ready to meet all the needs of the contemporary outdoors.

Technical info pp.272





# Elisir

it / I tavoli e le sedute dining incontrano il paesaggio naturale e si armonizzano con esso. I lettini abbinano il loro stile classico ai performanti teli in Ethitex, che caratterizzano la leggerezza del design.

en / The tables and dining chairs meet the natural landscape and harmonize with it. The sunbeds combine their classic style with high-performance Ethitex cloths, which characterize the lightness of the design.

Technical info pp.272













# Elisir

it / Il bianco abbagliante di un'architettura mediterranea accoglie i profili classici del salotto Elisir. Il tavolo da pranzo allungabile, in metallo mud grey, e le poltroncine dining si inseriscono nel paesaggio circostante, in una contrastante e armoniosa alternanza cromatica.

en / The dazzling white of Mediterranean architecture welcomes the classic profiles of the Elisir living room. The extendable dining table, in mud grey metal, and the dining armchairs fit into the surrounding landscape, in a contrasting and harmonious chromatic alternation.

Technical info pp.272



Salotto in metallo white.  
Cuscini nature grey.  
/ Lounge set in white  
metal frame. Nature grey  
cushions.



# Laren

Collection composed of: folding chair / stacking chair / stacking armchair / round, square and rectangular dining table / high table / barstool.

it / Le linee essenziali della collezione Laren sono esaltate dall'incontro materico tra il metallo e il teak. Una linea che con armonia racconta una convivialità dallo stile discreto e raffinato.

en / The essential lines of the Laren collection are enhanced by the material encounter between metal and teak. A collection that harmoniously tells a conviviality with a discreet and refined style.

Technical info pp.274













Laren









# Laren

it / I ricercati dettagli che caratterizzano i tavoli, le sedie e gli sgabelli bistrot, rendono la collezione Laren perfetta in un giardino residenziale così come in ambienti outdoor dal carattere contemporaneo e minimale.

en / Refined details that characterize the tables, chairs and bistro stools make the Laren collection perfect in a residential garden as well as in outdoor environments with a contemporary and minimal character.

Technical info pp.274









# Flower

Collection composed of: folding chair / stacking chair / stacking armchair / round, square and rectangular dining table / high table / barstool.

it / La collezione Flower è una linea di tavoli e sedie in cui il metallo colorato percorre le vivaci cromie della natura. Tredici diverse nuance di colore per lasciare spazio alla creatività.

en / The Flower collection is a line of tables and chairs in which colored metal runs through the bright colors of nature. Thirteen different shades of color to leave room for creativity.

Technical info pp.276









# Flower

fr / La nuova colorazione Peacock si aggiunge all'ampia palette cromatica che caratterizza l'intera collezione. Una nuance brillante e raffinata che dà stile e personalità a giardini e terrazze contemporanei.

de / The new Peacock color is added to the wide color palette that characterizes the entire collection. A brilliant and refined nuance that gives style and personality to contemporary gardens and terraces.

Technical info pp.276









# Phorma / Loto

Collection composed of:  
Phorma – 3 seater sofa  
/ lounge armchair.

Loto – coffee table.

it / Il salotto Phorma ha un design morbido ed avvolgente. I cuscini, che vestono il divano a tre posti e le poltrone lounge, accolgono il corpo nel massimo del comfort e del relax.

en / The Phorma lounge set has a soft and enveloping design. The cushions, which dress the three-seater sofa and lounge armchairs, welcome the body in maximum comfort and relaxation.

Technical info pp.280



# Cube

Collection composed of: 3 seater sofa / modular sofa / lounge armchair / pouf / coffee table / double and single sunbed / footstool.

it / I volumi geometrici della collezione Cube prendono forma attraverso la matericità della fibra Etwick, intrecciata a mano. Una proposta completa di arredi lounge dedicati al relax per creare infinite composizioni nel segno della modularità.

en / Geometric volumes of the Cube collection take shape through the materiality of the hand-woven Etwick fiber. A complete range of lounge furniture dedicated to relaxation to create infinite compositions in the name of modularity.

Technical info pp.278













# Cube

it / Disponibile in fibra bianca o corteccia, la collezione Cube è la soluzione ideale sia per progetti residenziali che contract.

en / Available in white or bark fiber, the Cube collection is the ideal solution for both residential and contract projects.

Technical info pp.278





# Holiday

Collection composed of: square and rectangular wooden umbrella.

Technical info pp.281



Ombrellone con palo in legno e telo dove grey.  
/ Umbrella with wooden pole and dove grey fabric.



# Freedom

Collection composed of: square adjustable aluminium umbrella.

Technical info pp.284









# Classic

Collection composed of: square, round and rectangular wooden umbrella.

Technical info pp.282





# Free

Collection composed of: square and rectangular aluminium umbrella.

Technical info pp.285



Ombrelloni con palo in alluminio e tessuto white e red.  
/ Umbrellas with aluminium pole and white and red fabric.











# Clostra

Collection composed of: high shield / low shield / planter.

# Emmanuel Gallina

it / La schermatura Clostra nasce dall'incontro tra il teak e l'alluminio: le doghe in legno si legano al metallo, alternandosi su due livelli e creando un interessante gioco di profondità. La base può essere completata da una fioriera per dar vita a pareti verdi o fiorite.

en / Clostra shielding arises from the encounter between teak and aluminium: the wooden slats are bonded to the metal, alternating on two levels and creating an interesting play of depth. The base can be completed with a planter to create green or flowered walls.

Technical info pp.286









# Rug Collection

Collection composed of: rug  
Malindi / Goa / Petra / Coimbra.

it / Una collezione di tappeti, intrecciati a mano e ispirati ai colori della natura mediterranea, che completano aree dining e zone lounge all'aria aperta. La fibra rievoca materiali naturali mantenendo le specificità richieste dall'utilizzo in outdoor.

en / A collection of hand-woven rugs inspired by the colors of Mediterranean nature, that complete the dining areas and open-air lounge spaces. The fiber evokes natural materials while maintaining the specificities required for outdoor use.

Technical info pp.287





# Lucerna

Collection composed of:  
rechargeable lantern / wired  
lantern / wall lantern.

# Luca Nichetto

it / Ispirata alle antiche lanterne romane, Lucerna  
abbina l'utilizzo della luce a Led al prezioso diffusore  
in vetro soffiato trasparente o acidato.  
Un oggetto dal design sofisticato che emana una calda  
ed intima luminosità.

en / Inspired by ancient Roman oil lamps, Lucerna  
combines the use of Led light with the precious diffuser  
in transparent or etched blown glass.  
An object with a sophisticated design that spreads a warm  
and intimate glow.

Technical info pp.288



Lampada a led ricaricabile  
con corpo illuminante  
in alluminio e vetro  
soffiato.  
/ Rechargeable led  
lantern with aluminium  
illuminating body  
and blown glass.







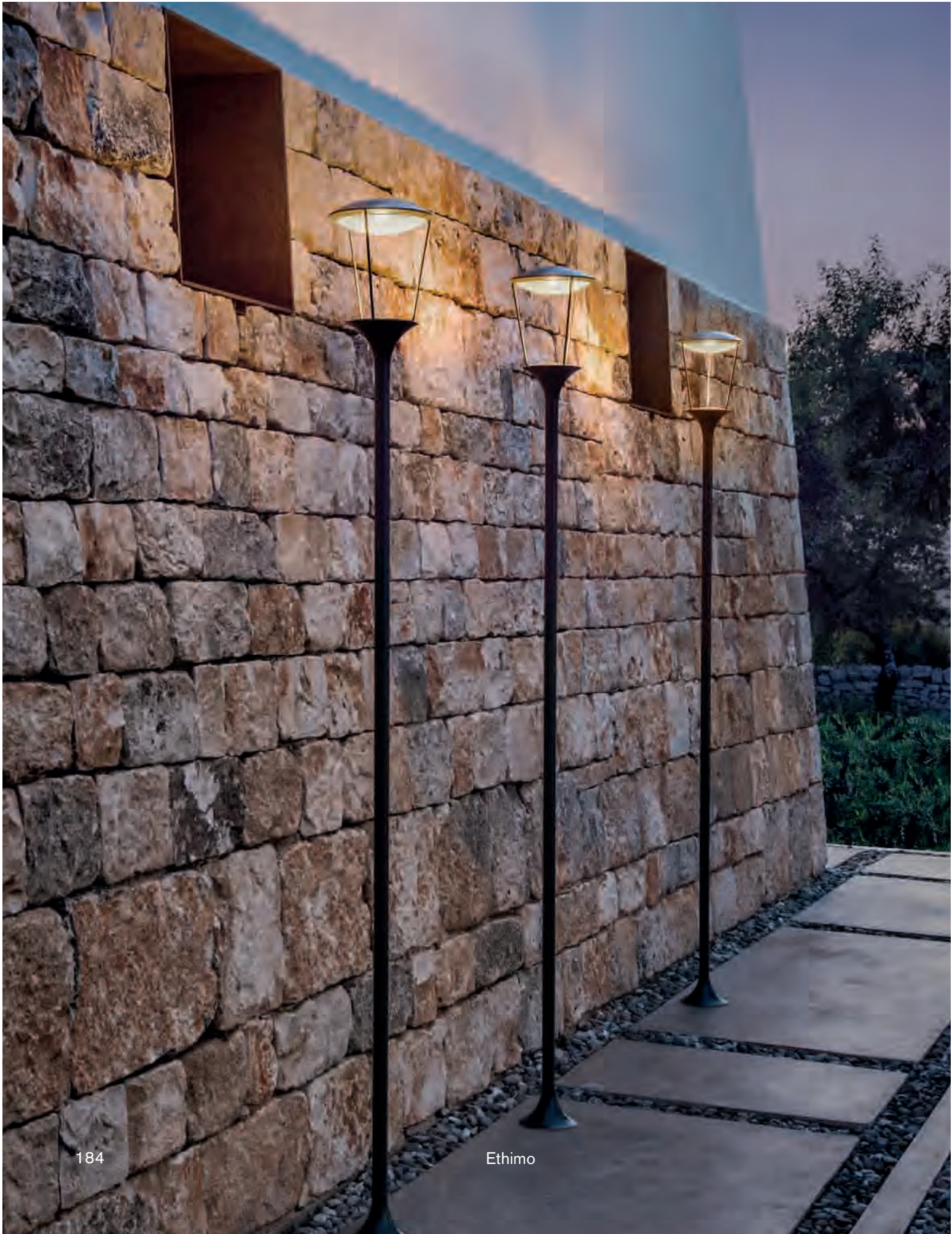



# Pharos

Collection composed of: lamp post / wall lamp post.

# Luca Nichetto

it / Rievocando nel design l'ottocentesca illuminazione urbana, Pharos ha una sorgente luminosa a Led. La sua illuminazione riflessa dall'alto crea una luce diffusa ed accogliente, caratterizzando con stile i più sofisticati spazi outdoor.

en / Reminiscent in design of nineteenth-century street lamps, Pharos has a led light source. Its glow reflecting from above creates a diffused and cosy light, featuring in style the most sophisticated outdoor spaces.

Technical info pp.289









## Milk / Shake

Collection composed of:  
Milk – Portable solar lamp.

Shake – floor lamp  
/ xl floor lamp.

## Emmanuel Gallina

it/ Milk è una lanterna dallo spirito 'nomade', realizzata in vetro sabbato, teak e cuoio, che rievoca nel design i tradizionali contenitori del latte. La luce si diffonde dolcemente, utilizzando l'energia pulita del sole.

Shake è una lampada da terra, dallo stile minimale e caratterizzata da raffinati dettagli in teak.

en / Milk is a lamp with a 'nomadic' spirit, made of sandblasted glass, teak and leather, which evokes the traditional design of milk containers. The light diffuses gently, using the clean energy of the sun.

Shake is a floor lamp, with a minimal style and characterized by refined teak details.

Technical info pp.290









## Carré

Collection composed of:  
wall lamp / table lamp  
/ rechargeable table lamp  
/ bollard / xl floor lamp.

## Niccolò Grassi

it / Il legno e il metallo si uniscono per creare una lanterna, disponibile in più dimensioni, che si ispira ai classici del XX secolo. Il Led la rende efficiente ed eco-sostenibile.

en / Wood and metal come together to create a lamp, available in several sizes, inspired by 20th-century classics. The Led makes it efficient and eco-sustainable.

Technical info pp.292



Lampade in teak decapato e metallo con tecnologia a Led.  
Tavolino Petit club.  
/ Lamps in pickled teak and metal with Led technology. Petit club coffee table.







## Ginger / Step

Collection composed of:  
Ginger – wall lamp / wired  
table lamp / xl floor lamp.

Step – path lamp.

## Niccolò Grassi

it / Un inaspettato gioco di luci è creato dalle lamelle in teak che caratterizzano la collezione Ginger. La luce sembra proiettarsi nello spazio con la stessa intensità del sole che attraversa le persiane nei pomeriggi d'estate.

Step è una lampada segnapasso in terracotta toscana.

en / An unexpected play of light is created by the teak slats that characterize the Ginger collection. The light seems to project itself into space with the same intensity as the sun passing through the shutters on summer afternoons.

Step is a path lamp in Tuscan terracotta.

Technical info pp.291–293









Ethimo.  
I padiglioni. The pavilions.  
Les pavillons. Die Pavillons.







# Eivissa

Collection composed of:  
Open Air pavilion / Climate  
pavilion / Light & Proof pavilion.

# Ludovica + Roberto Palomba

it / I padiglioni Eivissa sono moduli abitativi che si inseriscono nel paesaggio naturale come architetture contemporanee. La solida struttura in alluminio crea stanze a cielo aperto performanti e confortevoli.

en / The Eivissa pavilions are living modules that fit into the natural landscape like contemporary architecture. The solid aluminium structure creates high-performance and comfortable open-air rooms.

Technical info  
[www.ethimo.com](http://www.ethimo.com)



Eivissa Climate  
con copertura a  
lamelle orientabili  
e tende decorative.  
/ Eivissa Climate  
with adjustable slats  
cover and decorative  
curtains.



Eivissa





it / Padiglione bioclimatico con soffitto a lamelle orientabili, pavimento in teak, pannelli scorrevoli perimetrali in vetro e tende decorative.

en / Bioclimatic pavilion with adjustable louvered ceiling, teak floor, perimeter sliding glass panels and decorative curtains.

Technical info  
[www.ethimo.com](http://www.ethimo.com)





Eivissa

## Ludovica + Roberto Palomba

it / Padiglione, versione Open Air con copertura in lamelle fisse di teak e tenda scorrevole Flow. Tende perimetrali in tessuto acrilico.

en / Pavilion, open Air version with fixed teak slat roof and Flow sliding curtain. Perimeter curtains in acrylic fabric.

Technical info  
[www.ethimo.com](http://www.ethimo.com)



Copertura con lamelle  
fisse di teak decapato.  
/ Cover with fixed pickled  
teak slats.



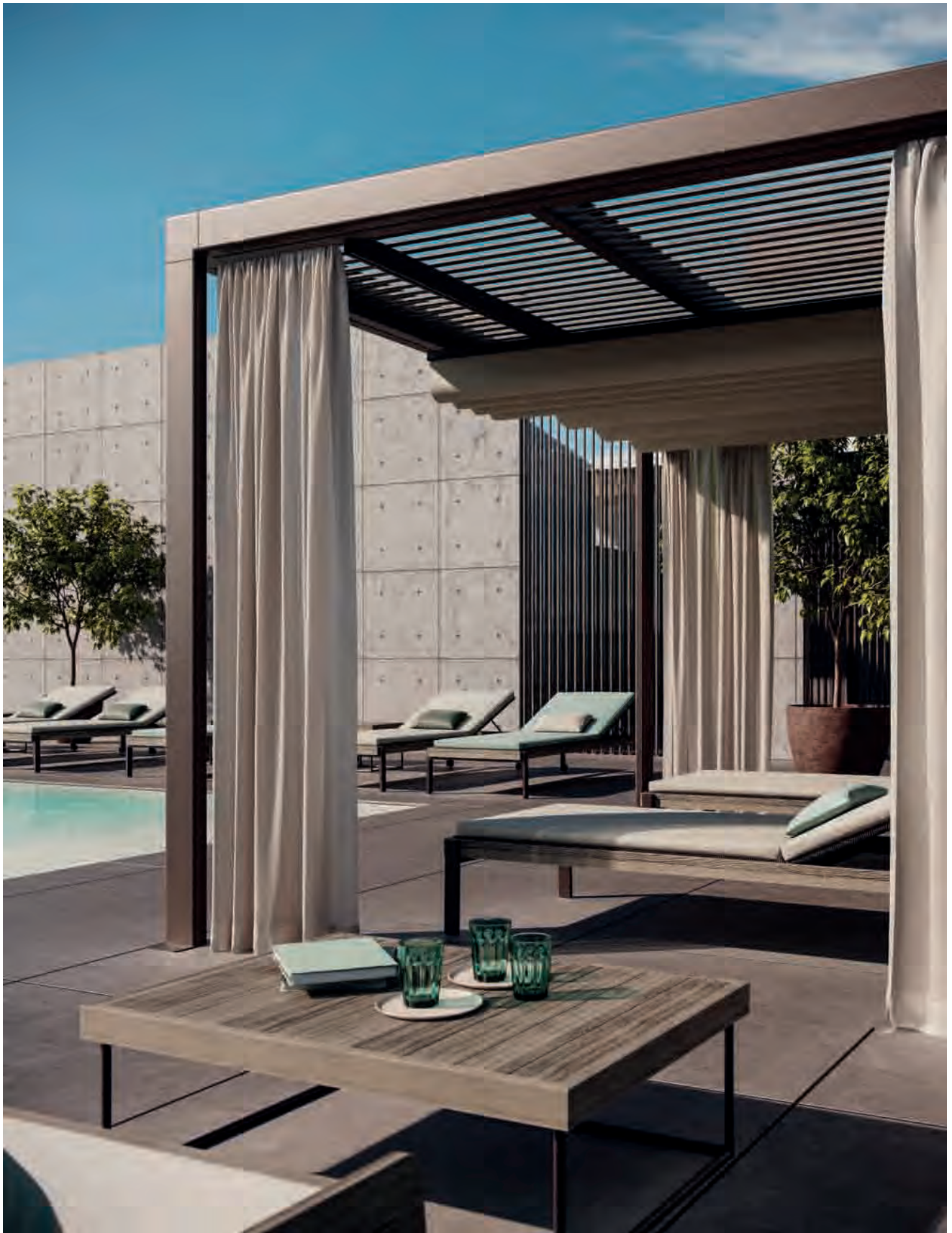







Ethimo.  
Materiali. Materials.  
Matériaux. Materialien.



# Materiali

it / Ethimo pone grande attenzione alla scelta dei materiali, al progetto, alle lavorazioni, ai servizi. La certificazione ISO 9001 garantisce la completa efficienza del sistema aziendale.

## Teak

Il teak utilizzato per la realizzazione delle collezioni Ethimo è di primissima qualità e certificato FSC (Forest Stewardship Council). Proviene esclusivamente da piantagioni a ricrescita controllata nel rispetto dei rigidi processi di riforestazione e da una filiera di approvvigionamento gestita in modo responsabile, nel rispetto di regole condivise in tutto il mondo. È un materiale eccellente per la realizzazione di mobili per esterno perché estremamente resistente ai cambiamenti di temperatura, all'acqua, all'umidità, alla salsedine. Ethimo utilizza teak naturale, teak naturale spazzolato, teak trattato con finitura decapata che apporta al legno una patina grigia, un aspetto vissuto.

## Mogano verniciato

Per gli elementi di arredo in legno verniciato, Ethimo ha scelto il mogano proveniente da piantagioni regolamentate. Il mogano è un legno molto resistente e adatto all'uso all'esterno, utilizzato comunemente anche per la costruzione delle imbarcazioni. Dopo l'essiccazione e prima della verniciatura, il legno viene trattato con un prodotto sigillante che chiude i pori rendendolo impermeabile. Le vernici utilizzate sono resistenti agli agenti atmosferici e alle intemperie, garantite da una speciale procedura per il fissaggio del colore.

## Accoya®

L'Accoya® è una nuova varietà di legname di eccezionale durabilità, ottenuta mediante un processo atossico di acetilazione, con prestazioni che lo rendono ideale per applicazioni esterne. Viene prodotto con materie prime sostenibili ed è inoltre dotato di una stabilità dimensionale e di una durabilità in grado di superare quella dei migliori legni duri tropicali.

## Corde

Le corde impiegate nelle collezioni Ethimo sono specifiche per l'utilizzo all'esterno, realizzate in materiale sintetico estremamente resistente ai raggi UV, all'abrasione e agli eventi atmosferici. Differenti per sezione e colore, le corde sono utilizzate per creare sedute e schienali intrecciati, estremamente funzionali e confortevoli.

## Fibre

La fibra è un materiale sintetico riciclabile che garantisce estrema resistenza agli agenti atmosferici e all'usura. Le varianti di fibra impiegata per le collezioni Ethimo sono intrecciate a mano ed hanno sezione di diversa misura e finitura. Queste caratteristiche specifiche consentono di ottenere pattern diversi e dinamici, che conferiscono naturalezza e leggerezza all'intreccio.

## Rattan naturale

Il rattan è una fibra naturale che proviene dal fusto di una palma. Flessibile e malleabile, può essere lavorato e intrecciato facilmente per dar forma a vari oggetti.

Materiale tipico degli arredi outdoor degli anni '50, in realtà è piuttosto delicato e deve essere trattato con accortezza nell'uso all'esterno, protetto dalle intemperie e dall'attacco degli agenti atmosferici. Se ne consiglia l'uso in ambienti coperti.

## Pietra ceramica

La ceramica è un materiale ideale per l'utilizzo all'esterno perché estremamente resistente al gelo, all'usura, a graffi e abrasioni. Le sue proprietà antibatteriche la rendono perfettamente compatibile con le sostanze alimentari, rendendola adatta per realizzare top e piani per tavoli.

## Pietre

Ethimo utilizza per i propri complementi di arredo alcune pietre naturali come il marmo statuario e la pietra lavica. Il marmo è sottoposto ad un trattamento protettivo che conferisce alla superficie una finitura opaca. La pietra lavica è smaltata a caldo con un procedimento artigianale che rende ogni pezzo unico nelle sue sfumature. In ogni caso, i trattamenti superficiali effettuati rendono tali pietre resistenti agli agenti atmosferici, alle macchie, al graffio e perfettamente adatte all'uso all'esterno.

## Metallo

Nella categoria "metallo" rientrano il comune acciaio, l'acciaio inox e l'alluminio utilizzati normalmente nella produzione di arredi outdoor. L'acciaio presenta proprietà che variano in base alla composizione chimica (quantità di carbonio e quantità di altri elementi leganti), ai trattamenti termoindurenti e al processo di produzione. Per garantire la resistenza alla ruggine, l'acciaio Ethimo è sottoposto ad un complesso trattamento di protezione alla corrosione. Per la verniciatura sia dell'acciaio che dell'alluminio vengono utilizzate polveri epossidiche termoindurenti arricchite con materiale antigraffio (Teflon). La resistenza ai raggi UV è garantita 10 anni.



# Materials

en / Ethimo is very careful in its choice of materials, design, production processes and services. ISO 9001 certification guarantees the total efficiency of the company's system.

## Teak

The teak used to make the Ethimo collections is prime quality and FSC (Forest Stewardship Council) certified. It comes exclusively from plantations with controlled regrowth that respect strict reforestation processes, part of a responsibly managed supply chain that respects regulations shared worldwide. It is an excellent material for the production of outdoor furniture as it is extremely resistant to changes in temperature, water, humidity and salt. Ethimo uses natural teak, brushed natural teak, and teak given a pickling treatment that gives the wood a grey, aged look.

## Painted mahogany

For its painted wood furnishings, Ethimo sources mahogany from controlled plantations. Mahogany is a highly resistant wood, suitable for use outdoors and regularly used also in boat building. After drying and before painting, the wood is treated with a sealant that closes its pores to make it waterproof. The paints used are resistant to the atmospheric agents and bad weather, guaranteed by a special procedure that fixes the colour.

## Accoya®

Accoya® is a highly durable new timber product obtained thanks to a non-toxic acetylation process, with qualities that make it ideal for outside purposes. It is produced from sustainable raw materials and has greater dimensional stability and durability than the best tropical hardwoods.

## Ropes

The ropes used in the Ethimo collections are specific for outdoor use and made from a synthetic material that is highly resistant to UV rays, abrasion and the elements. In different thicknesses and colours, the ropes are woven to make extremely functional and comfortable seats and backs.

## Fibres

Fibre is a recyclable synthetic material that guarantees extreme resistance to atmospheric agents and wear and tear. The variants of fibre used in the Ethimo collections are hand woven and have different thicknesses and finishes. These specific characteristics make it possible to create different dynamic patterns, lending naturalness and lightness to the weave.

## Natural rattan

Rattan is a natural fibre made from the stem of a certain kind of palm. Flexible and pliant, it is easy to work and weave into various objects. A typical material for outdoor furniture in the fifties, it is actually quite delicate and must be treated carefully when used outside, protected from bad weather and aggression by atmospheric agents. It is recommended for use in covered spaces.

## Ceramic stone

Ceramic is an ideal material for outdoor use, as it is extremely resistant to frost, wear, scratches and abrasion. Its anti-bacterial properties make it perfectly compatible with foodstuffs, and therefore ideal for counters and table tops.

## Stone

Ethimo uses natural stone, such as statuary marble and lava stone for its furnishing accessories. The marble is given a treatment to protect its surface that leaves it with a matte finish. Lava stone undergoes a vitreous enamel artisan procedure that gives each piece unique nuances. In each case, the surface glaze makes this stone resistant to atmospheric agents, stains and scratching, and therefore perfectly suitable for outdoor use.

## Metal

The "metal" category includes the common steel, stainless steel and aluminium normally used in the production of outdoor furnishings. The properties of steel vary according to its chemical composition (quantity of carbon and other alloys), heat hardening treatment and production processes. To guarantee rust resistance, Ethimo steel undergoes complex anti-corrosion treatment. Both steel and aluminium are coated with heat-cured epoxy powders enriched with an anti-scratch material (Teflon). UV-ray resistance is guaranteed for 10 years.



# Matériaux

fr / Ethimo accorde une grande attention au choix des matières, au projet, à la transformation, aux services. La certification ISO 9001 garantit l'efficacité totale du système de l'entreprise.

## Teck

Le teck utilisé pour réaliser les collections Ethimo est de la plus haute qualité et certifié FSC (Forest Stewardship Council). Il provient exclusivement de plantations à repousse contrôlée dans le respect de processus de reforestation stricts et d'une chaîne d'approvisionnement gérée de manière responsable, selon des règles partagées dans le monde entier. C'est un excellent matériau pour la fabrication de meubles d'extérieur car il est extrêmement résistant aux changements de température, à l'eau, à l'humidité, au sel. Ethimo utilise du teck naturel, du teck naturel brossé, du teck traité avec une finition décapée qui donne au bois une patine grise, un aspect vécu.

## Acajou verni

Pour les éléments de mobilier en bois vernis, Ethimo a choisi de l'acajou provenant de plantations réglementées. L'acajou est un bois très résistant et adapté à un usage extérieur, couramment utilisé aussi pour la construction de bateaux. Après le séchage et avant le vernissage, le bois est traité avec un produit d'étanchéité qui referme les pores et qui le rend imperméable. Les peintures utilisées sont résistantes aux agents atmosphériques et aux intempéries, et sont garanties par un procédé spécial de fixation de la couleur.

## Accoya®

L'Accoya® est une nouvelle variété de bois d'une durabilité exceptionnelle, qui est obtenue grâce à un procédé d'acétylation non toxique, et qui présente des performances qui la rendent idéale pour les applications extérieures. Il est produit à partir de matières premières durables et présente une stabilité dimensionnelle et une durabilité qui peuvent dépasser celles des meilleurs bois durs tropicaux.

## Cordes

Les cordes utilisées dans les collections Ethimo sont spécialement conçues pour l'extérieur, et réalisées dans une matière synthétique extrêmement résistante aux rayons UV, à l'abrasion et aux intempéries. Différentes en section et en couleur, les cordes servent à créer des assises et des dossiers tressés, extrêmement fonctionnels et confortables.

## Fibres

La fibre est une matière synthétique recyclable qui garantit une résistance extrême aux agents atmosphériques et à l'usure. Les variantes de fibres utilisées pour les collections Ethimo sont tressées à la main et présentent des sections de différentes tailles et finitions. Ces caractéristiques spécifiques permettent d'obtenir des motifs différents et dynamiques, qui apportent un caractère naturel et une légèreté au tissage.

## Rotin naturel

Le rotin est une fibre naturelle qui provient de la tige du palmier. Souple et malléable, il peut être travaillé et tressé facilement pour donner forme à des objets divers. Matériau typique du mobilier d'extérieur des années 50, il est en fait assez délicat et doit être traité avec soin lorsqu'il est utilisé au dehors, mis à l'abri des intempéries et des attaques climatiques. Il est recommandé de l'utiliser à l'intérieur.

## Pierre céramique

La céramique est une matière idéale en extérieur, car extrêmement résistante au gel, à l'usure, aux rayures et à l'abrasion. Ses propriétés antibactériennes la rendent parfaitement compatible avec les substances alimentaires, c'est pourquoi elle convient à la fabrication de plateaux et de dessus de table.

## Pierres

Ethimo utilise pour ses compléments d'ameublement des pierres naturelles telles que le marbre statuaire et la pierre de lave. Le marbre est soumis à un traitement de protection qui donne à la surface une finition mate. La pierre de lave est émaillée à chaud selon un procédé artisanal qui fait que chaque pièce est unique dans ses nuances. Dans tous les cas, les traitements de surface effectués rendent ces pierres résistantes aux agents atmosphériques, aux taches, aux rayures et parfaitement adaptées à un usage extérieur.

## Métal

La catégorie « métal » comprend l'acier ordinaire, l'acier inoxydable et l'aluminium normalement utilisés dans la production de mobilier d'extérieur. L'acier a des propriétés qui varient en fonction de sa composition chimique (quantité de carbone et quantité d'autres éléments d'alliage), des traitements thermodurcissables et du processus de production. Pour garantir la résistance à la rouille, l'acier Ethimo subit un traitement complexe de protection contre la corrosion. Des poudres époxy thermodurcissables enrichies d'un matériau anti-rayures (téflon) sont utilisées pour peindre aussi bien l'acier que l'aluminium. La résistance aux UV est garantie pendant 10 ans.



# Materialien

## Teakholz

Für die Kollektionen von Ethimo wird ausschließlich Teakholz höchster Qualität verwendet, das FSC (Forest Stewardship Council) zertifiziert ist. Es stammt ausschließlich aus Plantagen mit kontrolliertem Wiederaufbau unter Einhaltung strenger Wiederaufforstungsverfahren und aus einer verantwortungsbewusst geführten Lieferkette nach weltweit anerkannten Regeln. Teakholz eignet sich hervorragend für die Herstellung von Möbeln für den Außenbereich, da es extrem widerstandsfähig gegen Temperaturschwankungen, Wasser, Feuchtigkeit und Salz ist. Ethimo verwendet naturbelassenes und gebürstetes Teakholz sowie Teakholz mit gebeizter Oberfläche, die dem Holz eine graue Patina und damit ein „gelebtes“ Aussehen verleiht.

## Lackiertes Mahagoni

Für die lackierten Einrichtungselemente aus Holz verwendet Ethimo Mahagoni aus kontrollierten Plantagen. Mahagoni ist ein sehr widerstandsfähiges und für den Außenbereich geeignetes Holz, das auch häufig im Schiffsbau Verwendung findet. Nach dem Trocknen und vor dem Lackieren wird das Holz mit einem Versiegelungsprodukt behandelt, das die Poren verschließt und das Holz wasserdicht macht. Die verwendeten Lacke sind wetterfest und garantieren durch eine Spezialbehandlung die Beständigkeit der Farbe.

## Accoya®

Accoya® ist eine neue Holzsorte mit außergewöhnlicher Strapazierfähigkeit, die durch einen ungiftigen Acetylierungsprozess erzeugt wird. Ihre hervorragenden Eigenschaften machen sie ideal für Anwendungen im Außenbereich. Sie wird aus nachwachsenden Rohstoffen hergestellt und weist eine Formbeständigkeit und Haltbarkeit auf, die die der besten tropischen Harthölzer übertrifft.

## Schnüre

Die für die Kollektionen von Ethimo verwendeten Schnüre sind speziell für den Einsatz im Freien bestimmt. Sie bestehen aus synthetischem Material, das extrem widerstandsfähig gegen UV-Strahlen, Abrieb und Witterungseinflüsse ist. Die in Querschnitt und Farbe unterschiedlichen Schnüre werden zur Herstellung von geflochtenen Sitzen und Rückenlehnen verwendet, die äußerst funktionell und komfortabel sind.

## Fasergewebe

Das Fasergewebe von Ethimo ist ein recyclebares und gegen Witterungseinflüsse und Abnutzung extrem widerstandsfähiges synthetisches Material. Die für die Kollektionen von Ethimo verwendeten Faservarianten sind handgewebt und haben Querschnitte in verschiedenen Größen und Ausführungen. Dank dieser spezifischen Eigenschaften lassen sich unterschiedliche und dynamische Muster erzielen, die dem Gewebe Natürlichkeit und Leichtigkeit verleihen.

de / Ethimo widmet der Wahl der Materialien, dem Projekt, der Verarbeitung und den Dienstleistungen große Aufmerksamkeit. Die ISO 9001-Zertifizierung garantiert ein uneingeschränkt effizientes Unternehmenssystem.

## Natur-Rattan

Rattan ist eine Naturfaser, die aus dem Stamm einer Palme gewonnen wird. Sie ist flexibel und formbar und kann leicht bearbeitet und gewebt werden, um verschiedensten Objekten Form zu geben. Dieses für die Außenmöbel der 50er-Jahre typische Material ist ziemlich empfindlich und muss bei der Verwendung im Freien vorsichtig behandelt und vor Witterung und Witterungseinflüssen geschützt werden. Wir empfehlen eine Verwendung in überdachten Bereichen.

## Keramisches Gestein

Aufgrund seiner extremen Frost-, Verschleiß-, Kratz- und Abriebfestigkeit ist die Keramik ein ideales Material für den Außenbereich. Aufgrund seiner antibakteriellen Eigenschaften kann es problemlos mit Lebensmitteln in Berührung kommen, weshalb es sich zur Herstellung von Platten und Tischplatten eignet.

## Naturstein

Ethimo verwendet für seine Einrichtungsgegenstände einige Natursteine wie statuarischen Marmor und Lavastein. Der Marmor wird einer Schutzbehandlung unterzogen, wodurch die Oberfläche ein mattes Finish erhält. Der Lavastein wird in einem handwerklichen Verfahren heiß glasiert, wodurch jedes Stück in seinen Nuancen einzigartig wird. Diese Oberflächenbehandlungen machen diese Natursteine in jedem Fall widerstandsfähig gegen Witterungseinflüsse, Flecken und Kratzer. Damit eignen sie sich perfekt für den Einsatz im Freien.

## Metall

Zu der Kategorie „Metall“ gehören der gewöhnliche Stahl, rostfreier Stahl und Aluminium, die normalerweise bei der Herstellung von Außenmöbeln verwendet werden. Die Eigenschaften von Stahl hängen von der chemischen Zusammensetzung (Menge an Kohlenstoff und Menge an anderen bindenden Elementen), der Duroplastbehandlung und dem Herstellungsverfahren ab. Um die Rostbeständigkeit zu gewährleisten, wird der von Ethimo verwendete Stahl einer umfassenden Korrosionsschutzbehandlung unterzogen. Für die Lackierung von Stahl und Aluminium werden wärmehärtende Epoxidpulver angereichert mit einem kratzfesten Material (Teflon) verwendet. Die UV-Beständigkeit wird für zehn Jahre garantiert.









Collezione Knit,  
poltrone in teak e flat rope  
con cuscini Black & White  
Chess.  
/ Knit Collection,  
armchairs in teak and flat  
rope with Black & White  
Chess cushions.

Collezione Swing, pouf  
in diverse dimensioni e  
altezze, in teak e alluminio.  
/ Swing Collection, poufs  
available in different sizes  
and heights, in teak  
and aluminium.

Collezione Rafael,  
dettaglio intreccio corda  
flat rope light grey.  
/ Rafael collection,  
weaving light grey flat  
rope detail.



# Materiali. Materials. Matériaux. Materialien.

---

## Teak / Teak / Teck / Teak



T1 / Teak



T1S / Brushed  
Teak



T5 / Pickled  
Teak

## Accoya®

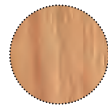

T1A / Accoya

---

## Mogano verniciato / Painted mahogany / Acajou peint / Lackiertes Mahagoni



M2 / Pantelleria  
Blue



M4 / Langhe  
Green



M3 / Ostuni  
White



M6 / Lipari  
Grey

---

## Corde / Ropes / Cordes / Seile



R70 / Flat Rope  
Lava Grey



R71 / Flat Rope  
Light Grey

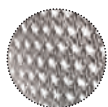

R1 / Round  
Rope Light Grey

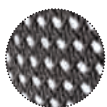

R2 / Round  
Rope Taupe

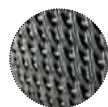

R4 / Round  
Rope Lava Grey



RFG / Flat Rope  
Grey



RCG / Round  
Rope Grey



RCS / Round  
Rope Sand

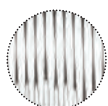

RCD / Round  
Rope Dark Grey



R52 / Round  
Rope Ruby Wine



R56 / Round  
Rope Olive Green



---

## Rattan



WN / Natural  
Rattan

---

## Fibra sintetica riciclabile / Recyclable synthetic fiber / Fibre synthétique recyclable / Synthetische recyclebare Faser



WNF / Natwick  
Sand Beige  
Tight Weave

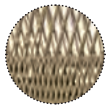

WNH / Natwick  
Sand Beige  
Wide Weave



W20 / Etwick  
Bark



W21 / Etwick  
White



W22 / Lightwick  
Warmgrey



W23 / Lightwick  
Warmwhite



RTW / Pvc  
Rope Turquoise

---

## Pietra ceramica / Ceramic stone / Pierre céramique / Keramik



LI / Ice White



LR / Stone  
Graphite



LL / Disegno



LS / Sand



LN / Slate Grey



LG / Dove Grey



LB / White



LT / Grey



LV / Black Vulcano



LP / Piombo Silk

---

## Pietre / Stones / Pierres / Steine



MS / Statuary  
Marble



PSR / Enamelled  
Lava Stone  
Smeraldo



PLSB / Enamelled  
Lava Stone  
Opaque White



PLA / Lava  
Stone Ardesia



CS / Concrete

---

## Cemento / Concrete / Ciment / Beton



# Materiali. Materials. Matériaux. Materialien.

---

## Laminato / Laminate / Laminé / Laminat



HN / Intense  
Black

---

## Terracotta / Terracotta / Terre cuite / Terrakotta



C64 / Terracotta



C65 / Red Earth



C66 / Mud Grey

---

## Vetro soffiato / Blown glass / Verre soufflé / Geblasenes Glas



V1 / Fumé  
Transparent



V3 / Amber  
Transparent



V4 / Light  
anthracite  
Transparent



V2 / Fumé  
Acid-etched



V3 / Amber  
Acid-etched



V5 / Light  
anthracite  
Acid-etched



VBA / White  
Acid-etched

---

## Polypropylene

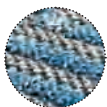

PP81 /  
Blue  
Indigo



PP80 /  
Green  
Seaweed



PP84 /  
Coconut



PP83 /  
Clay /  
Terracotta



---

Metallo / Metal / Métal / Metall



31 / Textured matt Lily of the valley White

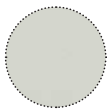

43 / Textured matt Warmwhite



44 / Textured matt Warmgrey



40 / Textured matt Mud Grey



53 / Textured matt Mineral Grey



51 / Textured matt Coffee Brown



G / Textured matt Dark Grey



48 / Textured matt Sepia Black



54 Textured matt Iris Blue

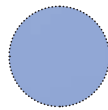

41 / Textured matt Plumbago Blue



55 / Textured Peacock



38 / Textured matt Olive Green



32 / Textured matt Sage Green



39 / Matt Bamboo Green

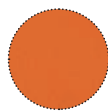

45 / Textured matt Orange



47 / Matt Poppy Red



R / Textured matt Warmred



34 / Glossy Periwinkle Lilac



52 / Aluminium

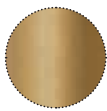

20 / Brass-plated aluminium



00 / Inox



# Tessuti. Fabrics. Tissus. Stoffe.

---

## Acrilici Waterproof / Acrylic Waterproof / Acrylique Waterproof / Wasserdichte Acrylstoffe



AW25 / Nature  
White

AW24 / Nature  
Grey

AW28 / Black  
Stone

AW39 /  
Espresso

---

## Acrilici / Acrylic / Acrylique / Acryl



A1 / Ivory

A25 / Nature  
White

A19 / Grey  
Sun

A24 / Nature  
Grey

A12 / Dove  
Grey

A39 / Espresso

A28 / Black  
Stone

A27 / Blue  
Naval



A17 / Avio

A56 / Charron

A15 / Leaf

A65 / Yellow  
Apache

A31 / Red  
Navajo

A29 / Cherry  
Red

A76 / Red  
Earth

A10 / Wisteria  
Lilac



A43 / Mariaflora  
White

A44 / Mariaflora  
Taupe

A42 / Mariaflora  
Blue

A46 / Lichen

A47 / Lichen  
Melange

A48 / Lichen  
Twill



Acrilici / Acrylic / Acrylique / Acryl



A109 / Checks  
Black And White



A58 / Checks  
Breeze



A62 / Checks  
Oliver Blue



A59 / Checks  
Oliver Green



A57 / Checks  
Wild Berry



A34 / Velvet  
Artic Grey



AV9 / Velvet  
Smoke



A30 / Velvet  
Blue



AV23 / Velvet  
Pavone



AV21 / Velvet  
Acqua



AV25 / Velvet  
Arancio



A106 / Thin Stripes  
Blue Navy/White  
Piping Blue Navy

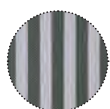

A101 / Thin Stripes  
Classic Green/  
White Piping Green



A119 / Thin Stripes  
Red/White Piping  
Red



A108 / Wide  
Stripes Blue Navy/  
White

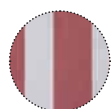

A105 / Wide  
Stripes Red/White



A103 / Wide  
Stripes Classic  
Green/White



A107 / Blue Navy  
Piping White



A102 / Classic  
Green Piping White



A104 / Red Piping  
White



# Tessuti. Fabrics. Tissus. Stoffe.

---

## Poliestere / Polyester / Polyester / Polyester

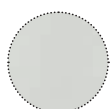

P7 / White

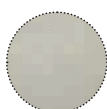

P25 / Hydro  
White

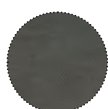

P9 / Dove Grey



P24 / Hydro  
Grey



P63 / Blu Ink



P61 / Green  
Sardinia



P60 / Hydro



P77 / Red



P11 / Rubelli  
Outcross  
Caraibe Rose



P12 / Rubelli  
Outcross Gris  
Saugé



P10 / Rubelli  
Outcross Olive  
Blue

---

## Ethitex / Ethitex / Ethitex / Ethitex



E57 / White



E52 / Dove Grey

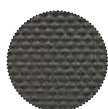

E37 / Cappuccino



E53 / Blue



E51 / Lilac



E56 / Red



E38 / Tartan

---

## Velum / Velum / Velum / Velum



V78 / White  
Stone

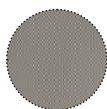

V75 / Grey  
Stone



V79 / Swell

---

## Rain cover / Rain cover / Housse de pluie / Regenhülle

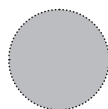

Rain Cover /  
Ethi-Care fabric  
Polyester + PVC



---

Polipropilene / Polypropylene / Polypropylène / Polypropylen



PP50 / Corda



PP51 / Lava



PPVA / Lime



PP35 /  
Geometric Terra



PP36 / Geometric  
Marine

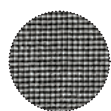

PP52 / Black &  
White Chess



PP53 / Red  
Diamonds

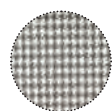

PP32 /  
Pool Ebano

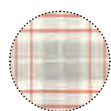

PP33 /  
Plaid Beige



PP1 / Rubelli  
Outmap  
Chartreuse



PP2 / Rubelli  
Outmap Ardoise



PP3 / Rubelli  
Outmap  
Laguna



PPR / Tricot  
Stripes

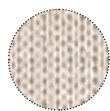

PPP / Tricot Panna

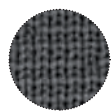

PPG / Tricot Grigio



PPB / Tricot  
Bordeaux







Ethimo.  
Informazioni tecniche.  
Technical information.  
Informations techniques.  
Technische Informationen.







## A

252 Agave  
234 Allaperto

## C

292 Carré  
282 Classic  
270 Clay  
286 Clostra  
287 Coimbra rug  
246 Concreto  
254 Costes  
266 Cronos  
271 Cruise  
278 Cube

## E

272 Elisir  
267 Elit  
267 Elle  
258 Enjoy  
242 Esedra  
265 Essenza

## F

261 Flat  
276 Flower  
285 Free  
284 Freedom  
265 Friends

## G

293 Ginger  
287 Goa rug  
228 Grand Life

## H

281 Holiday  
227 Hut

## I

262 Infinity

## K

248 Kilt  
238 Knit

## L

274 Laren  
280 Loto  
288 Lucerna

## M

287 Malindi rug  
290 Milk

## N

260 Nicolette  
268 Notting Hill

## O

264 Ocean

## P

270 Petit club  
287 Petra rug  
289 Pharos  
280 Phorma  
256 Play  
249 Pluvia

## R

222 Rafael  
250 Ribot

## S

269 Sand  
269 Sandy  
290 Shake  
264 Smart  
291 Step  
261 Studios  
230 Swing

## T

270 T-Box

## V

220 Venexia



# Venexia

Luca Nichetto  
Collection composed of: lounge armchair  
/ 2 seater sofa / back end module  
/ cup holder / round coffee table.



## Material - Frame



Aluminium  
Mineral Grey

## Material - Table top



Enamelled  
Lava Stone  
Opaque White



Lava Stone  
Ardesia

## Fabrics



Acrylic  
Lichen



Acrylic  
Lichen Melange



Acrylic  
Lichen Twill

## Cup holder



Pickled  
Teak



Ethi-Care

## Lounge armchair

VXPLD53

cushions, seat+3back lichen VXCUPLA46

→ 26

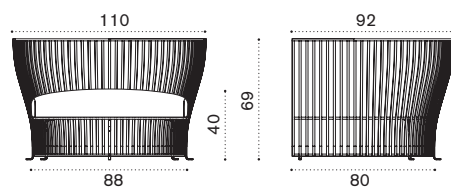

## 2 seater sofa

VXD2D53

cushions, seat+5back lichen VXCUD2A46

→ 40,5

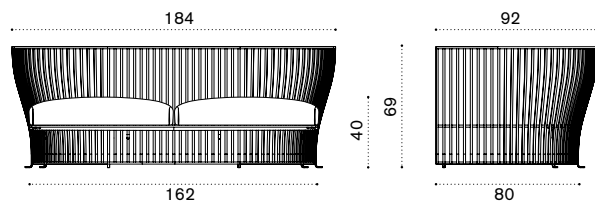

220

Ethimo



# Venexia

## Back end module left

VXFSD53

cushions, seat+4back lichen VXCUGA46

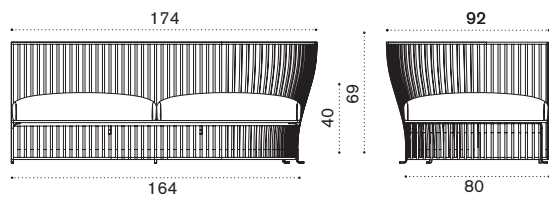

 → 35 



## Back end module right

VXFDD53

cushions, seat+4back lichen VXCUGA46

 → 35 

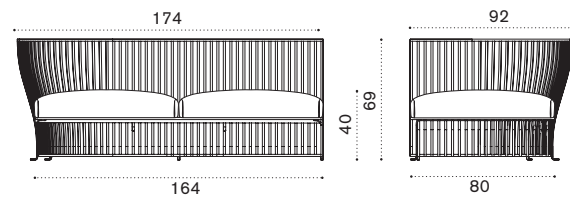

## Cup holder Ø 25

VXPBT5

 → 0,5

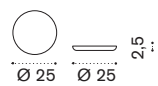

## Complementary back cushion 40x40

lichen melange VXCUSCM1A47

lichen twill VXCUSCM1A48

 → 0,5  

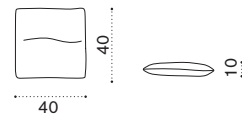

## Coffee table Ø 60 H48

alu. mineral grey + white VXTCTM1D53PLSB

alu. mineral grey + ardesia VXTCTM1D53PLA

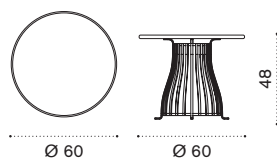

 → 16,5 



## Coffee table Ø 90 H43

alu. mineral grey + white VXTCTM2D53PLSB

alu. mineral grey + ardesia VXTCTM2D53PLA

 → 38 

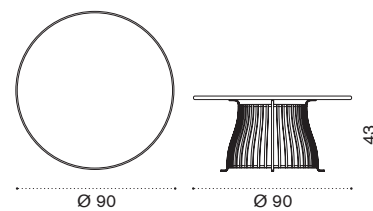



# Rafael

Paola Navone

Collection composed of: lounge armchair / daybed / lounge armchair with integrated coffee table / coffee table / sunbed / dining table / dining armchair.



## Material - Frame



## Material - Table top

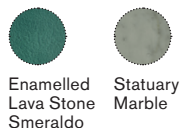

## Material - Rope



## Rain cover



## Sunbed Fabrics

### Mood Black & White

#### Sunbed Mattress

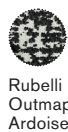

#### Sunbed Back cushion 90x45



#### Sunbed Roller cushion L90 Ø 17



### Mood Laguna



### Mood Aria

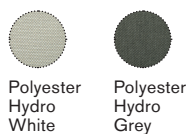

# Rafael

## Sofa Fabrics

Mood  
Olive + Blue

Seat cushions



Rubelli  
Outmap  
Chartreuse

Back cushion 55x55



Rubelli  
Outmap  
Chartreuse



Rubelli  
Outcross  
Olive Blue

Back cushion 45x45



Rubelli  
Outmap  
Chartreuse



Rubelli  
Outcross  
Olive Blue



Mariaflora  
Blue

Mood  
Black & White



Rubelli  
Outmap  
Ardoise



Rubelli  
Outmap  
Ardoise



Rubelli  
Outcross  
Caraibe  
Rose



Rubelli  
Outmap  
Ardoise



Rubelli  
Outcross  
Caraibe  
Rose



Mariaflora  
White

Mood  
Laguna



Rubelli  
Outmap  
Laguna



Rubelli  
Outmap  
Laguna



Rubelli  
Outcross  
Gris Sauge



Rubelli  
Outmap  
Laguna



Rubelli  
Outcross  
Gris Sauge



Mariaflora  
Taupe

Mood  
Aria



Polyester  
Hydro  
White



Polyester  
Hydro  
Grey



Polyester  
Hydro  
White



Polyester  
Hydro  
Grey



Polyester  
Hydro  
Acqua



Polyester  
Hydro  
White



Polyester  
Hydro  
Grey



Polyester  
Hydro  
Acqua

Mood  
Neve



Checks  
Black And  
White



Velvet  
Smoke



Checks  
Black And  
White



Velvet  
Smoke



Checks  
Black  
And  
White



Velvet  
Smoke



Tricot  
Stripes



Tricot  
Panna

Mood  
Breeze



Checks  
Breeze



Checks  
Oliver Blue



Checks  
Breeze



Checks  
Oliver Blue



Velvet  
Pavone



Checks  
Breeze



Velvet  
Smoke



Velvet  
Pavone



Tricot  
Grigio

Mood  
Wild Berry



Checks  
Wild Berry



Checks  
Oliver Green



Velvet  
Arancio



Checks  
Wild Berry



Checks  
Oliver Green



Velvet  
Arancio



Velvet  
Arancio



Velvet  
Acqua



Checks  
Oliver  
Green



Tricot  
Bordeaux



# Rafael

Paola Navone

Collection composed of:

lounge armchair / daybed / lounge armchair with integrated coffee table / coffee table / sunbed / dining table / dining armchair.

## Lounge armchair right

brushed natural teak RAPLDT1S  
pickled teak RAPLDT5  
seat cushion RACUPLD\_\_\_

kg → 35

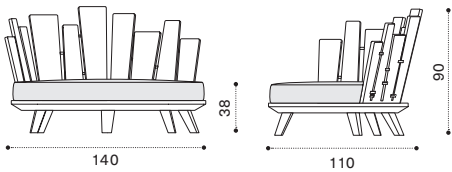

## Lounge armchair left

brushed natural teak RAPLST1S  
pickled teak RAPLST5  
seat cushion RACUPLS\_\_\_

kg → 35

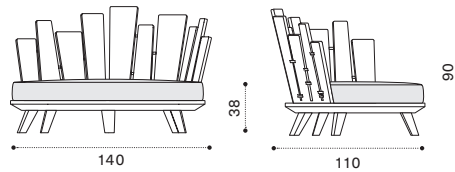

## Daybed right

brushed natural teak RADDT1S  
pickled teak RADDT5  
seat cushion RACUDD\_\_\_

kg → 60,5

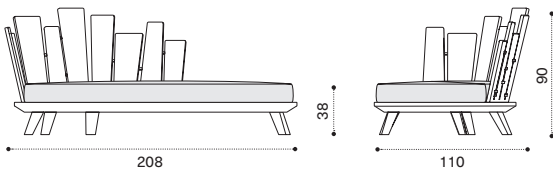

## Daybed left

brushed natural teak RADST1S  
pickled teak RADST5  
seat cushion RACUDS\_\_\_

kg → 60,5

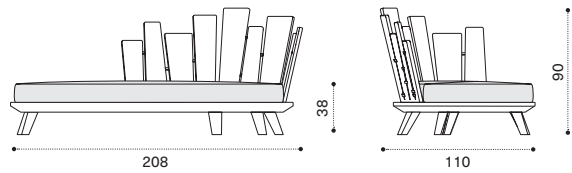

## Lounge armchair right with integrated coffee table

brushed natural teak + marble RAD2T1STDMS  
brushed natural teak + smeraldo RAD2T1STDPSR  
pickled teak + marble RAD2T5TDMS  
pickled teak + smeraldo RAD2T5TDPSR  
seat cushion RACUD2TD\_\_\_

kg → 68,5

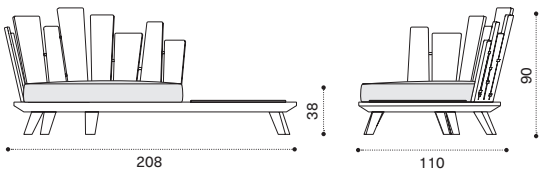

## Lounge armchair left with integrated coffee table

brushed natural teak + marble RAD2T1STSMS  
brushed natural teak + smeraldo RAD2T1STSPSR  
pickled teak + marble RAD2T5TSMS  
pickled teak + smeraldo RAD2T5TSPSR  
seat cushion RACUD2TS\_\_\_

kg → 68,5

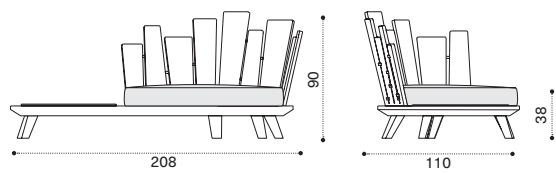

## Back cushion 45x45 cm

RACUSCM1\_\_\_

kg → 1

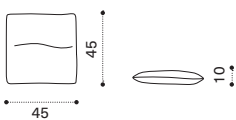

224

## Back cushion 55x55 cm

RACUSCM2\_\_\_

kg → 1

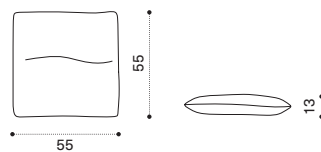

Ethimo

# Rafael

## Coffee table 68 x 70 - small

brushed natural teak + marble RATCQT1SMS  
brushed natural teak + smeraldo RATCQT1SPSR

 → 26

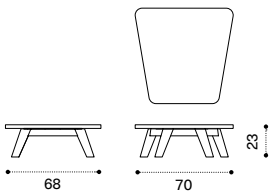

## Coffee table 68 x 70 - small

pickled teak + marble RATCQT5MS  
pickled teak + smeraldo RATCQT5PSR

 → 26

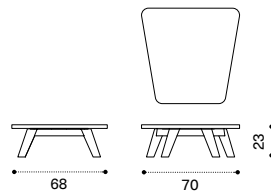

## Coffee table 70 x 170 - large

brushed natural teak + marble RATCRT1SMS  
brushed natural teak + smeraldo RATCRT1SPSR

 → 40

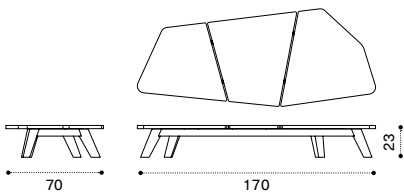

## Coffee table 70 x 170 - large

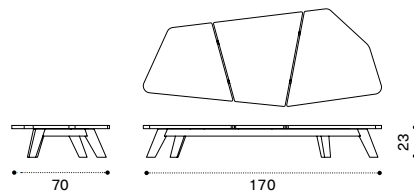

pickled teak + marble RATCRT5MS  
pickled teak + smeraldo RATCRT5PSR

 → 40



## Sunbed

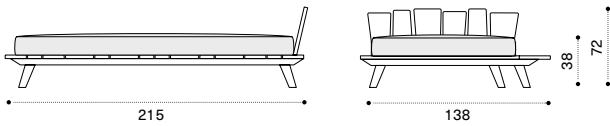

brushed natural teak RALET1S  
pickled teak RALET5  
seat cushion RACULEP\_

 → 40  



## Sunbed roller cushion 90x Ø 17

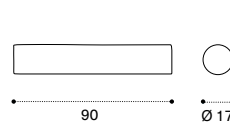

RACULEPR\_

 → 1  



## Sunbed back cushion 90x45 cm

RACULESC\_

 → 1,5  

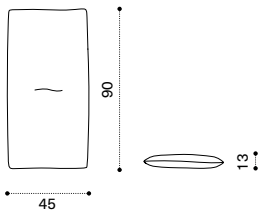



# Rafael

Paola Navone

Collection composed of:

lounge armchair / daybed / lounge armchair  
with integrated coffee table / coffee table  
/ sunbed / dining table / dining armchair.

## Octagonal dining table 160 x 160

brushed natural teak + marble RATPQM1T1SMS  
brushed natural teak + smeraldo RATPQM1T1SPSR  
pickled teak + marble RATPQM1T5MS  
pickled teak + smeraldo RATPQM1T5PSR

→ 160 → 8

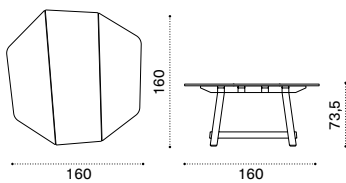

## Dining table 264 x 154

brushed natural teak + marble RATPRM1T1SMS  
brushed natural teak + smeraldo RATPRM1T1SPSR  
pickled teak + marble RATPRM1T5MS  
pickled teak + smeraldo RATPRM1T5PSR

→ 255 → 10

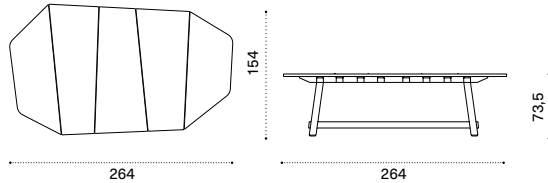

## Round dining table Ø 230

brushed natural teak RATPTM1T1S  
pickled teak RATPTM1T5  
statuary marble rotating tray RAPGMS

→ 177 → 12

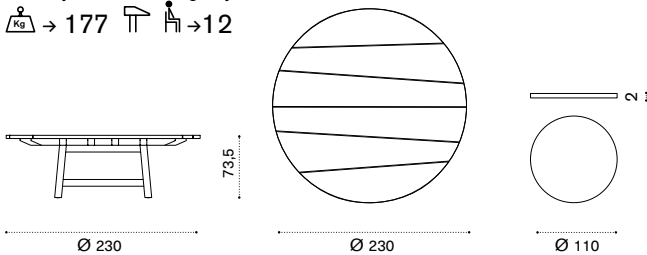

## Dining armchair

brushed natural teak RAPDT1SR1  
pickled teak RAPDT5R1

→ 6

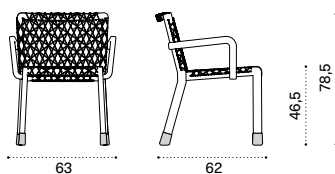

226

Ethimo

# Hut

Atelier Lavit  
Collection composed of: alcove.

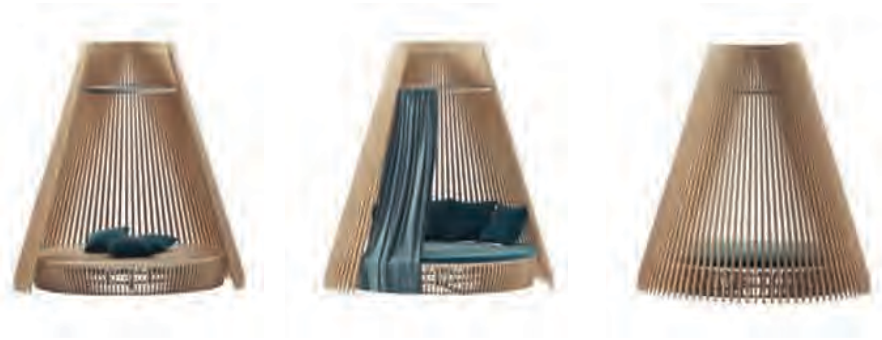

## Material - Frame



Aluminium

Accoya®

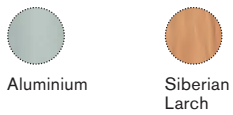

Aluminium

Siberian Larch

## Fabrics

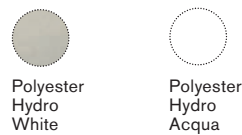

Polyester Hydro White

Polyester Hydro Acqua



Acrylic Charron

## Fabrics

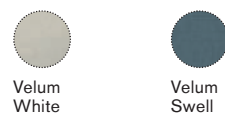

Velum White

Velum Swell

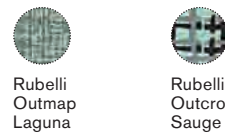

Rubelli Outmap Laguna

Rubelli Outcross Gris Saugé

## Alcove Ø 3m x h3,25m

Accoya® HUNIT1A  
Siberian Larch HUNIT1L  
mattress Ø 2,7m h8cm HUCUNI\_\_\_\_  
curtain 2,8x2,65 m HUTDV\_\_\_\_  
decorative cushion 55x55 cm  
RACUSCM1\_\_\_\_

→ 360

## Round lounge bed

Ø 2,7m x h44 cm  
Accoya® HULBT1A  
Siberian Larch HULBT1L  
mattress Ø 2,7m h8cm HUCUNI\_\_\_\_  
decorative cushion 55x55 cm  
RACUSCM1\_\_\_\_

→ 161

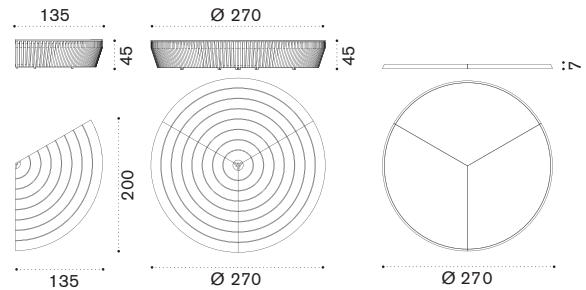

## Wooden shelter Ø 3m x

h3,25m

Accoya® HUGUT1A  
Siberian Larch HUGUT1L  
curtain 2,8x2,65 m HUTDV\_\_\_\_

→ 199

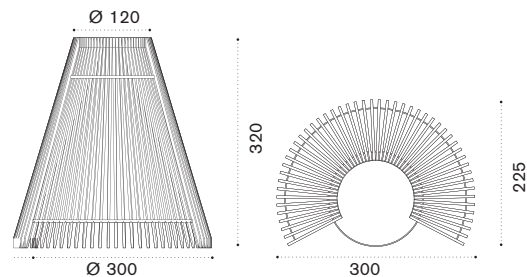
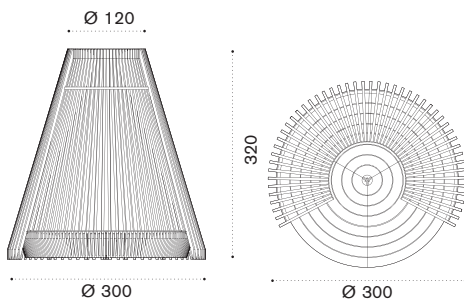

Technical info



# Grand Life

Christophe Pillet

Collection composed of: bergère / lounge  
armchair / XL sofa / coffee table / sunbed.



## Material - Frame



Natural Teak



Light Grey Round Rope



Ceramic Stone Ice white



Ceramic Stone Sand



Pickled Teak



Taupe Round Rope

## Fabrics



Acrylic Nature White



Acrylic Nature Grey



Polypropylene Corda

## Rain cover



Ethi-Care

## Bergère

natural teak GLPIT1R1  
pickled teak GLPIT5R2  
cushions, seat+back GLCUPL\_\_\_\_\_

→ 19

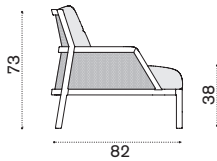
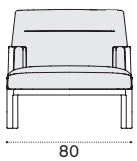

## Lounge armchair

natural teak GLPLT1R1  
pickled teak GLPLT5R2  
cushions, seat+back GLCUPL\_\_\_\_\_

→ 28,5

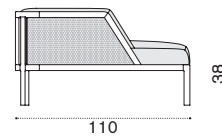
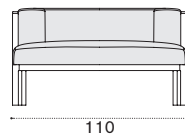

## XL sofa

natural teak GLD3T1R1  
pickled teak GLD3T5R2  
cushions, seat+back GLCUDI\_\_\_\_\_

→ 52

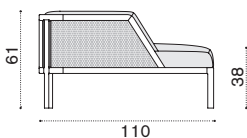
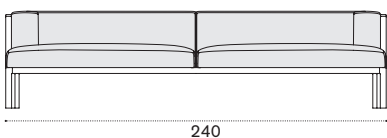

228

## Complementary back cushion for XL sofa and armchair

nature white GLCUSCAW25  
nature grey GLCUSCAW24  
corda GLCUSCPP50

→ 1,3

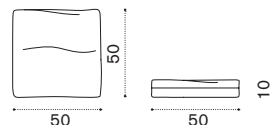

Ethimo

# Grand Life

## Coffee table Ø 77 h25

natural teak + ceramic stone ice white GLTCTH1T1LI  
 pickled teak + ceramic stone sand GLTCTH1T5LS

 → 9

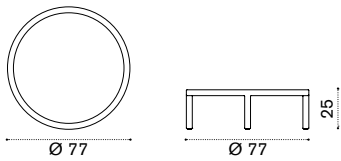

## Coffee table Ø 77 h45

natural teak + ceramic stone ice white GLTCTH2T1LI  
 pickled teak + ceramic stone sand GLTCTH2T5LS

 → 9

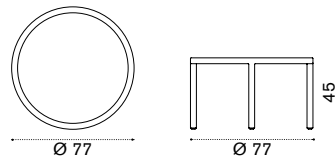

## Rectangular coffee table 100x65 h25

natural teak + ceramic stone ice white GLTCRHT1LI  
 pickled teak + ceramic stone sand GLTCRHT5LS

 → 10

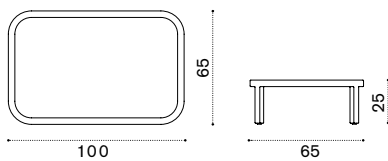

## Square coffee table 100x100 h35

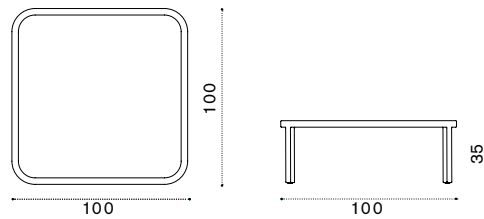

natural teak + ceramic stone ice white GLTCQHT1LI  
 pickled teak + ceramic stone sand GLTCQHT5LS

 → 15



## Sunbed

natural teak + mattress GLLET1\_\_\_\_  
 pickled teak + mattress GLLET5\_\_\_\_

 → 29  

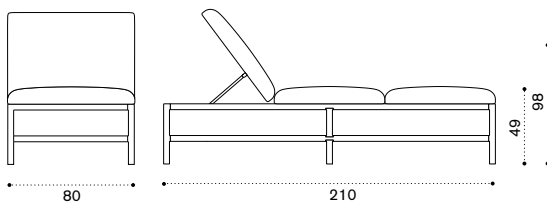

Technical info



# Swing

Patrick Norguet

Collection composed of: 2 seater sofa / porch swing / XL sofa / lounge armchair / modular sofa / daybed / small and large coffee table / club armchair / barstool / dining armchair / round and rectangular dining table / pouf.



## Material



Pickled Teak



Natural Teak



Aluminium Sepia Black



Aluminium Warmwhite



Aluminium Warmred



Aluminium Olive Green

## Fabrics



Acrylic Nature Grey



Velum White stone



Polypropylene Chess



Polyester Blu Ink



Polyester Green Sardinia

## Rain cover



Ethi-Care

# Swing

## 2 seater sofa

pickled teak SWD2D\_\_T5  
 natural teak SWD2D\_\_T1  
 cushions, seat + 2 back SWCUD2AW24

→ 43

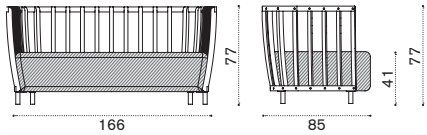

## Porch swing

→ 84

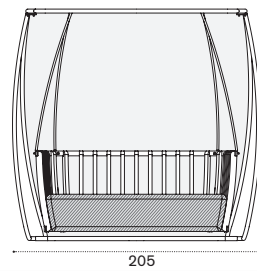

pickled teak SWDOD\_\_T5  
 natural teak SWDOD\_\_T1  
 cushions, seat + 2 back SWCUD2AW24  
 curtain SWTEDOV78

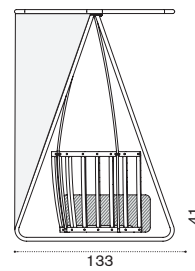

## XL sofa

pickled teak SWD3D\_\_T5  
 natural teak SWD3D\_\_T1  
 cushions, seat + 3 back SWCUD3AW24

→ 59

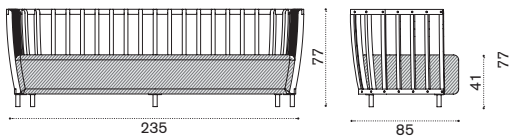

## Lounge armchair

pickled teak SWPLD\_\_T5  
 natural teak SWPLD\_\_T1  
 cushions, seat + back SWCUPLAW24

→ 29

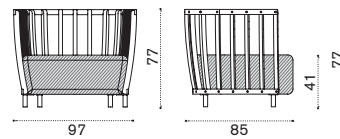

## Corner module

pickled teak SWDMAUD\_\_T5  
 natural teak SWDMAUD\_\_T1  
 cushions, seat + 2 back SWCUDMAUAW24

→ 30

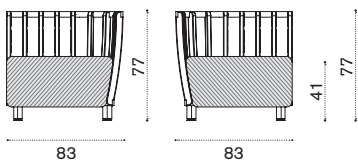

## XL central module

pickled teak SWDMCD\_\_T5  
 natural teak SWDMCD\_\_T1  
 cushions, seat + 2 back SWCUDMCAW24

→ 35

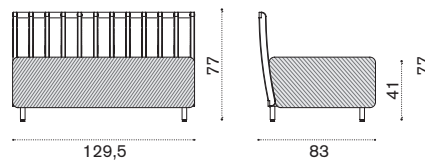

## Daybed left

pickled teak SWDMDS\_\_T5  
 natural teak SWDMDS\_\_T1  
 cushions, seat+2 back SWCUDMDSAW24

→ 39

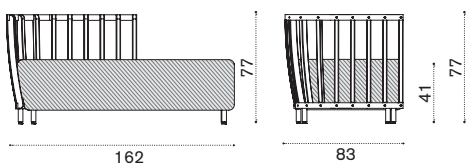

## Daybed right

pickled teak SWDMDD\_\_T5  
 natural teak SWDMDD\_\_T1  
 cushions, seat+2 back SWCUDMDDAW24

→ 39

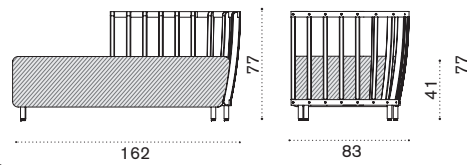



# Swing

Patrick Norguet

Collection composed of: 2 seater sofa / porch swing / XL sofa / lounge armchair / modular sofa / daybed / small and large coffee table / club armchair / barstool / dining armchair / round and rectangular dining table / pouf.

## Back end module left

pickled teak SWDMFSD\_\_T5  
natural teak SWDMFSD\_\_T1  
cushions, seat+3 back SWCUDMFSAW24

→ 45

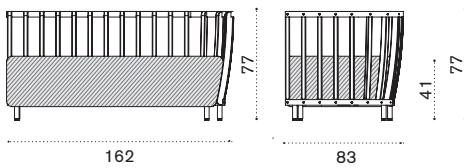

## Back end module right

pickled teak SWDMFDD\_\_T5  
natural teak SWDMFDD\_\_T1  
cushions, seat+3 back SWCUDMFDW24

→ 45

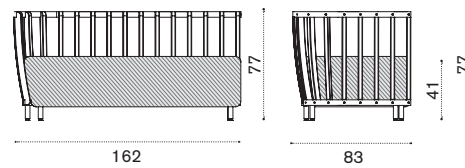

## Small coffee table Ø 50

pickled teak SWTCQH2D\_\_T5  
natural teak SWTCQH2D\_\_T1

→ 9

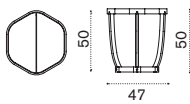

## Large coffee table 110x57

pickled teak SWTCRH1D\_\_T5  
natural teak SWTCRH1D\_\_T1

→ 20

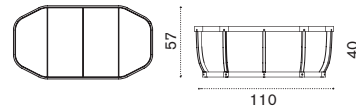

## Club armchair

pickled teak SWPCD\_\_T5  
natural teak SWPCD\_\_T1  
cushions, seat+back SWCUPCAW24

→ 14

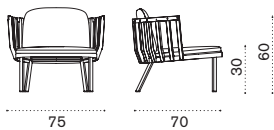

## Barstool

pickled teak SWSGD\_\_T5  
natural teak SWSGD\_\_T1  
cushions, seat+back SWCUPD\_\_\_\_\_

→ 9

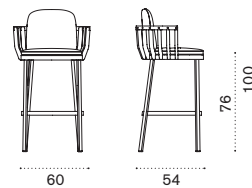

## Dining armchair

pickled teak SWPDD\_\_T5  
natural teak SWPDD\_\_T1  
cushions, seat+back SWCUPD\_\_\_\_\_

→ 6,5

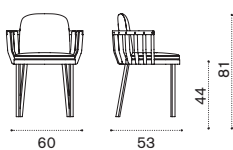

232

Ethimo

# Swing

## Rectangular dining table 240x100

pickled teak SWTPRM2D\_\_T5  
natural teak SWTPRM2D\_\_T1

→ 48 → 8

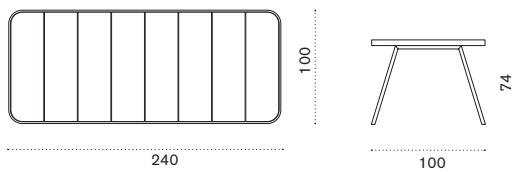

## Round dining table Ø 140

pickled teak SWPTM1D\_\_T5  
natural teak SWPTM1D\_\_T1

→ 35 → 6-7

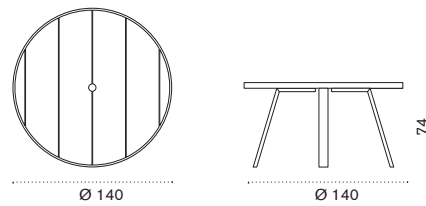

## Pouf Ø 40 h38

pickled teak + seat cushion SWPM11D\_\_T5\_\_\_  
natural teak + seat cushion SWPM11D\_\_T1\_\_\_

→ 5

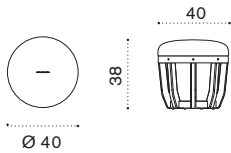

## Pouf Ø 40 h46

pickled teak + seat cushion SWPM12D\_\_T5\_\_\_  
natural teak + seat cushion SWPM12D\_\_T1\_\_\_

→ 6,5

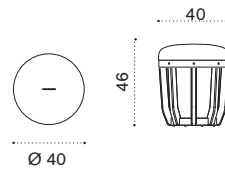

## Pouf Ø 60 h38

pickled teak + seat cushion SWPM21D\_\_T5\_\_\_  
natural teak + seat cushion SWPM21D\_\_T1\_\_\_

→ 10,5

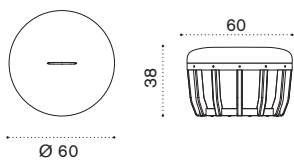

## Pouf Ø 60 h46

pickled teak + seat cushion SWPM22D\_\_T5\_\_\_  
natural teak + seat cushion SWPM22D\_\_T1\_\_\_

→ 13,5

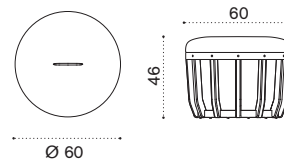

## Pouf Ø 140 h38

pickled teak + seat cushion SWPM31D\_\_T5\_\_\_  
natural teak + seat cushion SWPM31D\_\_T1\_\_\_

→ 42

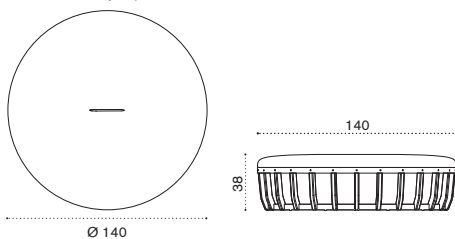

## Pouf Ø 140 h46

pickled teak + seat cushion SWPM32D\_\_T5\_\_\_  
natural teak + seat cushion SWPM32D\_\_T1\_\_\_

→ 48

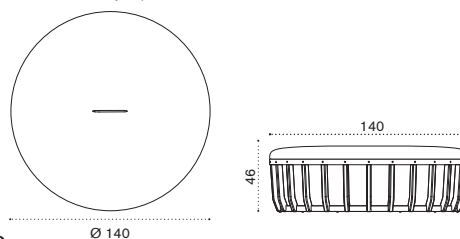



# Allaperto

Matteo Thun & Antonio Rodriguez  
Collection composed of: lounge armchair / 2 seater sofa / square and rectangular coffee table / sunbed / lounge bed / hanging armchair / free-standing outdoor swings.

## — Mountain



### Material - Etwick version



Metal Coffee Brown



Pickled Teak



Etwick Bark



Velum Grey Stone

### Material - Tartan version



Metal Coffee Brown



Natural Teak



Ethitex Tartan padded

### Accessories



Cushion acrylic Red Navajo with Velvet Blue piping



Sleeping bag



Cushion acrylic Espresso

### Rain cover



Ethi-Care

## — Nautic



### Material



Metal Coffee Brown



Natural Teak



Flat Rope Grey

234

### Cushion



Blue Navy Piping White



Classic Green Piping White



Thin Stripes Classic Green/White Piping Green



Thin Stripes Red/White Piping Red

### Cushion



Red Piping White



Wide Stripes Blue Navy/White



Thin Stripes Blue Navy/White Piping Blue Navy



Wide Stripes Red/White



Wide Stripes Classic Green/White

Ethimo

### Rain cover



Ethi-Care

# Allaperto

## – Urban



## – Camping chic



### Material - Urban



Metal Coffee  
Brown



Pickled Teak



Metal  
Warmwhite



Mahogany  
Ostuni White



Ethitex  
Cappuccino  
padded



Velum Grey  
Stone



Pvc rope  
Turquoise



Polypropylene  
Lime

### Rain cover



Ethi-Care

## – Veranda



### Material



Metal Coffee  
Brown



Natural  
Teak



Natural  
Rattan

### Cushion



Blue Navy  
Piping White



Classic Green  
Piping White



Thin Stripes  
Classic Green/  
White Piping  
Green



Thin Stripes  
Red/White  
Piping Red

### Cushion



Red  
Piping White



Wide Stripes  
Blue Navy/White



Thin Stripes  
Blue Navy/White  
Piping Blue Navy



Wide Stripes  
Red/White



Wide Stripes  
Classic Green/  
White

### Rain cover



Ethi-Care



# Allaperto

Matteo Thun & Antonio Rodriguez  
Collection composed of: lounge armchair  
/ 2 seater sofa / square and rectangular  
coffee table / sunbed / lounge bed / hanging  
armchair / free-standing outdoor swings.

## Lounge armchair

**Allaperto Mountain** Etwick AAPLS51T5W20  
seat cushion espresso AACUSEPLAW39  
**Allaperto Mountain** Tartan AAPLS51T1E38  
sleeping bag AASBPPMA  
lumbar cushion red navajo with velvet blue piping AACULBA31

**Allaperto Urban** AAPLS51T1E37

**Allaperto Camping chic** AAPLS43M3RTW  
seat and back cushion lime AACUPLPPVA

**Allaperto Nautic** AAPLS51T1RFG  
lumbar cushion AACULBM2\_\_\_\_  
decor cushion AACUDCQ\_\_\_\_

**Allaperto Veranda** AAPLS51T1WN  
lumbar cushion AACULBM2\_\_\_\_  
decor cushion AACUDCQ\_\_\_\_

 → 12-14

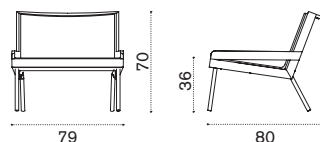

## 2 seater sofa

**Allaperto Mountain** Etwick AAD2S51T5W20  
seat cushion espresso AACUSED2AW39  
**Allaperto Mountain** Tartan AAD2S51T1E38  
sleeping bag AASBPPMA  
lumbar cushion red navajo with velvet blue piping AACULBA31

**Allaperto Urban** AAD2S51T1E37  
lumbar cushion AACULBM2\_\_\_\_  
decor cushion AACUDCQ\_\_\_\_

**Allaperto Nautic** AAD2S51T1RFG  
lumbar cushion AACULBM2\_\_\_\_  
decor cushion AACUDCQ\_\_\_\_

 → 18-21

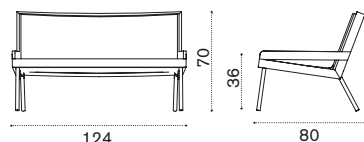

## Square coffee table 50x50

**Allaperto Mountain** Etwick AATCQB51T5  
**Allaperto Mountain** Tartan AATCQB51T1

**Allaperto Urban** AATCQB51T5

**Allaperto Nautic** AATCQB51T1

**Allaperto Veranda** AATCQB51T1

 → 8

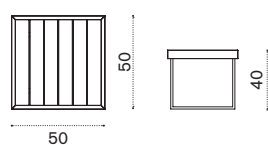

236

## Rectangular coffee table 100x70

**Allaperto Mountain** Etwick AATCRB51T5  
**Allaperto Mountain** Tartan AATCRB51T1

**Allaperto Urban** AATCRB51T5

**Allaperto Nautic** AATCRB51T1

**Allaperto Veranda** AATCRB51T1

 → 16

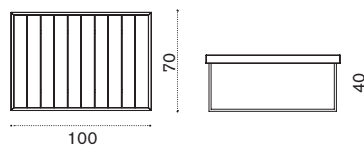

Ethimo

# Allaperto

## Sunbed

**Allaperto Mountain** Etwick AALES51T5W20  
mattress espresso AACULEAW39  
lumbar cushion red navajo with velvet blue piping AACULBA31

**Allaperto Urban** AALES51T1E37

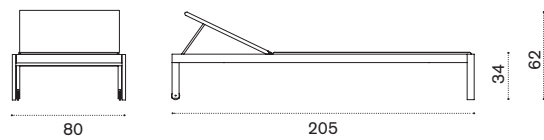
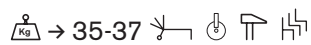

## Lounge bed

Curtains included  
**Allaperto Mountain** Etwick AAALB51T5W20  
2 mattresses espresso AACUALAW39  
lumbar cushion red navajo with velvet blue piping AACULBA31

**Allaperto Urban** AAALB51T5E37

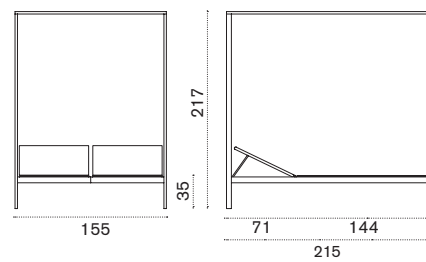
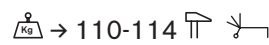

## Hanging armchair

**Allaperto Mountain** Etwick AAPLAS51T5W20  
seat cushion espresso AACUSEPLAW39  
lumbar cushion red navajo with velvet blue piping AACULBA31  
sleeping bag AASBPPMA

**Allaperto Nautic** AAPLAS51T1RFG  
lumbar cushion AACULBM2\_\_\_\_  
decor cushion AACUDCQ\_\_\_\_

**Allaperto Veranda** AAPLAS51T1WN  
lumbar cushion AACULBM2\_\_\_\_  
decor cushion AACUDCQ\_\_\_\_

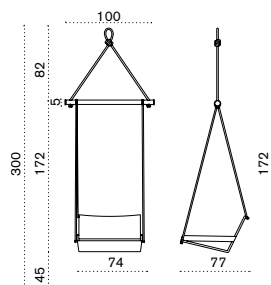
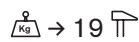

## Free-standing outdoor swings

**Allaperto Mountain** Etwick AA2ACS51T5W20  
seat cushion espresso AACUSEPLAW39  
lumbar cushion red navajo with velvet blue piping AACULBA31  
sleeping bag AASBPPMA

**Allaperto Nautic** AA2ACS51T1RFG  
lumbar cushion AACULBM2\_\_\_\_  
decor cushion AACUDCQ\_\_\_\_

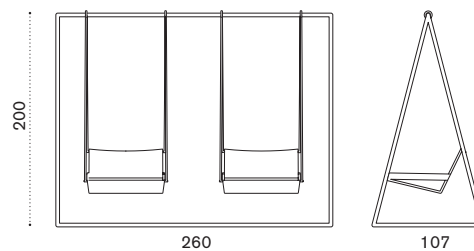
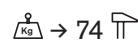



# Knit

Patrick Norguet  
 Collection composed of: armchair / 3 seater sofa / lounge armchair / 2 seater sofa / lounge high back armchair / rocking lounge armchair / footstool / coffee table / dining armchair / dining chair / square, rectangular and round dining table.



## Material



Natural Teak +  
Flat Rope Lava Grey



Pickled Teak +  
Flat Rope Light Grey

## Fabrics



Acrylic  
Black Stone



Acrylic  
Nature Grey

## Fabrics



Polypropylene  
Lava



Polypropylene  
Corda



Polypropylene  
Chess



Polypropylene  
Red Diamonds

## Rain cover



Ethi-Care

# Knit

## 3 seater sofa

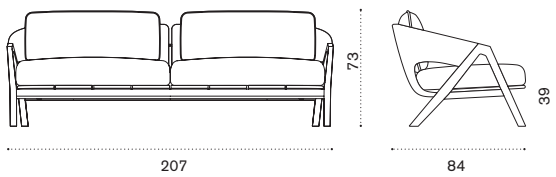

natural teak KND3T1R70  
pickled teak KND3T5R71  
cushions, seat+back KNCUD3PP\_\_

 → 41 



## Armchair

natural teak KNPLH1T1R70  
pickled teak KNPLH1T5R71  
cushions, seat+back KNCUPLH1PP\_\_

 → 21 

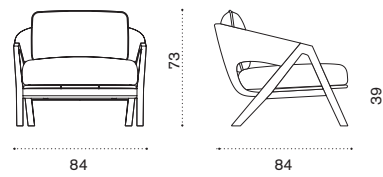

## Lumbar cushion for 3 seater sofa

2 lumbar cushions red diamond KNCUDCM2PP53

 → 1

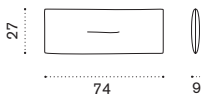

## Lumbar cushion for armchair

1 lumbar cushion red diamond KNCUDCM1PP53

 → 0,5

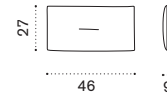

## 2 seater sofa

natural teak KND2T1R70  
pickled teak KND2T5R71  
lumbar cushions KNCULBD2\_\_

 → 16

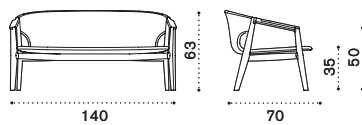

## Lounge armchair

natural teak KNPLT1R70  
pickled teak KNPLT5R71  
lumbar cushions KNCULBPL\_\_

 → 9

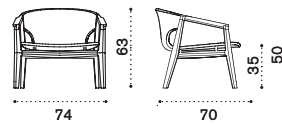



# Knit

Patrick Norguet

Collection composed of: armchair / 3 seater sofa / lounge armchair / 2 seater sofa / lounge high back armchair / rocking lounge armchair / footstool / coffee table / dining armchair / dining chair / square, rectangular and round dining table.

## Lounge high back armchair

natural teak KNPLH2T1R70  
pickled teak KNPLH2T5R71  
lumbar cushions KNCULBPL\_\_\_

 → 16

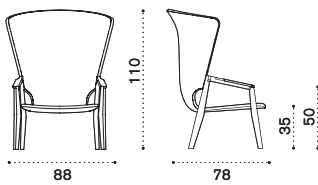

## Rocking armchair

natural teak KNPLH2RKT1R70  
pickled teak KNPLH2RKT5R71  
lumbar cushions KNCULBPL\_\_\_

 → 18

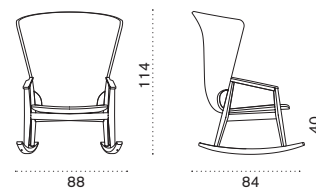

## Lumbar cushion

black stone KNCULBPLAW28  
nature grey KNCULBPLAW24  
red diamonds KNCULBPLPP53

 → 0,2

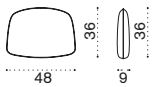

## Footstool

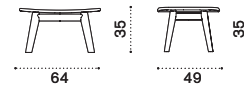

natural teak KNFTT1R70  
pickled teak KNFTT5R71

 → 5



## Rectangular coffee table 137x75

natural teak KNTCRM1T1  
pickled teak KNTCRM1T5

 → 17 

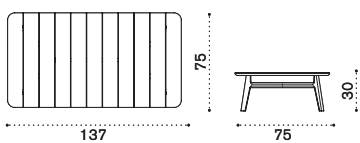

240

## Round coffee table Ø 50

natural teak KNTCTT1  
pickled teak KNTCTT5

 → 4

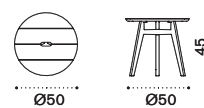

Ethimo

# Knit

## Dining chair

natural teak KNSET1R70  
pickled teak KNSET5R71

 → 6,5

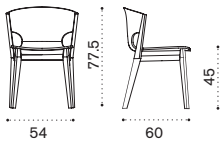

## Dining armchair

natural teak KNPDT1R70  
pickled teak KNPDT5R71

 → 7

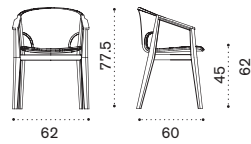

## Square dining table 90x90

natural teak KNTPQT1  
pickled teak KNTPQT5

 → 17  → 4

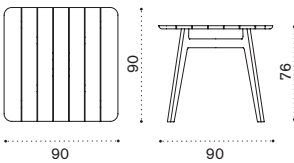

## Round dining table Ø 110

natural teak KNTPTT1  
pickled teak KNTPTT5

 → 27  → 5

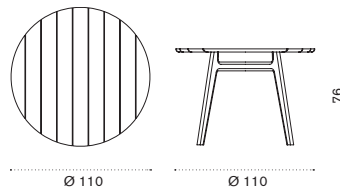

## Rectangular dining table 200x100

natural teak KNTPRM1T1  
pickled teak KNTPRM1T5

 → 70  → 6-8

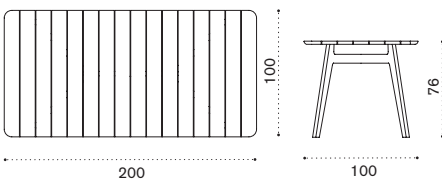

## XL rectangular dining table 263x110

natural teak KNTPRM2T1  
pickled teak KNTPRM2T5

 → 95  → 10

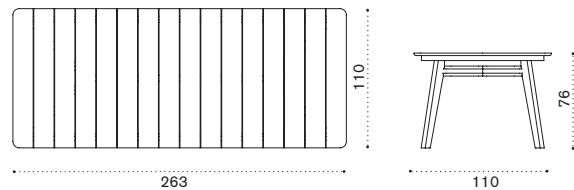



# Esedra

Luca Nichetto  
 Collection composed of: 3 seater sofa / lounge armchair / coffee table / square, rectangular and oval dining table / dining armchair / sun lounger.



## Material - Frame



Natwick  
Tight  
Weave



Natwick  
Wide  
Weave



Aluminium  
Warmwhite



Aluminium  
Dark Grey

## Material - Table top



Ceramic Stone  
Slate Grey



Ceramic Stone  
Dove Grey



Pickled Teak

## Fabrics



Acrylic  
Nature White



Acrylic  
Black Stone

## Rain cover



Ethi-Care

# Esedra

## Lounge armchair

natwick tight weave ESPLH1WNFD\_\_  
 natwick wide weave ESPLH1WNHD\_\_  
 cushions, seat+3 back ESCUPLA\_\_

 → 32

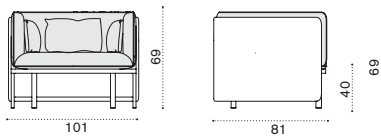

## Lounge high back armchair

natwick tight weave ESPLH2WNFD\_\_  
 natwick wide weave ESPLH2WNHD\_\_  
 cushions, seat+3 back ESCUPLA\_\_  
 headrest cushion ESCUTEA\_\_

 → 35

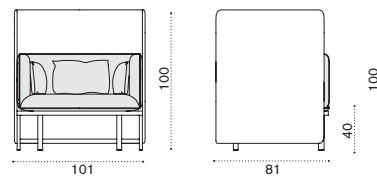

## 3 seater sofa

natwick tight weave ESD3H1WNFD\_\_  
 natwick wide weave ESD3H1WNHD\_\_  
 cushions, seat+5 back ESCUD3A\_\_

 → 50

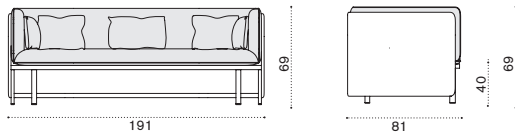

## 3 seater high back sofa

natwick tight weave ESD3H2WNFD\_\_  
 natwick wide weave ESD3H2WNHD\_\_  
 cushions, seat+5 back ESCUD3A\_\_  
 headrest cushion ESCUTEA\_\_

 → 53

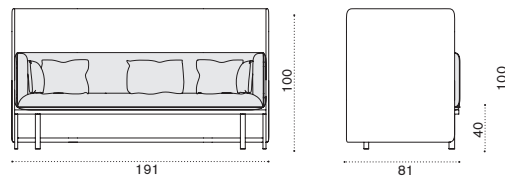

## Square coffee table 90x90

with slate grey ceramic stone top ESTCQD\_\_LN  
 with dove grey ceramic stone top ESTCQD\_\_LG

 → 21

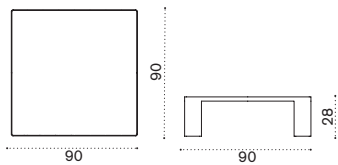

## Square coffee table 90x90

with pickled teak top ESTCQD\_\_T5

 → 19

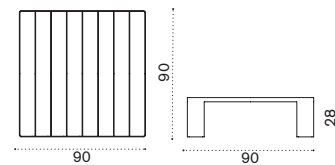

## Round coffee table Ø 56

with slate grey ceramic stone top ESTCTD\_\_LN  
 with dove grey ceramic stone top ESTCTD\_\_LG

 → 9

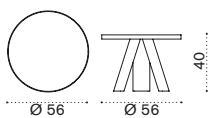

## Round coffee table Ø 56

with pickled teak top ESTCTD\_\_T5

 → 9

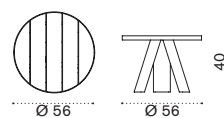



# Esedra

Luca Nichetto

Collection composed of: 3 seater sofa / lounge armchair / coffee table / square, rectangular and oval dining table / dining armchair / sun lounger.

## Oval coffee table 160x80

with pickled teak top ESTCOD\_\_T5

 → 21

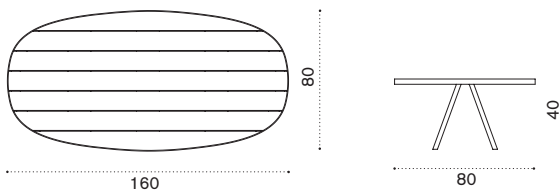

## Dining armchair

natwick tight weave ESPDH1WNFD\_\_  
natwick wide weave ESPDH1WNHD\_\_  
cushions, seat+back ESCUPDA\_\_

 → 13

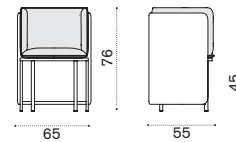

## Square dining table 90x90

with ceramic stone top slate grey ESTPQD\_\_LN  
with ceramic stone top dove grey ESTPQD\_\_LG

 → 23  → 4

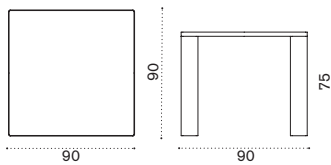

## Square dining table 90x90

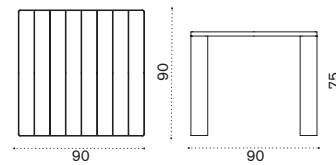

with pickled teak top ESTPQD\_\_T5

 → 20  → 4



## Rectangular dining table 200x99

with slate grey ceramic stone table top ESTPRD\_\_LN  
with dove grey ceramic stone top ESTPRD\_\_LG

 → 65  → 8

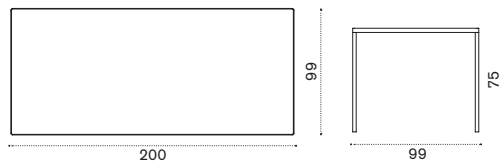

## Rectangular dining table 200x99

with pickled teak table top ESTPRD\_\_T5

 → 54  → 8

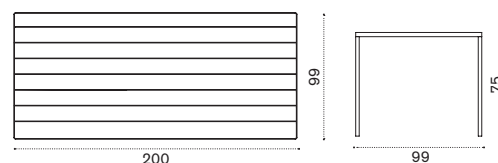

## Oval dining table 240x112,4

with pickled teak top ESTPOD\_\_T5

 → 55  → 8

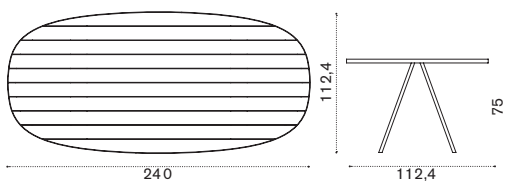

## Sun lounger

sun lounger ESLEWNFD43T5  
mattress nature white ESCULEAW25

 → 44  

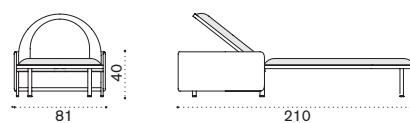

244

Ethimo

# Esedra





# Concreto

Luca Nichetto  
Collection composed of: dining table  
/ high table.



## Material - Base



Concrete

## Material - Pole/Frame



Aluminium  
Warmwhite



Aluminium  
Dark Grey

## Material - Table top



Laminate  
Intense Black



Natural Teak



Pickled Teak

## Rain cover



Ethi-Care

## Dining table Ø 60 h 74

CNTPTM1H1D\_\_\_\_\_

→ 33 → 2

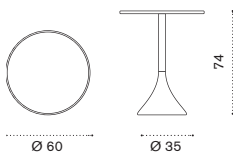

## Dining table Ø 60 h 105

CNTPTM1H2D\_\_\_\_\_

→ 35 → 2

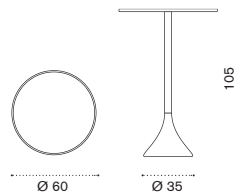

## Dining table Ø 70 h 74

CNTPTM2H1D\_\_\_\_\_

→ 34 → 2

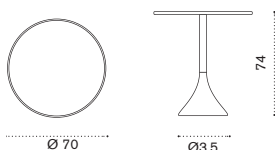

246

## Dining table Ø 70 h 105

CNTPTM2H2D\_\_\_\_\_

→ 36 → 2

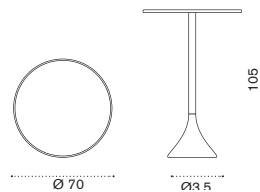

Ethimo

# Concreto



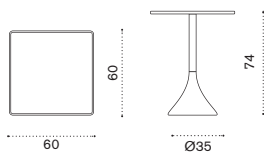

Dining table 60X60 h 74  
CNTPQM1H1D\_\_\_\_\_

 → 33,5   → 2



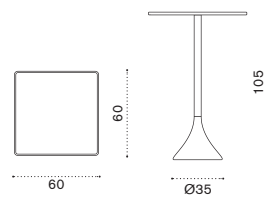

Dining table 60X60 h 105  
CNTPQM1H2D\_\_\_\_\_

 → 35,5   → 2



Dining table 70X70h 74  
CNTPQM2H1D\_\_\_\_\_

 → 34,5   → 2-4

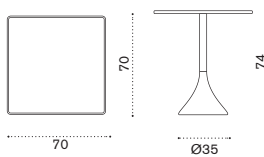



# Kilt

Marcello Ziliani  
 Collection composed of: teak dining  
 armchair / stainless steel dining armchair  
 / 2 seater sofa / lounge armchair  
 / coffee table / dining table.



## Material



## Material



## Material

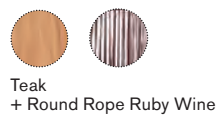

## Rain cover



## Dining armchair

stainless steel + round rope grey KIPDS00RCG

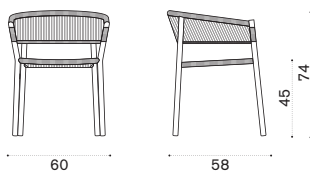

## Dining armchair

teak + round rope sand KIPDT1RCS  
 teak + round rope olive green KIPDT1R56  
 teak + round rope ruby wine KIPDT1R52  
 pickled teak + round rope dark grey KIPDT5RCD

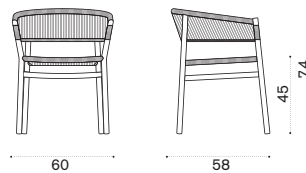
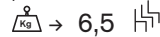

## Square dining table 91x91

teak KITPQT1  
 pickled teak KITPQT5

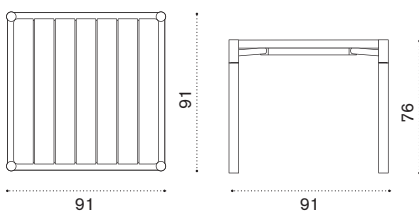

248

## 2 seater sofa

teak + round rope sand KID2T1RCS  
 pickled teak + round rope dark grey KID2T5RCD

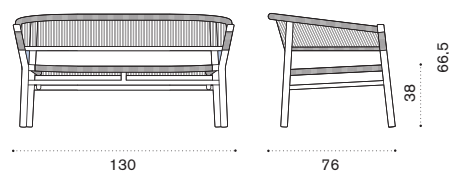
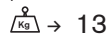

Ethimo

# Kilt

# Pluvia

Luca Nichetto

Collection composed of: natwick dining armchair / round rope dining armchair.



## Material





## Material



## Lounge armchair

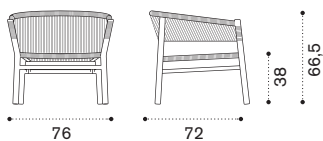

teak + round rope sand KIPLT1RCS  
teak + round rope olive green KIPLT1R56  
teak + round rope ruby wine KIPLT1R52  
pickled teak + round rope dark grey KIPLT5RCD

 → 9 



## Dining armchair

natwick + warmwhite PVPDD43WN  
rope light grey + warmwhite PVPDD43R1  
rope lava grey + dark grey PVPDDGR4

 → 9 

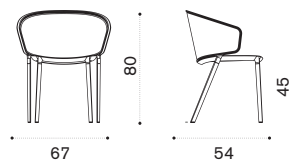

## Square coffee table 65x65

teak KITCQT1  
pickled teak KITCQT5

 → 7

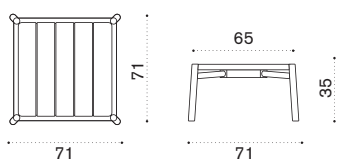



# Ribot

Marc Sadler

Collection composed of: lounge armchair / footstool / coffee table / rectangular extendable table / dining armchair / dining chair / counter stool / barstool.



## Material



Natural Teak



Stainless Steel

## Fabrics



Acrylic Nature Grey



Acrylic Nature White



Acrylic Espresso

## Fabrics



Acrylic Red Navajo



Acrylic Yellow Apache

## Rain cover



Ethi-Care

## Lounge armchair

RBPLT1

cushion RBCUPLA\_

→ 9



## Square coffee table 50x50

RBTCQT1

→ 6

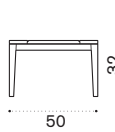
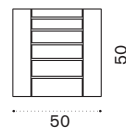

## Footstool

RBFST1

cushion RBCUFSA\_

→ 4

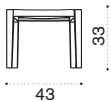

250

## Rectangular extendable dining table 235-340x100

RBTPRM1T1

→ 90 → 8-12

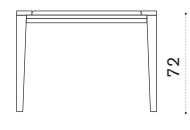
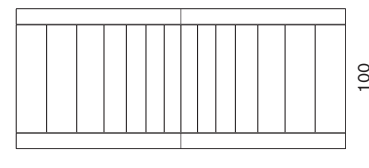

Ethimo

# Ribot



**Dining armchair**  
RBPDT1  
cushion RBCUSEA\_\_\_

$\rightarrow 7,5$

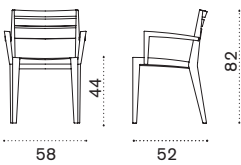

**Dining chair**  
RBSET1  
cushion RBCUSEA\_\_\_

$\rightarrow 6,5$

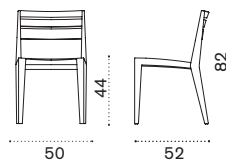

**Counter stool h82**  
RBSGH1T1  
cushion RBCUSGA\_\_\_

$\rightarrow 8,5$

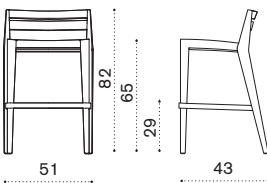

**Barstool h92**  
RBSGH2T1  
cushion RBCUSGA\_\_\_

$\rightarrow 9$

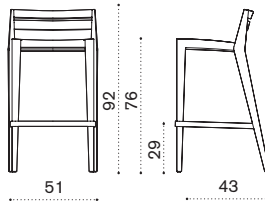



# Agave

Mattia Albicini

Collection composed of: lounge chair  
/ round, square coffee table / dining chair  
/ square, round, rectangular dining table.



## Material - Frame



Metal  
Sepia Black



Natural  
Teak

## Fabrics



Acrylic  
Black Stone



Acrylic  
Velvet Blue



Acrylic  
Velvet Artic Grey

## Fabrics



PP  
Geometric  
Terra



PP  
Geometric  
Marine

## Rain cover



Ethi-Care

## Lounge chair

AGPLB48T1

→ 8

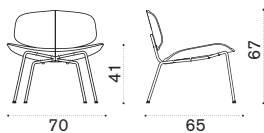

## Shaped seat cushion

black stone AGCUPLSAW28  
velvet blue AGCUPLSA30  
velvet artic grey AGCUPLSA34  
geometric terra AGCUPLSPP35  
geometric marine AGCUPLSPP36

→ 0,5

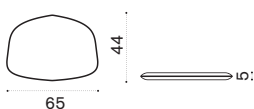

252

## Round seat cushion

velvet blue AGCUPLTA30  
velvet artic grey AGCUPLTA34  
geometric terra AGCUPLTPP35  
geometric marine AGCUPLTPP36

→ 0,5

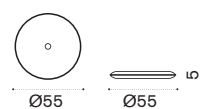

Ethimo

# Agave

## Round coffee table Ø 110

AGTCTB48T1

 → 20

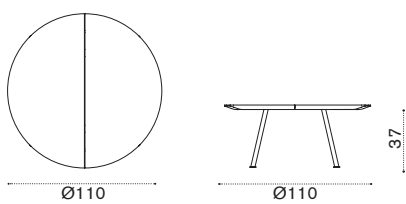

## Square coffee table 65x65

AGTCQB48T1

 → 9

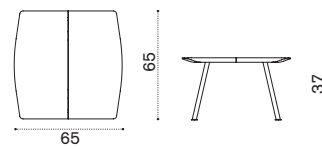

## Dining chair

AGSEB48T1

 → 6

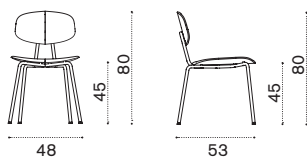

## Shaped seat cushion

black stone AGCUSESASW28  
geometric terra AGCUSESPP35  
geometric marine AGCUSESPP36

 → 0,2

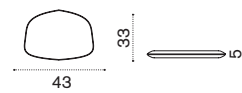

## Round dining table Ø 110

AGTPTB48T1

 → 25   → 5

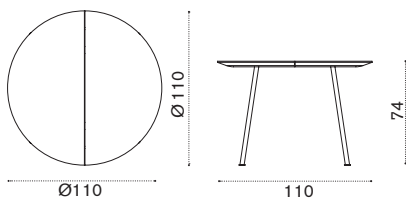

## Square dining table 90x90

AGTPQB48T1

 → 23   → 4

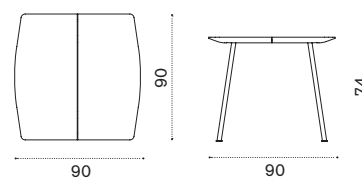

## Rectangular dining table 200x100

AGTPRB48T1

 → 45   → 8

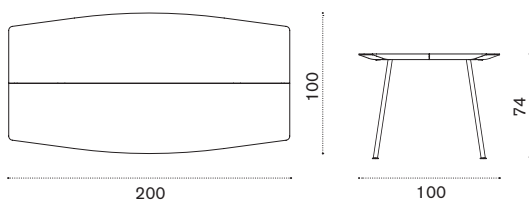



# Costes

Collection composed of: 3 seater sofa / lounge armchair / modular sofa / coffee table / dining armchair / dining table / sun lounger.



## Material



## Fabrics



## Fabrics



## Rain cover



## 3 seater sofa

teak COD3T1  
pickled teak COD3T5  
cushions, seat+2 back COCUD3A\_\_\_\_  
📐 → 48

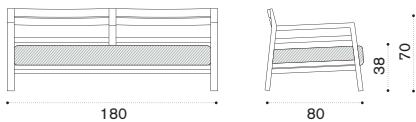

## Lounge armchair

teak COPLT1  
pickled teak COPLT5  
cushions, seat+back COCUPLA\_\_\_\_  
📐 → 34

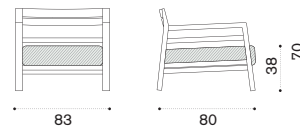

## Central module

teak CODMCT1  
pickled teak CODMCT5  
cushions, seat+back COCUDMCA\_\_\_\_  
📐 → 36

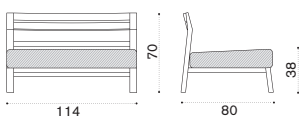

254

## Corner module

teak CODMAUT1  
pickled teak CODMAUT5  
cushions, seat+back COCUDMAUA\_\_\_\_  
📐 → 58

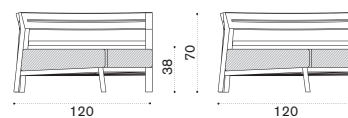



Ethimo

# Costes

## Back end module right (D) / left (S)

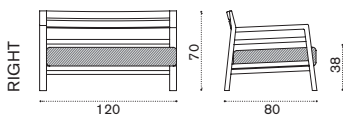

teak CODMF\_T1  
pickled teak CODMF\_T5  
cushions, seat+back COCUDMFA\_

 → 39 



## Coffee table 100x60

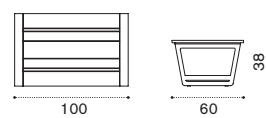

teak COTCRM1T1  
pickled teak COTCRM1T5

 → 11 



## XL coffee table 120x80

teak COTCRM2T1  
pickled teak COTCRM2T5

 → 20 

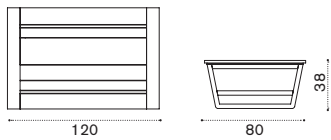

## Dining armchair

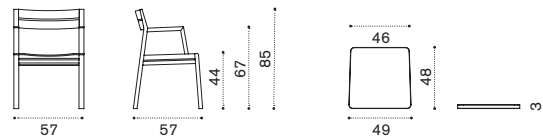

teak COPDT1  
pickled teak COPDT5

 → 10



## Cushion

cushion COCUPDA\_

 → 1 

## Round dining table Ø 175

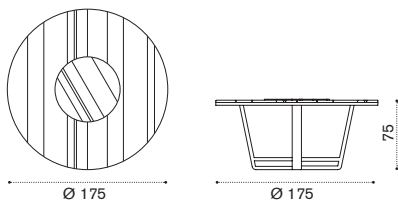

teak COTPTM1T1  
pickled teak COTPTM1T5

 → 94,5   → 8 - 10



## Rectangular dining table 240x160

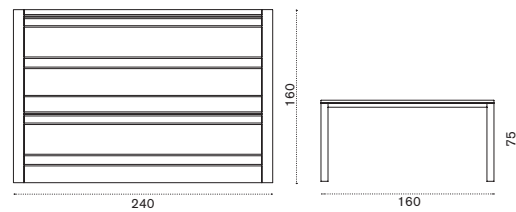

teak COTPRM1T1  
pickled teak COTPRM1T5

 → 105   → 10 - 12



## XL rectangular dining table 300x110



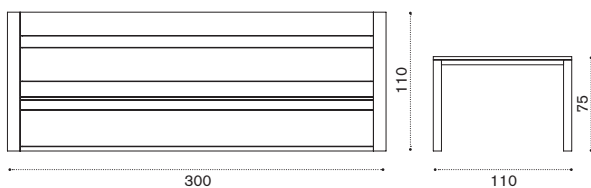

teak COTPRM2T1  
pickled teak COTPRM2T5

 → 108   → 12



## Sun lounger

teak COLET1  
pickled teak COLET5  
mattress COCULEA\_

 → 22   

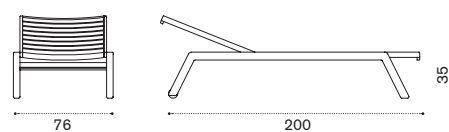



# Play

Collection composed of: square dining table / xl square dining table / rectangular dining table / xl rectangular dining table / ping pong table.



## Material - Base



Aluminium Warmwhite



Aluminium Warmgrey



Aluminium Olive Green

## Material - Table top



Aluminium Warmwhite



Aluminium Warmgrey



Natural Teak



Ceramic Stone Graphite

## Material - Table top



Ceramic Stone Ice White



Ceramic Stone Disegno



Ceramic Stone Piombo Silk

## Rain cover



Ethi-Care

## Square dining table 99x99

aluminium PLTQM1D4\_  
aluminium + ceramic stone PLTQM1D\_\_L\_

→ 33-34 → 4

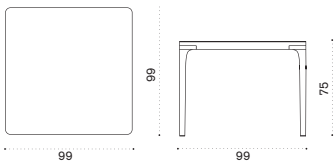

## Square dining table 99x99

aluminium + teak PLTQM1D4\_T1

→ 29 → 4

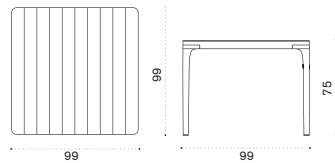

## XL square dining table 149x149

aluminium + ceramic stone table top Disegno PLTPQM2D4\_LL

→ 54 → 8

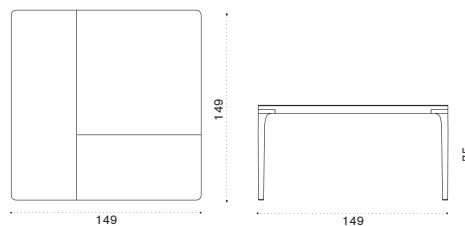

# Play

## XL square dining table 149x149

aluminium PLTPQM2D4\_  
aluminium + ceramic stone PLTPQM2D\_\_L\_

 → 52-54  → 8

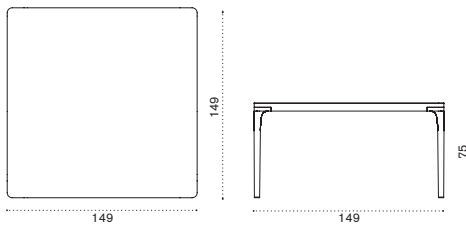

## XL square dining table 149x149

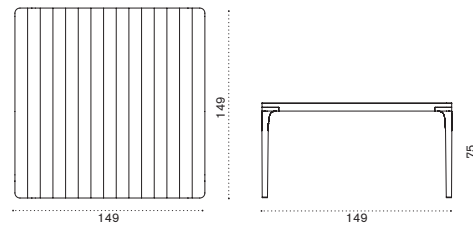

aluminium + teak PLTPQM2D4\_T1

 → 44  → 8



## Rectangular dining table 199x99

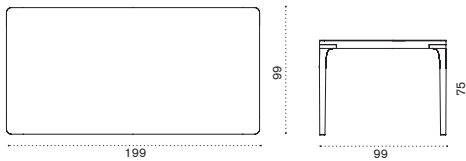

aluminium PLTPRM1D4\_  
aluminium + ceramic stone PLTPRM1D4\_L\_

 → 48-50  → 8



## Rectangular dining table 199x99

aluminium + teak PLTPRM1D4\_T1

 → 40  → 8

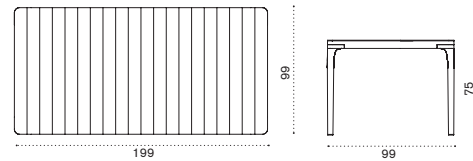

## XL rectangular dining table 274x99

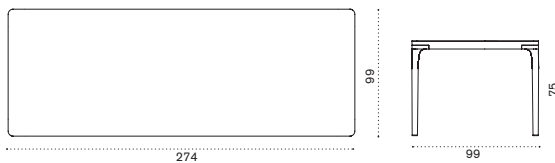

aluminium PLTPRM2D4\_  
aluminium + ceramic stone PLTPRM2D4\_L\_

 → 60-63  → 10



## XL rectangular dining table 274x99

aluminium + teak PLTPRM2D4\_T1

 → 49,2  → 10

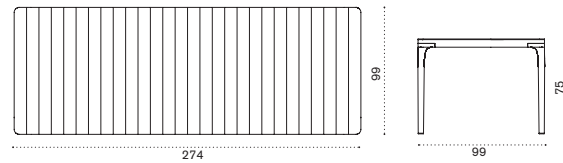

## Rectangular dining / Ping pong table 274x152,5

aluminium + ceramic stone PLTPRM3D38LP kit ping pong included

 → 96,5  → 12

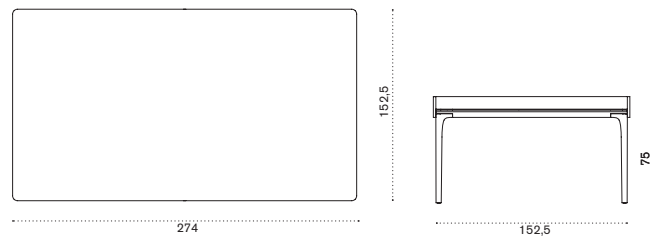



# Enjoy

Collection composed of: dining table / lounge dining table / high table / coffee table.



## Material - Base



Metal Warmwhite



Metal Warmgrey



Ceramic Stone White



Ceramic Stone Black Vulcano



Metal Sepia Black



Metal Coffee Brown



Ceramic Stone Grey

## Cover base



Natural Teak



Pickled Teak

## Rain cover



Ethi-Care

### Coffee table 70x70 h 29

EJTQH1B\_\_\_\_\_

→ 23,5

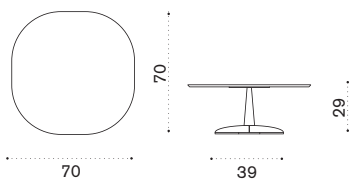

### Coffee table 70x70 h 51

EJTQH2B\_\_\_\_\_

→ 24

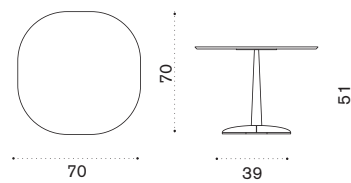

### Lounge dining table 70x70 h 61

EJTQH3B\_\_\_\_\_

→ 24 → 2

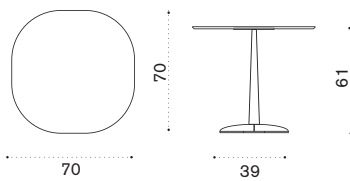

258

### Dining table 70x70 h 75

EJTQH4B\_\_\_\_\_

→ 25 → 2-4

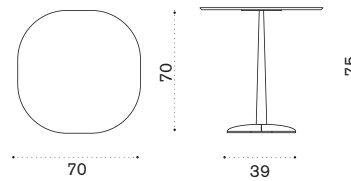

Ethimo

# Enjoy

## High table 70x70 h 106

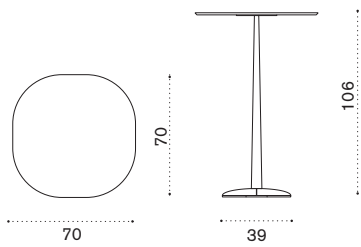

EJTOH5B

 → 28   → 2-4



## Coffee table 70x90 h 29

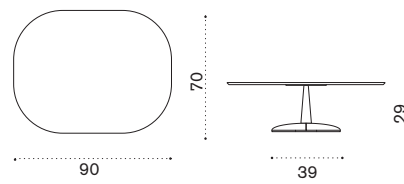

EJTRH1B

 → 27,5 



## Coffee table 70x90 h 51

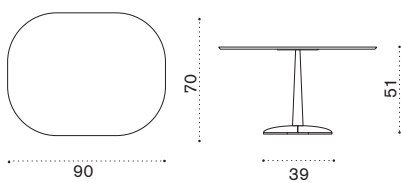

EJTRH2B

 → 28 



## Lounge dining table 70x90 h 61

EJTRH3B

 → 28   → 2

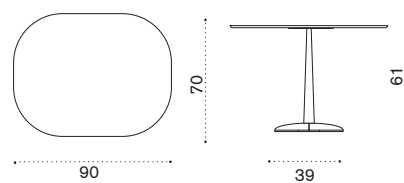

## Dining table 70x90 h 75

EJTRH4B

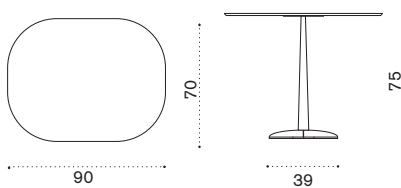

 → 29   → 2-4



## Complementary base cover

teak EJBST1

pickled teak EJBST5

 → 3 

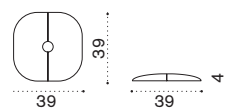



# Nicolette

Patrick Norguet  
Collection composed of: dining armchair  
/ barstool.



## Material



Aluminium  
Warmwhite



Aluminium  
Warmgrey



Aluminium  
Dark Grey



Aluminium  
Sepia Black

## Material



Aluminium  
Coffee Brown



Aluminium  
Olive Green



Aluminium  
Warmred



Natural Teak

## Fabrics



Acrylic  
Nature White



Acrylic  
Nature Grey



Acrylic  
Black Stone

## Rain cover



Ethi-Care

## Dining armchair

NIPDD\_\_T1

$\rightarrow$  8,5



## Barstool

NISGD\_\_T1

$\rightarrow$  11



## Accessories

soft back NICUPDSBAW\_\_  
seat cushion NICUPDAW\_\_

$\rightarrow$  0,5



260

## Accessories

soft back NICUPDSBAW\_\_  
seat cushion NICUPDAW\_\_

$\rightarrow$  0,5

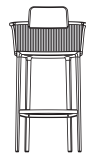

Ethimo





# Infinity

Collection composed of: 3 seater sofa / lounge armchair / coffee table / modular sofa / daybed / pouf / sun lounger.



## Material



## Material

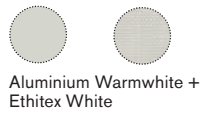

## Fabrics



## Rain cover



## 3 seater sofa

IFD3D4\_W2\_  
cushions, seat+back IFCUD3AW2\_  
Kg → 49

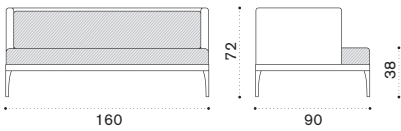

## Lounge armchair

IFPLD4\_W2\_  
cushions, seat+back IFCUPLAW2\_  
Kg → 30

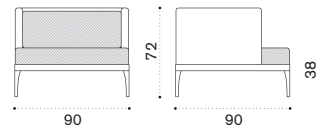

## Square coffee table 90x90

IFTCQD4\_  
Kg → 15

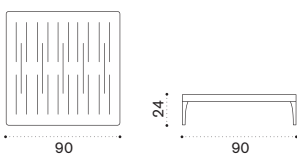

262

## Rectangular coffee table 120x90

IFTCRD4\_  
Kg → 18

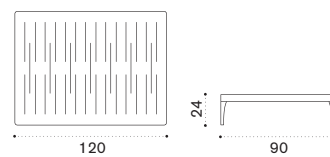



Ethimo

# Infinity

## Central module

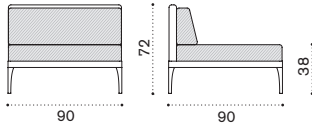

IFDMCM1D4\_W2\_  
cushions, seat+back IFCUDMCM1AW2\_

 → 25 



## Corner module

IFDMAUD4\_W2\_  
cushions, seat+back IFCUDMAUAW2\_

 → 28 

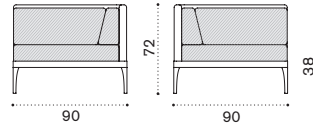

## XL central module

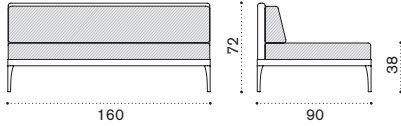

IFDMCM2D4\_W2\_  
cushions, seat+back IFCUDMCM2AW2\_

 → 48 



## XL corner module right (D) / left (S)

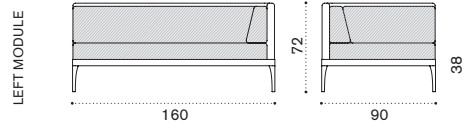

IFDMF\_D4\_W2\_  
cushions, seat+back IFCUDMF\_AW2\_

 → 25 



## Daybed module right (D) / left (S)

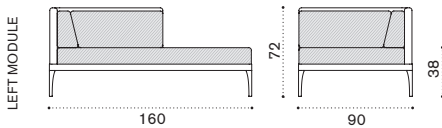

IFDMD\_D4\_W2\_  
cushions, seat+back IFCUDMD\_AW2\_

 → 47 



## Pouf

IFPUD4\_W2\_  
cushion IFCUPUAW2\_

 → 14 

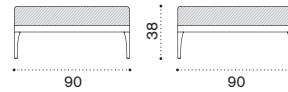

## Sun lounger

aluminium + lightwick IFLED4\_W2\_  
mattress IFCULEAW2\_

 → 17  

aluminium + ethitex IFLED4\_E5\_

 → 13  

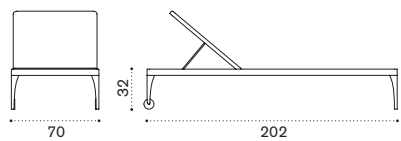

## Smart – side table 43x35

SMTGRD\_

 → 3,5

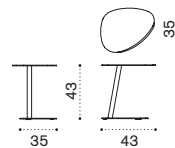



# Ocean

Collection composed of:  
sun lounger.



## Material



Aluminium Warmwhite +  
Ethitex White



Aluminium Warmgrey +  
Ethitex Dove Grey

## Fabrics



Acrylic  
Nature Grey



Rain cover  
Ethi-Care

## Sun lounger

OCLED4\_\_\_  
mattress nature grey OCCULEAW24

→ 17

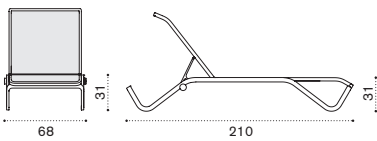

# Smart

Collection composed of:  
side table.



## Material



Aluminium  
Warmwhite



Aluminium  
Warmgrey



Aluminium  
White



Aluminium  
Mud Grey

## Smart side table 43x35

SMTCRD\_\_

→ 3,5

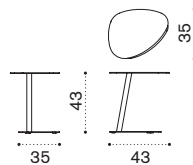

# Essenza

Collection composed of:  
sun lounger / double  
canopy sun lounger.



## Material

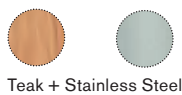

## Fabrics



## Lounge bed with curtains

Curtains included EZALT1S00T1  
mattresses EZCUALA\_\_

→ 91

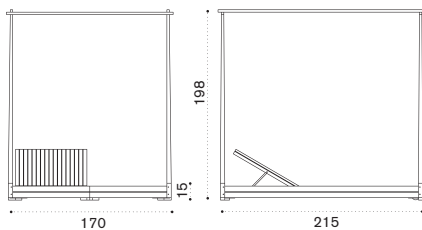

## Sun lounger

EZLES00T1  
mattress EZCULEA\_\_

→ 37

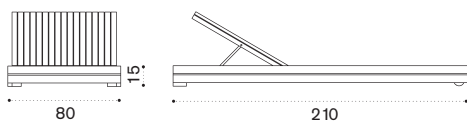

# Friends

Collection composed of:  
square dining table  
/ rectangular dining table.



## Material



## Rain cover



## Square dining table 90x90

teak FDTPQT1  
pickled teak FDTPQT5

→ 10 → 4

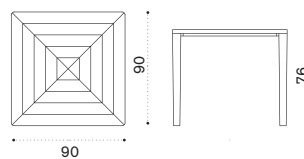

## Rectangular dining table 180x90

teak FDTPT1  
pickled teak FDTPT5

→ 29 → 6-8

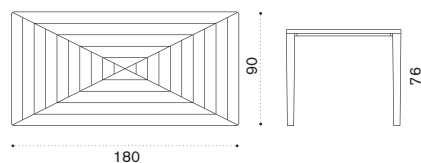

Technical info

265



# Cronos

Collection composed of: round dining table / square dining table / rectangular extendable dining table.



## Material



Pickled Teak



Natural Teak

## Rain cover



Ethi-Care

## Round dining table Ø 147

teak CSTPTT1

pickled teak CSTPTT5

→ 61,5 → 6-8

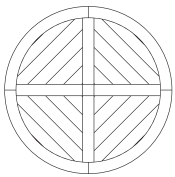

Ø 147

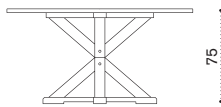

75

## Square dining table 140x140

teak CSTPQT1

→ 56 → 8

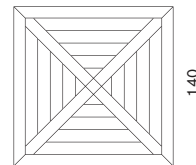

140

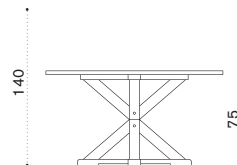

75

## Extendable rectangular dining table 220-260-300x100

teak CSTPRT1

pickled teak CSTPRT5

→ 100 → 8-12

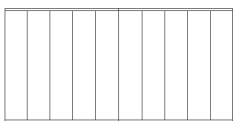

220-260-300

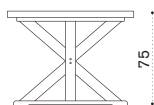

75

100

266

Ethimo

# Elit

Collection composed of:  
sunbed.



# Elle

Collection composed of:  
deck chair.



## Material



Pickled Teak



Natural Teak



Acrylic Ivory



Acrylic Dove Grey



Acrylic Cherry Red



Acrylic Narval Blue

## Fabrics



Ethitex White



Ethitex Lilac



Ethitex Dove Grey



Ethitex Blue

## Fabrics



Ethitex Red

## Sunbed

teak + fabric ETBRT1\_\_\_  
pickled teak + fabric ETBRT5A\_\_\_

→ 13,5

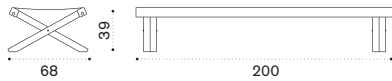

## Deck chair

teak + fabric ELSRT1\_\_\_  
pickled teak + fabric ELSRT5A\_

→ 7

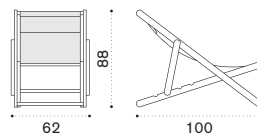



# Notting Hill

Collection composed of: bench / armchair.



## Material



Pickled Teak



Natural Teak



Mahogany Ostuni White



Mahogany Pantelleria Blue



Mahogany Langhe Green



Mahogany Lipari Grey

## Material

## Fabrics



Acrylic Ivory



Acrylic Cherry Red



Acrylic Espresso



Acrylic Black Stone

## Rain cover



Ethi-Care

## Armchair

pickled teak NHPOT5  
teak NHPOT1  
mahogany NHPOM\_  
classic cushion NHCUPOA\_

→ 12,5

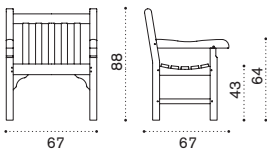

## Bench

pickled teak NHPAT5  
teak NHPAT1  
mahogany NHPAM\_  
classic cushion NHCUPAA\_

→ 21

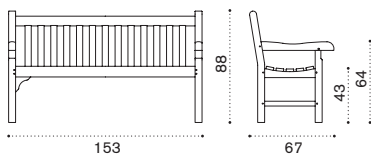

268

Ethimo

# Sand / Sandy

Collection composed of:  
 Sand – sunbed.  
 Sandy – backrest with mattress.



## Material



Natural Teak

## Material



Natural Teak + Ethitex White



Natural Teak + Ethitex Dove Grey

## Fabrics



Acrylic Nature White



Acrylic Nature Grey



Acrylic Black Stone



Acrylic Cherry Red



Acrylic Narval Blue

## Rain cover



Ethi-Care

## Sand Teak

SDLET1

mattress SDCULEA

kg → 25



## Sand Teak + ethitex

SDLET1E5\_

kg → 20,5

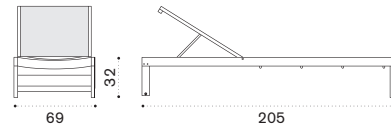
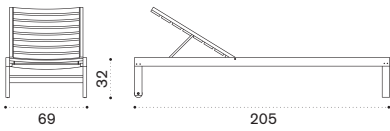

## Sandy Backrest

teak SYSH1

mattress ethitex SYCUSHE52

kg → 7

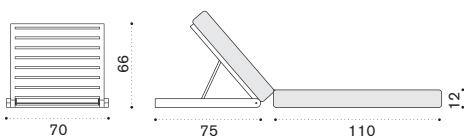



# T-Box

Collection composed of:  
trunk.



## Material



Pickled  
Teak



Natural  
Teak

## T-Box Trunk

pickled teak TBBLT5  
teak TBBLT1

→ 50

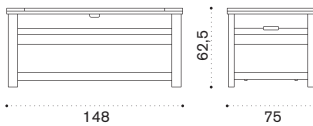

## Clay Square coffee table 45x45

pickled teak CYTCQT5  
teak CYTCQT1

→ 7

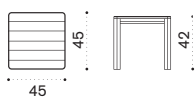

270

# Clay / Petit club

Collection composed of:  
coffee table



## Material



Pickled  
Teak



Natural  
Teak

## Petit club Square coffee table

54x54 with removable tray

pickled teak PCTCQT5  
teak PCTCQT1

→ 8,5

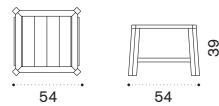

## Petit club Rectangular coffee table

84x54 with removable tray

pickled teak PCTCRT5  
teak PCTCRT1

→ 10

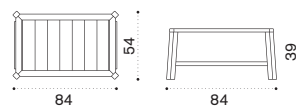

Ethimo

# Cruise

Collection composed of: deck chair.



## Material



Pickled  
Teak



Natural  
Teak



## Fabrics



Acrylic  
Ivory

## Deck chair

pickled teak CRSDT5  
teak CRSDT1  
mattress CRCUSDA1

 → 16  

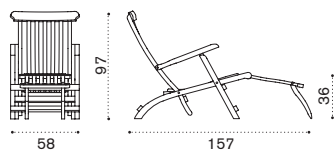



# Elisir

Collection composed of: 2 seater sofa / lounge armchair / coffee table / dining armchair / dining chair / round, square and rectangular extendable dining table / sunbed.



## Material



Metal White



Metal Mud Grey



Metal Coffee Brown

## Fabrics



Acrylic Nature White



Ethitex White



Acrylic Nature Grey



Ethitex Dove Grey

## Fabrics



Acrylic Ivory

## Rain cover



Ethi-Care

## 2 seater sofa

EID2S\_\_  
cushions, seat+2 back EICUD2AW2\_

→ 33,5

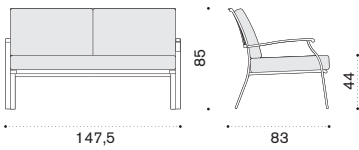

## Lounge armchair

EIPLS\_\_  
cushions, seat+back EICUPLAW2\_

→ 18,8

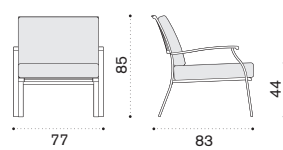

## Square coffee table 80x80

EITCQB\_\_

→ 15,5

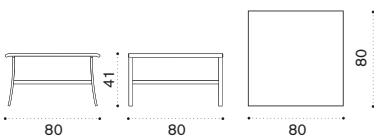

## Round dining table Ø 110

EITPTB\_\_

→ 21,5 → 5

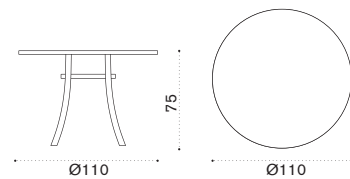

272

Ethimo

# Elisir

## Square dining table 70x70 – 80x80 – 90x90

70x70 EITPQM1B\_\_  
80x80 EITPQM2B\_\_  
90x90 EITPQM3B\_\_

→ 12 - 14 - 17 → 2-4

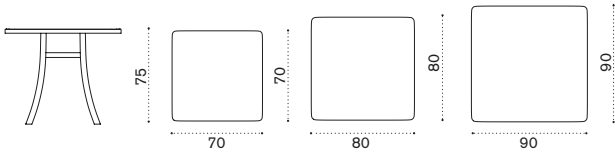

## Extendable XL rectangular dining table 200-260x100

EITPRM2B\_\_

→ 85 → 8-10

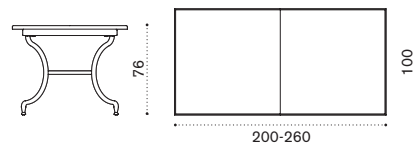

## Extendable rectangular dining table 160-220x90

EITPRM1B\_\_

→ 65 → 6-8

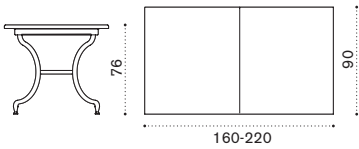

## Dining chair

EISEB\_\_

Classic seat cushion (H 3cm) EICUSEPDAW2\_

Pratic seat cushion (H 2cm) CUSEPREIA1

→ 7

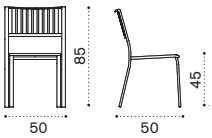

## Dining armchair

EIPDB\_\_

Classic seat cushion (H 3cm) EICUSEPDAW2\_

Pratic seat cushion (H 2cm) CUSEPREIA1

→ 8,5

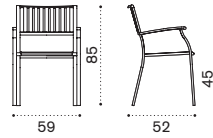

## Sunbed

Metal white + white ethitex EILEB31E57

Metal mud grey + dove grey ethitex EILEB40E52

→ 17

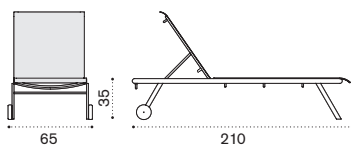

## Smart – side table 43x35

SMTGRD\_\_

→ 3,5

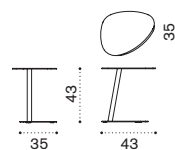



# Laren

Collection composed of: folding chair / stacking chair / stacking armchair / round, square and rectangular dining table / barstool / high table.



## Material



Metal Mud Grey +  
Pickled Teak

## Material



Metal Coffee Brown +  
Natural Teak

## Rain cover



Ethi-Care

## Folding chair

pickled teak LASPB40T5  
teak LASPB51T1

→ 6 →

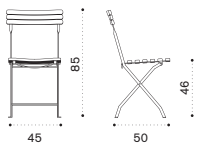

## Dining chair

pickled teak LASEB40T5  
teak LASEB51T1

→ 5

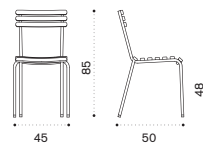

## Dining armchair

pickled teak LAPDB40T5  
teak LAPDB51T1

→ 6

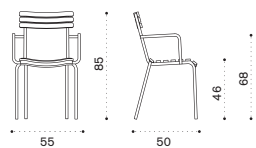

## Round dining table Ø 60

pickled teak LATPTH1B40T5  
teak LATPTH1B51T1

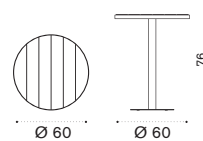

→ 12,5 → 2



# Laren

## Square dining table 70x70

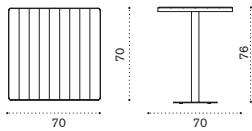

pickled teak LATPQM1H1B40T5  
teak LATPQM1H1B51T1

 → 15,5  → 4



## Square dining table 90x90

pickled teak LATPQM2B40T5  
teak LATPQM2B51T1

 → 25  → 4

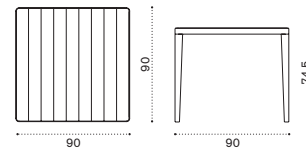

## Rectangular dining table 160x90

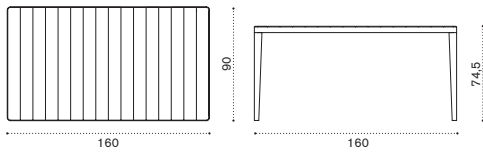

pickled teak LATPRM2B40T5  
teak LATPRM2B51T1

 → 36  → 6-8



## Barstool

pickled teak LASGB40T5  
teak LASGB51T1

 → 6 

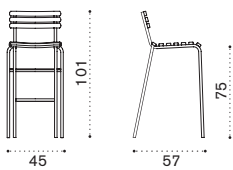

## High rectangular table 120x60

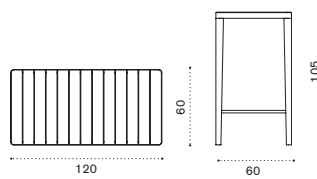

pickled teak LATPRM1B40T5  
teak LATPRM1B51T1

 → 31  → 4-6



## High round table Ø 60

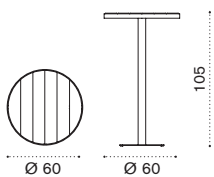

pickled teak LATPTH2B40T5  
teak LATPTH2B51T1

 → 17,5  → 2



## High square dining table 70x70

pickled teak LATPQM1H2B40T5  
teak LATPQM1H2B51T1

 → 20,5  → 4

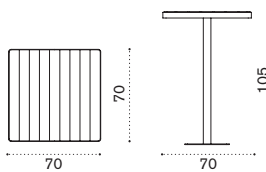



# Flower

Collection composed of: folding chair / stacking chair / stacking armchair / round, square and rectangular dining table / high table / barstool.



## Material

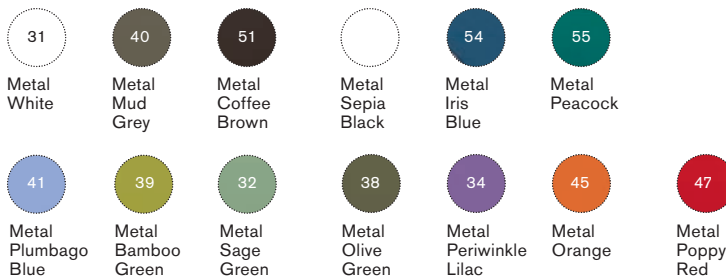

## Fabrics



## Folding chair

FLSPB\_\_

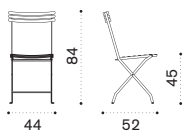
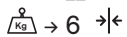

## Dining chair

FLSEB\_\_

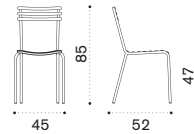
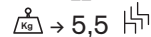

## Dining armchair

FLPDB\_\_

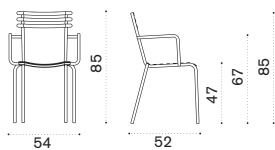
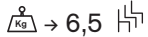

276

## Seat cushion

CUSEPRFLA1

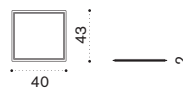
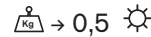

Ethimo

# Flower

Round folding table Ø 60

FLTPM1B\_\_

→ 7 → 2

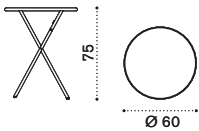

Rectangular folding table 55x70

FLTPRM1B\_\_

→ 9 → 2

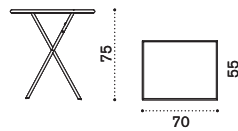

Square folding table 80x80

FLTPQM2B\_\_

→ 13 → 4

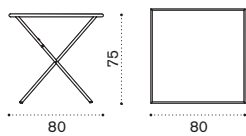

Round folding table ø 105

FLTPM2B\_\_

→ 16,5 → 5

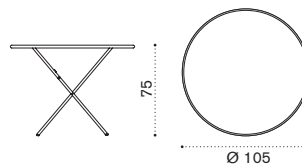

Rectangular folding table 80x160

FLTPRM2B\_\_

→ 26 → 6

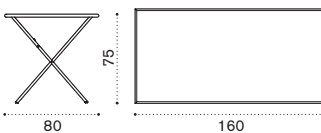

Square dining table 70x70

FLTPQM1H1B\_\_

→ 18 → 2-4

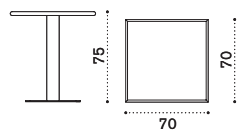

High square dining table 70x70

FLTPQM1H2B\_\_

→ 23 → 2-4

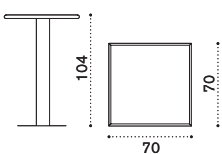

Barstool

FLSGB\_\_

→ 7

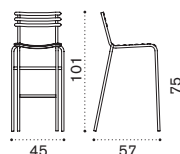



# Cube

Collection composed of: 3 seater sofa / lounge armchair / pouf / modular sofa / footstool / coffee table / double and single sunbed.



## Material



Etwick  
Bark



Etwick  
White

## Fabrics



Acrylic  
Ivory



Acrylic  
Dove Grey

## Rain cover



Ethi-Care

## 3 seater sofa

CBD3W2\_  
cushions, seat+2 back CBCUD3A\_\_

→ 41,5

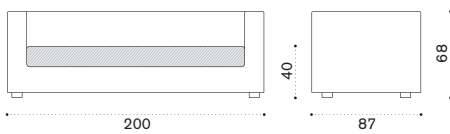

## Lounge armchair

CBPOW2\_  
cushions, seat+back CBCUPOA\_\_

→ 24,5

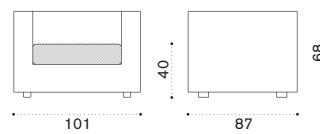

## Pouf

CBPUW2\_  
cushion, seat CBCUPUA\_\_

→ 9

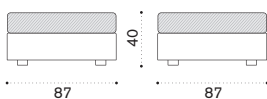

278

## Corner module

CBDMAUW2\_  
cushions, seat+back CBCUDMAUA\_\_

→ 23,5

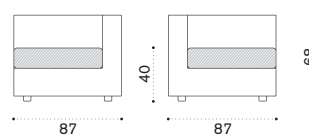

Ethimo

# Cube

## Central module

CBDMCW2\_  
cushions, seat+back CBCUDMCA\_\_  
Kg → 19 

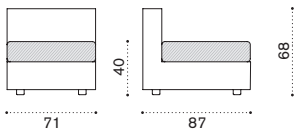

## Footstool

CBFSW2\_  
Kg → 5,2 

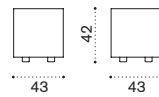

## Square coffee table 87x87

with glass CBTCQW2\_  
Kg → 17,5 

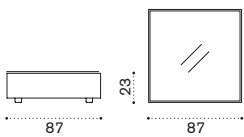

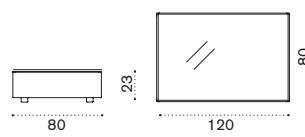

## Rectangular coffee table 120x80

with glass CBTCRW2\_  
Kg → 22 



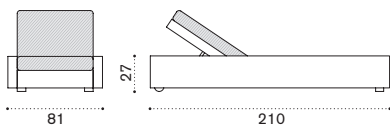

## Sunbed

CBLEW2\_  
mattress CBCULEA\_\_  
Kg → 39,5  



## Double sunbed

CBLDW2\_  
mattress CBCULDA\_\_  
Kg → 68  

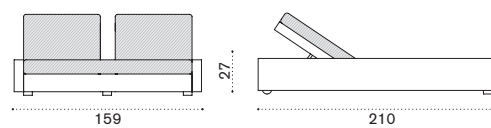



# Phorma

Collection composed of:  
3 seater sofa / lounge  
armchair.



# Loto

Collection composed of:  
coffee table



## Material



Etwick  
Bark



Etwick  
White

## Fabrics



Acrylic  
Ivory



Acrylic  
Dove Grey

## Rain cover



Ethi-Care

### 3 seater sofa

PHD3W2\_  
cushions, seat+2 back PHCUD3A\_\_  
Kg → 51

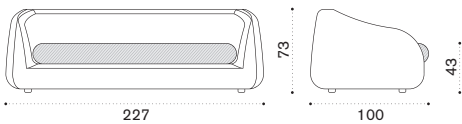

### Rectangular coffee table 65x40

LOTCRW2\_  
Kg → 5,5

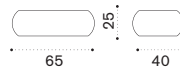

### Lounge armchair

PHPOW2\_  
cushions, seat+back PHCUPOA\_\_  
Kg → 32

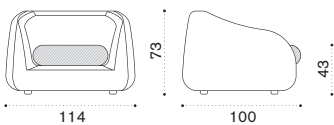

280

### Square coffee table 90x90

LOTQW2\_  
Kg → 10,5

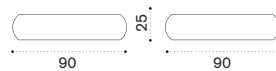

Ethimo

# Holiday

Collection composed of:  
square and rectangular wooden umbrella.



## Material - Pole



Solid  
Oak

## Fabrics



Acrylic  
Ivory



Acrylic  
Dove Grey



Acrylic  
Lilac

## Rain cover



Ethi-Care

## Rectangular umbrella 4x3 m

HOBRFA\_\_

8 concrete tiles SETMA8PZ

umbrella → 90 + tiles → 167

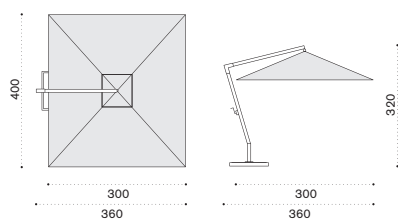

## Square umbrella 3x3 m

HOQBFA\_\_

8 concrete tiles SETMA8PZ

umbrella → 85 + tiles → 167

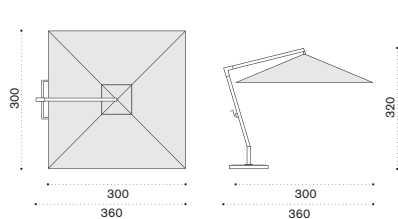



# Classic

Collection composed of: square, round and rectangular wooden umbrella.



## Material - Pole



Solid Oak

## Material - Base



Metal White



Metal Mud Grey

## Fabrics



Acrylic Ivory



Acrylic Dove Grey



Acrylic Leaf



Acrylic Lilac



Acrylic Espresso



Acrylic Avio

## Rain cover



Ethi-Care

## Square umbrella 2,2x2,2 m

CCOMQM2FA\_

19 kg → ☔

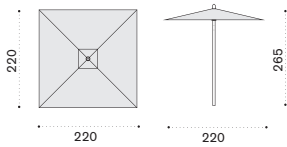

## Square umbrella 3x3 m

CCOMQM1FA\_

21 kg → ☔

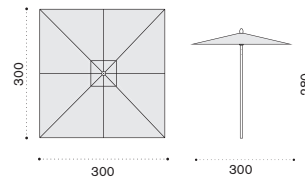

# Classic

## Round umbrella Ø 2,5 m

CCOMTM2FA\_

kg → 19 → ← ☀

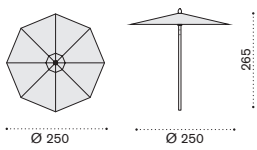

## Round umbrella Ø 3,5 m

CCOMTM1FA\_

kg → 21 → ← ☀

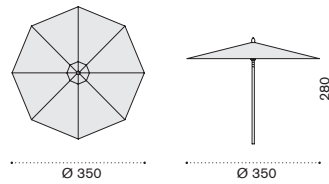

## Rectangular umbrella 4x3 m

CCOMRM1FA\_

kg → 23 → ← ☀

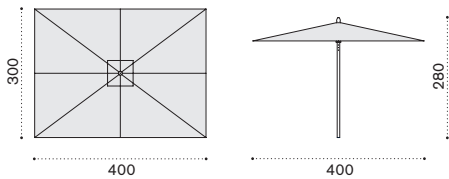

## Base for 3x3 – 4x3 – ø 3,5 m parasols

24 kg base OMBAM21PB\_

48 kg base OMBAM22PB\_

70 kg base OMBAM23PB\_

kg → 24 - 48 - 70 → ←

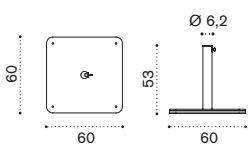

## Base for 2,2x2,2 – ø 2,5 m parasols

23 kg base OMBAM11PB\_

47 kg base OMBAM12PB\_

kg → 23 - 47 → ←

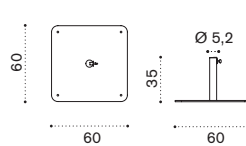



# Freedom

Collection composed of: square adjustable aluminium umbrella.



## Material - Pole



Aluminium

## Fabrics



Acrylic  
Dove Grey



Polyester  
White

## Rain cover



Ethi-Care

## Adjustable square umbrella 3x3 m

FRÖBQD52\_\_

kg → 240 ⚙️ ⚡ ⚙️ ⚡

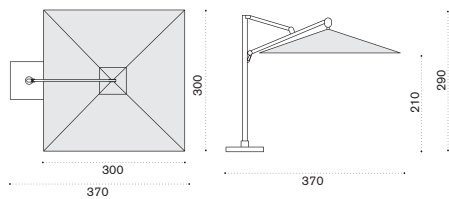

# Free

Collection composed of: square and rectangular aluminium umbrella.



## Material - Pole



Aluminium

## Material - Base



Metal White



Metal Mud Grey

## Fabrics



Polyester Dove Grey



Polyester White



Polyester Red

## Rain cover



Ethi-Care

## Square umbrella 2,2x2,2 m

UMOMQM1P\_

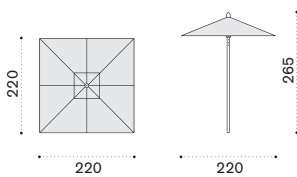
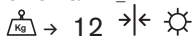

## Rectangular umbrella 3x2 m

UMOMRP\_

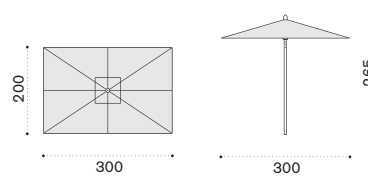
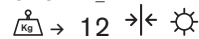

## Square umbrella 3,5x3,5 m

UMOMQM2P\_

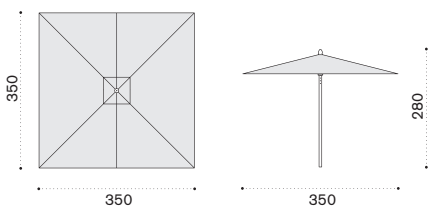
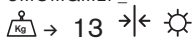

## Base for 2,2x2,2 – 3x2 m parasols

23 kg base OMBAM11PB\_

47 kg base OMBAM12PB\_

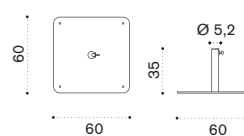
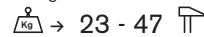

## Base for 3,5x3,5 m parasols

48 kg base OMBAM22PB\_

70 kg base OMBAM23PB\_

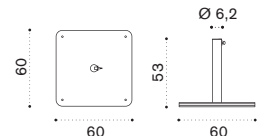
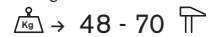

Technical info



# Clostra

Emmanuel Gallina  
Collection composed of: high shield / low shield / planter.

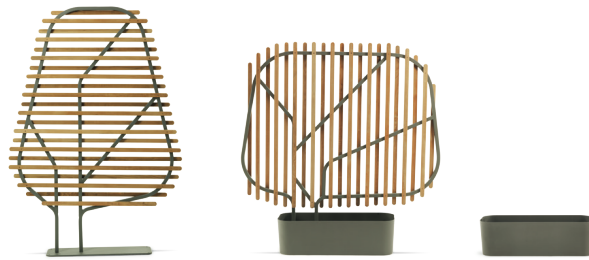

## Material



Shield 123x175  10   
CTSCM1D44T1

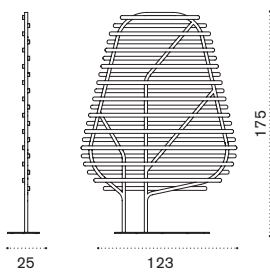

Shield 145x145  10,5   
CTSCM2D44T1

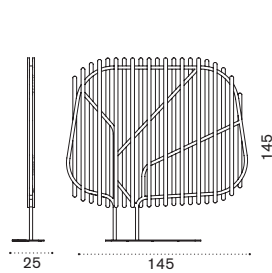

Planter  
CTFIB44

 13

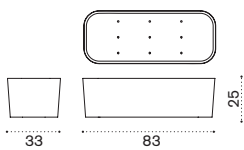

286

Ethimo

# Malindi / Goa / Coimbra / Petra

Collection composed of: outdoor rug.

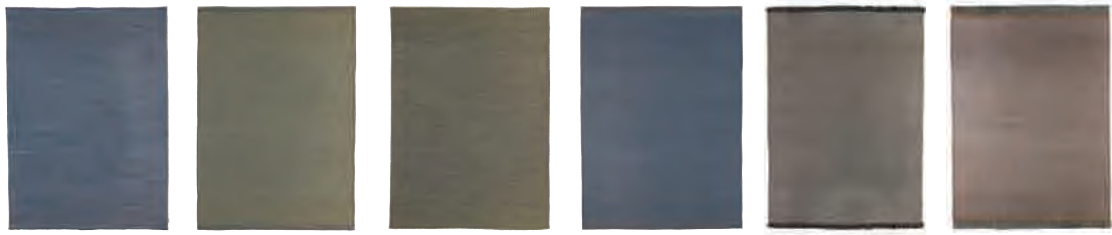

## Material



Malindi  
Blue  
Indigo



Malindi  
Green  
Seaweed



Goa  
Blue  
Indigo



Goa  
Green  
Seaweed



Coimbra  
Coconut



Petra  
Clay / Terracotta

## Malindi

blue indigo MLTAPP81  
green seaweed MLTAPP80

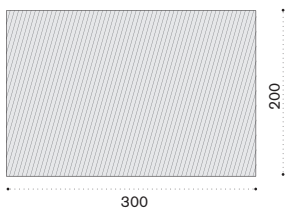
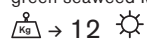

## Goa

blue indigo GOTAPP81  
green seaweed GOTAPP80

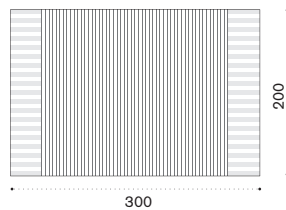
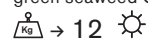

## Coimbra

CMTAPP84

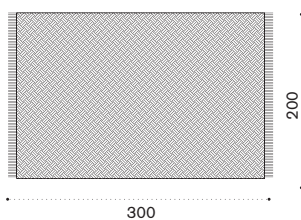
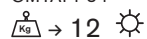

## Petra

PTTAPP83

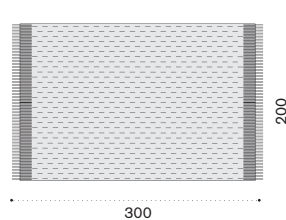
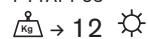

Technical info



# Lucerna

Luca Nichetto  
Collection composed of: rechargeable lantern / wired lantern / lamp holder bracket.



## Material - Lighting fixture



## Material - Blown glass



## Rechargeable lantern

LNLAV\_RD\_\_  
 → 2,5

IP44 LED 6W  
 3000° K - 450 LUMEN  
 N. batteries: 4 X 1,5V / 2600 mA  
 Max endurance with batteries: 8h  
 Recharging cycles 8h  
 ENERGETIC CLASS: A

## Wired lantern

LNLAV\_CD\_\_  
 → 2,5

IP44 LED 230 VAC 6W  
 3000° K - 450 LUMEN  
 ENERGETIC CLASS: A

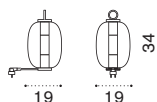
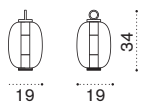

## Lamp holder bracket

LNSPLAD\_\_  
 → 1

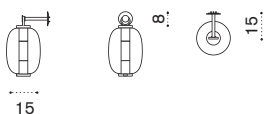

# Pharos

Luca Nichetto  
Collection composed of: lamp post  
/ wall lamp.



## Material



Aluminium  
Dark Grey

## Lamp post H 140

PHLAM2DG

→ 4

IP65 LED 230 VAC 15W  
3000° K - 1500 LUMEN  
ENERGETIC CLASS: A

## Lamp post H 200

PHLAM1DG

→ 4,5

IP65 LED 230 VAC 15W  
3000° K - 1500 LUMEN  
ENERGETIC CLASS: A

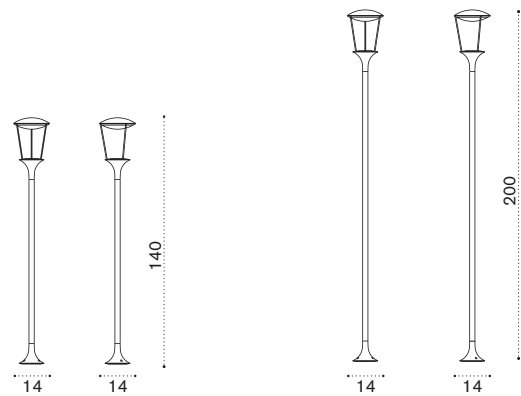

## Wall Lamp

PHLAWDG

→ 4

IP65 LED 230 VAC 15W  
3000° K - 1500 LUMEN  
ENERGETIC CLASS: A

## Base Plate

PHBALDG

→ 9

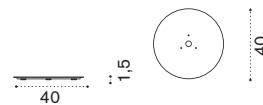
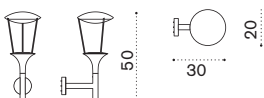



# Milk

Emmanuel Gallina  
Collection composed of:  
portable solar lamp.

# Shake

Emmanuel Gallina  
Collection composed of:  
floor lamp / xl floor lamp.



## Material



Natural Teak + Glass

## Material



Natural Teak + Frosted plexiglass

## Solar lamp

MKLAT1



IP65 50-100 LUMEN  
Rechargeable battery 3.6V 2600 mAh  
Li-ion Max endurance: 8h  
Recharging cycles with line power 10h

## Floor lamp

SKLAM1T1



IP44 2700° K - 1650 LUMEN  
LED 230 Vac 17W  
ENERGETIC CLASS: A

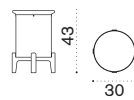
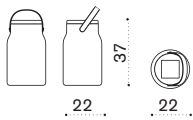

## XL floor lamp

SKLAM2T1



IP44 2700° K - 1650 LUMEN  
LED 230 Vac 17W  
ENERGETIC CLASS: A

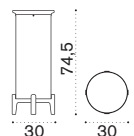

# Step

Niccolò Grassi  
Collection composed of: square path lamp.



---

## Material



Terracotta



Red Earth



Mud Grey

---

## Square path lamp

STLAC\_



IP44 1xGU10 MAX 13W FL 220-240V

ENERGETIC CLASS: E ≥ A++

(Bulb not included, depends on the bulb used)  
according to European regulations

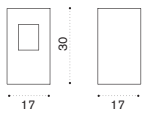



# Carré

Niccolò Grassi  
Collection composed of: wall lamp  
/ table lamp / rechargeable table lamp  
/ bollard / xl floor lamp.



## Material



Metal Sepia Black  
+ Pickled Teak



Metal Warmwhite  
+ Pickled Teak

## Wall lamp

CALAWB4\_T5

→ 3,5

IP44 2700° K - 1650 LUMEN  
LED 230 Vac 17W  
ENERGETIC CLASS: A

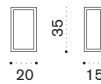

## Table lamp

CALATB4\_T5

→ 9

IP44 2700° K - 1650 LUMEN  
LED 230 Vac 17W  
ENERGETIC CLASS: A

## Rechargeable table lamp

CALATRB4\_T5

→ 9

IP44 3000° K  
LED n. 4 x 4W  
N. batteries: 2 x 12V 2Ah SSL  
Max endurance with batteries: 10h  
Recharging cycle 8h  
ENERGETIC CLASS: A

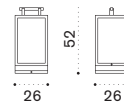
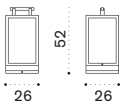

## Bollard

CALAPB4\_T5

→ 5

IP55 2700° K - 1650 LUMEN  
LED 230 Vac 17W  
ENERGETIC CLASS: A

## XL floor lamp

CALAXB4\_T5

→ 11,5

IP44 2700° K - 1650 LUMEN  
LED 230 Vac 17W  
ENERGETIC CLASS: A

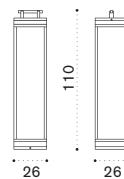
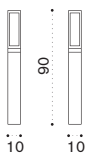

# Ginger

Niccolò Grassi  
Collection composed of: table lamp  
/ xl floor lamp / wall lamp.



---

## Material



Natural Teak + Aluminium

---

## Table lamp

GGLATD52T1

 → 3,5  

IP44 2700° K - 1650 LUMEN  
LED 230 Vac 17W  
ENERGETIC CLASS: A

## XL floor lamp

GGLAXD52T1

 → 9  

IP44 2700° K - 1650 LUMEN  
LED 230 Vac 17W  
ENERGETIC CLASS: A

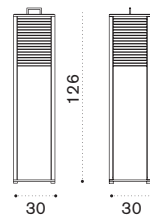
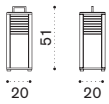

---

## Wall lamp

GGLAWD52T1

 → 3  

IP44 2700° K - 1650 LUMEN  
LED 230 Vac 17W  
ENERGETIC CLASS: A

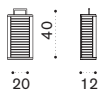





# General information

Headoffice Ethimo Italy  
N° 6 Via La Nova,  
01030 – Vitorchiano VT  
(Italy)

tel +39 0761 300 444  
e-mail [info@ethimo.com](mailto:info@ethimo.com)  
www.ethimo.com

---

Ethimo si riserva di apportare lievi variazioni (misure o dettagli) ai prodotti presentati in catalogo per ragioni migliorative o di adeguamento tecnologico. Il colore dei prodotti presentati nelle immagini potrebbe essere lievemente difforme dalla realtà a causa della resa fotografica e di stampa.

Ethimo reserves the right to make slight variations (dimensions or details) to the products presented in the catalogue due to improvements or technological adaptation. The colour of the product images could be slightly different from reality due to photographic and printing resolution.



ISO 9001 / UNI EN ISO  
9001:2015



The mark of  
responsible forestry  
FSC™ C129240

Ethimo is an FSC™ Forest Stewardship Council™ certified company, guaranteeing the quality of the materials used and respect for nature.  
Certificate SGSCH-COC-090034  
All items are FSC™ certified.



CATAS Member



# Colophon – info

Project coordinator – Ethimo

Art direction – Designwork

Copy – Daniele Varelli

Copyright – Ethimo

Total or partial reproduction of text,  
photos and illustrations is not allowed,  
unless authorized

Photographers – Bernard Touillon, Massimo Gardone / Azimut  
Mauro Mattioli, Frédéric Vasseur

Made and printed – Italy, November 2020

Ethimo – Whitesse srl

Registered office N° 16 Via Brisa, 20123 – Milano (Italy)

Headquarter N° 6 Via La Nova, 01030 – Vitorchiano VT (Italy)

VAT number 04445850961

tel +39 0761 300 444

e-mail [info@ethimo.com](mailto:info@ethimo.com)

www.ethimo.com

Showroom

Milan / Corso Magenta ang. Via Brisa

Rome / 27, Piazza Apollodoro

London / 311, Centre Dome Design Centre, Chelsea Harbour

Paris / 62, Boulevard Malesherbes

Cannes / 98, Boulevard Carnot – Le Cannet

Cortina d'Ampezzo / 27, Via Cesare Battisti

Viterbo / 6a, Via La Nova – Vitorchiano

Köln <sup>NEW</sup> / Design Post – Deutz-Mülheimer-Str. 22a / Opening January 2021

Linear C

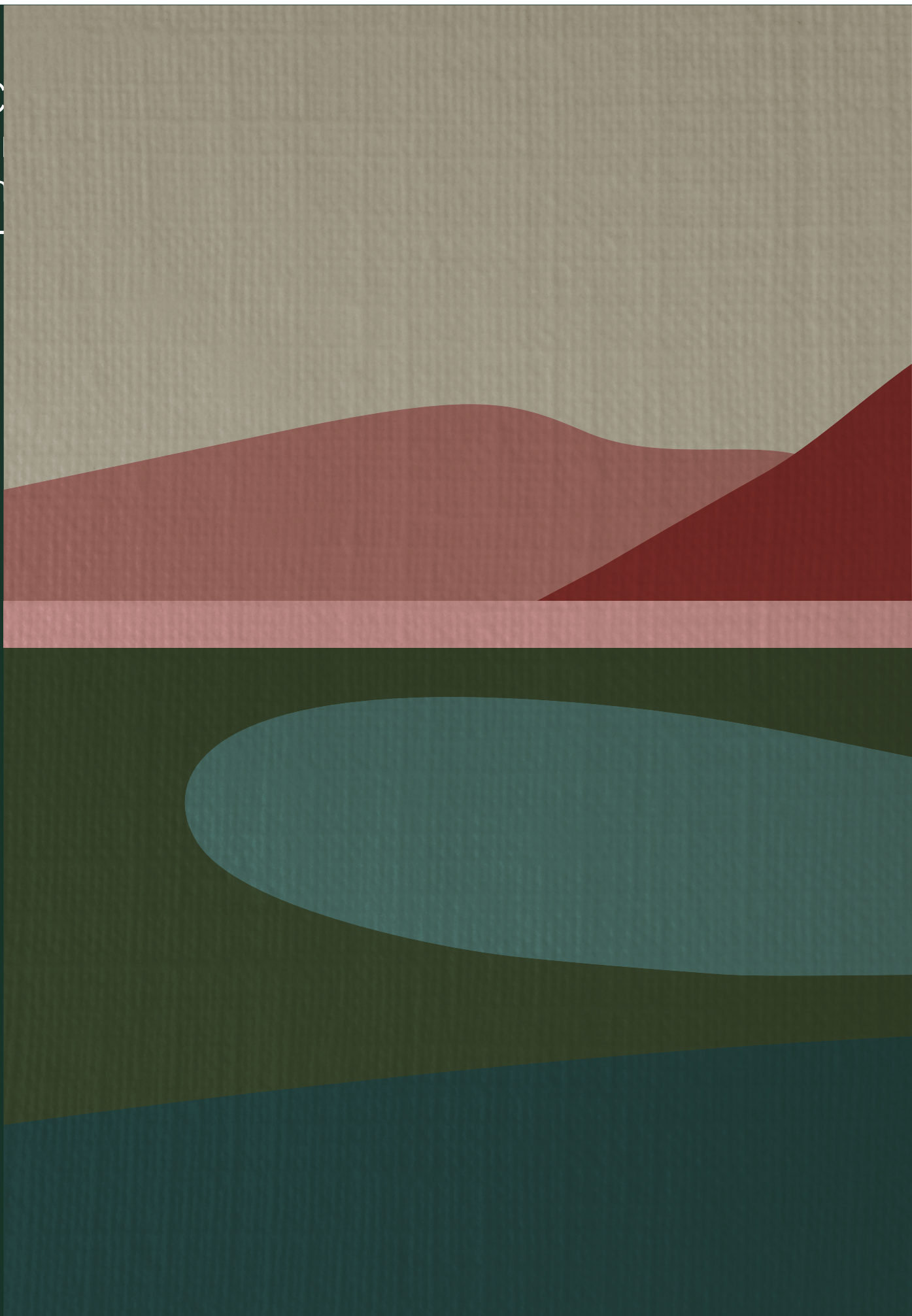



# Colophon – info

Project coordinator – Ethimo

Art direction – Designwork

Copy – Daniele Varelli

Copyright – Ethimo

Total or partial reproduction of text,  
photos and illustrations is not allowed,  
unless authorized

Photographers – Bernard Touillon, Massimo Gardone / Azimut  
Mauro Mattioli, Frédéric Vasseur

Made and printed – Italy, November 2020

Ethimo – Whitesse srl

Registered office N° 16 Via Brisa, 20123 – Milano (Italy)

Headquarter N° 6 Via La Nova, 01030 – Vitorchiano VT (Italy)

VAT number 04445850961

tel +39 0761 300 444

e-mail [info@ethimo.com](mailto:info@ethimo.com)

www.ethimo.com

Showroom

Milan / Corso Magenta ang. Via Brisa

Rome / 27, Piazza Apollodoro

London / 311, Centre Dome Design Centre, Chelsea Harbour

Paris / 62, Boulevard Malesherbes

Cannes / 98, Boulevard Carnot – Le Cannet

Cortina d'Ampezzo / 27, Via Cesare Battisti

Viterbo / 6a, Via La Nova – Vitorchiano

Köln <sup>NEW</sup> / Design Post – Deutz-Mülheimer-Str. 22a / Opening January 2021

# Collections and technical information

— 2021

it / Come leggere le informazioni tecniche  
Per ogni collezione sono indicati i materiali e/o i colori in cui è disponibile  
e gli eventuali tessuti di completamento. Per ogni elemento sono riportate  
caratteristiche, dimensioni, peso.

en / How to read the technical information  
For each collection, the materials and/or colours available and any complementary  
fabrics are indicated. For each element features, size and weight are listed.

fr / Comment lire les informations techniques  
Pour chaque collection, les matériaux et/ou les coloris disponibles ainsi que  
les tissus complémentaires éventuels sont indiqués. Pour chaque élément sont  
indiqués: les caractéristiques, les dimensions, le poids.

de / Wie man die technischen Informationen liest  
Für jede Kollektion werden die Materialien und/oder die Farben angegeben,  
in denen die eventuellen Gewebe erhältlich sind. Für jedes Element werden  
Abmessungen, Gewicht, Charakteristika angegeben.

## Legenda Legend / Légende / Legende

 **x**  
peso in kg  
weight in kg  
poids en kg  
Gewicht in kg

 **☐**  
dotato di foro per ombrellone  
equipped with a hole for umbrella  
muni d'un trou pour parasol  
mit Öffnung für Sonnenschirm

 **☐**  
modulare  
modular  
modulaire  
modular

 **☐**  
posizione regolabile  
adjustable position  
position réglable  
verstellbare Position

 **x**  
posti tavolo  
number of seats  
places à table  
Tischplätze

 **☐**  
impermeabile  
waterproof  
imperméable  
undurchlässig

 **☐**  
impilabile  
stackable  
empilable  
stapelbar

 **☐**  
imbottito impermeabile  
water resistant padding  
bourrage imperméable  
Wasserfeste Polsterung

 **☐**  
da assemblare  
to be assembled  
à monter  
zu montieren

 **☐**  
resistente ai raggi uv  
uv resistant  
résistant aux rayons uv  
UV-Strahlen-fest

 **☐**  
pieghevole  
foldable  
pliant  
zusammenklappbar

 **☐**  
dotato di ruote  
with wheels  
avec roulettes  
mit Rädern

 **☐**  
tavolo estensibile  
extendable table  
table avec rallonge  
ausziehbarer Tisch



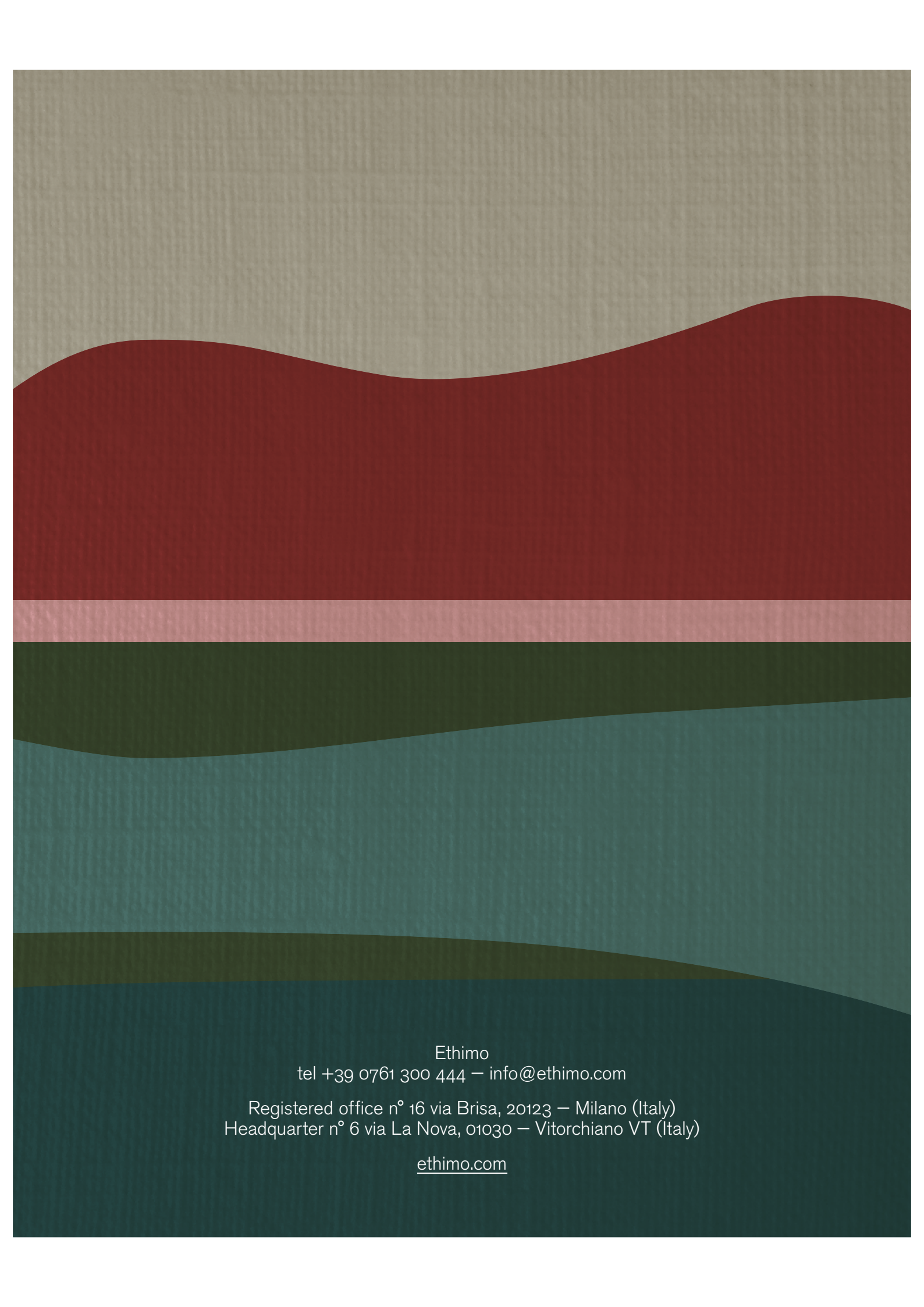

Ethimo

tel +39 0761 300 444 – [info@ethimo.com](mailto:info@ethimo.com)

Registered office n° 16 via Brisa, 20123 – Milano (Italy)  
Headquarter n° 6 via La Nova, 01030 – Vitorchiano VT (Italy)

[ethimo.com](http://ethimo.com)