



2022 CONTRACT



2022 CONTRACT

# L'AZIENDA OUR COMPANY

Quella di EMU è una storia che continua da oltre 70 anni, il racconto di un'azienda Made in Italy universalmente riconosciuta per qualità e design. Oggi come in passato, EMU si distingue per il know-how nella lavorazione e nella protezione del metallo, per la passione e l'entusiasmo delle persone, patrimonio inestimabile dell'azienda. Il sapiente connubio tra innovazione tecnologica, saper fare artigiano e la stretta collaborazione con designer di fama mondiale, rende i prodotti EMU delle soluzioni d'arredo perfette per ogni stile e ambiente.

EMU's story goes back over 70 years and is the tale of a company, one of the Made in Italy leader, that is globally recognised for its quality and design. In EMU, we continue today, as in the past, to stand out for our know-how in processing and protecting metal, for the passion and enthusiasm of our people and for our priceless company heritage. EMU products, the perfect furnishing solution for every style and ambience, are the result of our skillful blend of technological innovation, craftsmen's expertise and close collaboration with world famous designers.



## EMU NEL CONTRACT EMU IN THE CONTRACT SECTOR

Le caratteristiche degli arredi rendono EMU il partner ideale per tutti gli utilizzi contract. Durevolezza, affidabilità, design sono il valore aggiunto di EMU, brand riconosciuto in tutto il mondo come sinonimo di garanzia. Ogni arredo è progettato per resistere alla particolare usura nell'utilizzo contract e alle più avverse condizioni atmosferiche. Tutti i prodotti sono sottoposti ad un rigoroso processo per la protezione e finitura dei metalli che garantisce la longevità all'esterno. La praticità, l'impilabilità, l'utilizzo di tessuti ignifughi, la trasversalità nonché l'estrema funzionalità, semplificano l'impiego dei prodotti EMU, rispondendo perfettamente alle esigenze del settore Hospitality. Grazie a queste sue caratteristiche l'azienda è presente oggi nel mercato internazionale con una rete distributiva che copre oltre 85 Paesi.

Our furnishings' features make EMU the ideal partner for all contract use. A combination of durability, reliability and design brings added value to EMU, so our brand warranty is recognized worldwide. Each piece of furniture is designed to withstand high contractual usage in extreme weather conditions. All our products are subjected to a rigorous process of protection and finishing of metals to ensure a long service life outdoors. Practical and stackable with fire-retardant fabrics, wide appeal and outstanding performance contribute to making EMU products user-friendly and perfect for the requirements of the hotel industry. Thanks to these features, our company now has a strong presence on the international market and has a distribution network covering more than 85 countries.



# EMU E L'AMBIENTE EMU AND THE ENVIRONMENT

L'attenzione che EMU pone verso l'ambiente copre l'intero ciclo di vita del prodotto, dall'impiego di materiali riciclabili al 100%, come l'acciaio e l'alluminio, al riciclo ed alla minimizzazione degli scarti. Le collezioni contenenti il legno sono realizzate in teak FSC® 100%, ovvero proveniente da foreste gestite in maniera responsabile secondo rigorosi standard ambientali, sociali ed economici. L'azienda è anche impegnata nella riduzione costante dell'utilizzo della plastica negli imballi, composti da cartone riciclabile e dalle dimensioni sempre più contenute. La compatibilità ambientale di tutta la gamma EMU è garantita da processi eseguiti all'interno dei propri stabilimenti ed è, inoltre, in sviluppo un impianto fotovoltaico da 1 megawatt entro il 2023, con lo scopo di alimentare l'azienda con energia Green. EMU, 70 anni di evoluzione, mantiene fermi l'entusiasmo per l'innovazione e il rispetto per l'ecosistema. La lunga vita utile del prodotto riduce in maniera significativa l'inquinamento e l'impatto ambientale. EMU realizza prodotti che durano una vita.

EMU focuses on the entire product life cycle within the environment, ranging from its use of 100% recyclable and non-combustible materials, such as steel and aluminium, to recycling and minimising waste. Our collections containing wood are manufactured using 100% FSC® teak from responsibly managed forests in compliance with strict environmental, social and economic standards. Our company is also committed to constantly reducing its use of plastics by using smaller, recyclable cardboard packaging. EMU guarantees the environmental compatibility of its entire product range with processes all carried out in its own plants. At EMU, we are currently developing a 1 megawatt photovoltaic plant for 2023 to supply the company with Green energy. EMU's enthusiasm for innovation and respect for the ecosystem continue after 70 years of evolution. A long product lifespan significantly reduces pollution and environmental impact. EMU creates products that last a lifetime.

## ITALIAN KNOW HOW: UNA GARANZIA DI QUALITÀ ITALIAN KNOW-HOW: GUARANTEED QUALITY

Profondamente legata alla filosofia produttiva 100% Made in Italy e coerente con la cultura del proprio territorio, EMU realizza e controlla tutte le fasi di produzione nel suo stabilimento di Marsciano, nel cuore dell'Umbria. Questo scrupoloso controllo, dai test durante le fasi di progettazione e lavorazione, ai processi di cataforesi e verniciatura fino alla validazione del prodotto finito, assicura prodotti con un lungo ciclo di vita ed una massima resistenza all'utilizzo e agli agenti atmosferici. Infine, tecnici e designer possono trovare, all'interno del Design & Simulation Centre, il luogo ideale per dare impulso alle attività di ricerca e sviluppo. Una cultura che EMU promuove aderendo a progetti universitari ed ospitando frequentemente studenti nel suo reparto di Ricerca & Sviluppo.

EMU realizes and controls all the production phases in its factory in Marsciano, in the heart of Umbria. That's because EMU is deeply bounded to the 100% Made in Italy production philosophy and it is consistent with the culture of its territory. This scrupulous control, starting from the tests during the design and processing phases continuing with the cathaphoresis and painting processes up to the validation of the finished product, ensures longlasting and weather resistant products. Finally, the Design & Simulation Centre is the ideal place where engineers and designers can boost research and development. This is a culture that EMU promotes by joining university projects hosting students, offering them a professional experience in its Research & Development department.



# INDICE COLLEZIONI COLLECTIONS INDEX

## SEDUTE SEATINGS

|    |             |     |           |
|----|-------------|-----|-----------|
| 14 | AERO        | 72  | MOM       |
| 18 | ALA         | 74  | NEF       |
| 20 | APERO       | 76  | PIGALLE   |
| 22 | ARC EN CIEL | 78  | RE-TROUVÉ |
| 24 | ATHENA      | 80  | RIO R50   |
| 28 | BREEZE      | 84  | RIVIERA   |
| 30 | BRIDGE      | 88  | RONDA     |
| 32 | CAPRERA     | 90  | RONDA X   |
| 34 | CAROUSEL    | 92  | ROUND     |
| 44 | CIAK        | 96  | SEGNO     |
| 46 | COMO        | 100 | SHINE     |
| 52 | DARWIN      | 108 | SNOOZE    |
| 56 | GRACE       | 110 | SOLE      |
| 58 | HEAVEN      | 112 | STAR      |
| 62 | HOLLY       | 120 | TERRAMARE |
| 64 | LYZE        | 122 | THOR      |
| 68 | MIA         | 124 | URBAN     |
| 70 | MIKY        | 126 | YARD      |

## TAVOLI A 4 GAMBE 4-LEGGED TABLES

|     |             |     |              |
|-----|-------------|-----|--------------|
| 134 | ARC EN CIEL | 146 | STAR         |
| 136 | CAMBI       | 148 | TABLE SYSTEM |
| 140 | NOVA        | 154 | URBAN        |
| 144 | PIGALLE     | 156 | YARD         |

## TAVOLI A PALO CENTRALE CENTRAL POLE TABLES

|     |           |     |              |
|-----|-----------|-----|--------------|
| 162 | COMO      | 180 | ROUND        |
| 164 | DARWIN    | 184 | SHINE        |
| 168 | GRACE     | 186 | TABLE SYSTEM |
| 170 | HEAVEN    | 200 | TERRAMARE    |
| 172 | HPL TOPS  | 202 | THOR         |
| 178 | RE-TROUVÉ |     |              |

## POLTRONE E DIVANI ARMCHAIRS AND SOFAS

|     |           |
|-----|-----------|
| 208 | CANNOLÈ   |
| 214 | CROSS     |
| 218 | DOCK      |
| 222 | IVY       |
| 224 | TAMI      |
| 232 | TERRAMARE |

## TAVOLI BASSI COFFEE TABLES

|     |          |     |           |
|-----|----------|-----|-----------|
| 242 | ATHENA   | 254 | IVY       |
| 244 | CANNOLÈ  | 256 | RIO R50   |
| 246 | CAROUSEL | 258 | ROUND     |
| 248 | COMO     | 260 | SHINE     |
| 248 | CROSS    | 260 | TAMI      |
| 250 | DARWIN   | 262 | TERRAMARE |
| 252 | HEAVEN   | 264 | YARD      |
| 254 | HOLLY    |     |           |

## LETTINI E SDRAIO SUNBEDS AND DECK CHAIRS

|     |        |     |           |
|-----|--------|-----|-----------|
| 270 | BAHAMA | 282 | TERRAMARE |
| 272 | HOLLY  | 284 | TIKI      |
| 274 | ROUND  | 286 | VETTA     |
| 276 | SHINE  | 288 | YARD      |
| 278 | SNOOZE |     |           |

## OMBRELLONI SUNSHADES

|     |           |
|-----|-----------|
| 292 | SHADE     |
| 296 | SHADE PRO |

## COMPLEMENTI COMPLEMENTS

|     |            |
|-----|------------|
| 302 | CONE       |
| 306 | FIGUS      |
| 310 | HEAVEN     |
| 312 | LUCIOLE    |
| 314 | PATCHWALL  |
| 318 | RE-TROUVÉ  |
| 320 | RED CARPET |

## CUSCINI CUSHIONS

|     |                     |
|-----|---------------------|
| 324 | DECORATIVE CUSHIONS |
| 326 | EMU CUSHIONS        |
| 327 | MAGNETIC CUSHIONS   |
| 328 | UNIVERSAL CUSHIONS  |



# TIPOLOGIE E MATERIALI

## CATEGORIES AND MATERIALS

|           | Sedia—Chair | Poltroncina—Armchair | Sgabello—Barstool | Tavolo alto—Counter table | Tavolo—Table | Tavolo basso—Coffee table | Panchina—Bench | Poltrona—Lounge chair | Poltrona dondolo—Rocking lounge chair | Pouf / Poggiapiedi—Pouf / Footrest | Divano—Sofa | Divano modulare—Modular sofa | Letino—Sunbed | Sdraio—Deck chair | Ombrellone—Shade | Lampada—Lamp | Complementi—Complements | Acciaio—Steel | Alluminio—Aluminium | Legno—Wood |
|-----------|-------------|----------------------|-------------------|---------------------------|--------------|---------------------------|----------------|-----------------------|---------------------------------------|------------------------------------|-------------|------------------------------|---------------|-------------------|------------------|--------------|-------------------------|---------------|---------------------|------------|
| AERO      | ●           | ●                    | ●                 | ●                         | ●            | ●                         | ●              | ●                     | ●                                     | ●                                  | ●           | ●                            | ●             | ●                 | ●                | ●            | ●                       | ●             | ●                   | ●          |
| ALA       | ●           | ●                    | ●                 | ●                         | ●            | ●                         | ●              | ●                     | ●                                     | ●                                  | ●           | ●                            | ●             | ●                 | ●                | ●            | ●                       | ●             | ●                   | ●          |
| APERO     | ●           | ●                    | ●                 | ●                         | ●            | ●                         | ●              | ●                     | ●                                     | ●                                  | ●           | ●                            | ●             | ●                 | ●                | ●            | ●                       | ●             | ●                   | ●          |
| ARCENCIEL | ●           | ●                    | ●                 | ●                         | ●            | ●                         | ●              | ●                     | ●                                     | ●                                  | ●           | ●                            | ●             | ●                 | ●                | ●            | ●                       | ●             | ●                   | ●          |
| ATHENA    | ●           | ●                    | ●                 | ●                         | ●            | ●                         | ●              | ●                     | ●                                     | ●                                  | ●           | ●                            | ●             | ●                 | ●                | ●            | ●                       | ●             | ●                   | ●          |
| BAHAMA    | ●           | ●                    | ●                 | ●                         | ●            | ●                         | ●              | ●                     | ●                                     | ●                                  | ●           | ●                            | ●             | ●                 | ●                | ●            | ●                       | ●             | ●                   | ●          |
| BREEZE    | ●           | ●                    | ●                 | ●                         | ●            | ●                         | ●              | ●                     | ●                                     | ●                                  | ●           | ●                            | ●             | ●                 | ●                | ●            | ●                       | ●             | ●                   | ●          |
| BRIDGE    | ●           | ●                    | ●                 | ●                         | ●            | ●                         | ●              | ●                     | ●                                     | ●                                  | ●           | ●                            | ●             | ●                 | ●                | ●            | ●                       | ●             | ●                   | ●          |
| CAMBI     | ●           | ●                    | ●                 | ●                         | ●            | ●                         | ●              | ●                     | ●                                     | ●                                  | ●           | ●                            | ●             | ●                 | ●                | ●            | ●                       | ●             | ●                   | ●          |
| CANNOLE   | ●           | ●                    | ●                 | ●                         | ●            | ●                         | ●              | ●                     | ●                                     | ●                                  | ●           | ●                            | ●             | ●                 | ●                | ●            | ●                       | ●             | ●                   | ●          |
| CAPRERA   | ●           | ●                    | ●                 | ●                         | ●            | ●                         | ●              | ●                     | ●                                     | ●                                  | ●           | ●                            | ●             | ●                 | ●                | ●            | ●                       | ●             | ●                   | ●          |
| CAROUSEL  | ●           | ●                    | ●                 | ●                         | ●            | ●                         | ●              | ●                     | ●                                     | ●                                  | ●           | ●                            | ●             | ●                 | ●                | ●            | ●                       | ●             | ●                   | ●          |
| CIAK      | ●           | ●                    | ●                 | ●                         | ●            | ●                         | ●              | ●                     | ●                                     | ●                                  | ●           | ●                            | ●             | ●                 | ●                | ●            | ●                       | ●             | ●                   | ●          |
| COMO      | ●           | ●                    | ●                 | ●                         | ●            | ●                         | ●              | ●                     | ●                                     | ●                                  | ●           | ●                            | ●             | ●                 | ●                | ●            | ●                       | ●             | ●                   | ●          |
| CONE      | ●           | ●                    | ●                 | ●                         | ●            | ●                         | ●              | ●                     | ●                                     | ●                                  | ●           | ●                            | ●             | ●                 | ●                | ●            | ●                       | ●             | ●                   | ●          |
| CROSS     | ●           | ●                    | ●                 | ●                         | ●            | ●                         | ●              | ●                     | ●                                     | ●                                  | ●           | ●                            | ●             | ●                 | ●                | ●            | ●                       | ●             | ●                   | ●          |
| DARWIN    | ●           | ●                    | ●                 | ●                         | ●            | ●                         | ●              | ●                     | ●                                     | ●                                  | ●           | ●                            | ●             | ●                 | ●                | ●            | ●                       | ●             | ●                   | ●          |
| DOCK      | ●           | ●                    | ●                 | ●                         | ●            | ●                         | ●              | ●                     | ●                                     | ●                                  | ●           | ●                            | ●             | ●                 | ●                | ●            | ●                       | ●             | ●                   | ●          |
| FICUS     | ●           | ●                    | ●                 | ●                         | ●            | ●                         | ●              | ●                     | ●                                     | ●                                  | ●           | ●                            | ●             | ●                 | ●                | ●            | ●                       | ●             | ●                   | ●          |
| GRACE     | ●           | ●                    | ●                 | ●                         | ●            | ●                         | ●              | ●                     | ●                                     | ●                                  | ●           | ●                            | ●             | ●                 | ●                | ●            | ●                       | ●             | ●                   | ●          |
| HEAVEN    | ●           | ●                    | ●                 | ●                         | ●            | ●                         | ●              | ●                     | ●                                     | ●                                  | ●           | ●                            | ●             | ●                 | ●                | ●            | ●                       | ●             | ●                   | ●          |
| HOLLY     | ●           | ●                    | ●                 | ●                         | ●            | ●                         | ●              | ●                     | ●                                     | ●                                  | ●           | ●                            | ●             | ●                 | ●                | ●            | ●                       | ●             | ●                   | ●          |
| HPL TOPS  | ●           | ●                    | ●                 | ●                         | ●            | ●                         | ●              | ●                     | ●                                     | ●                                  | ●           | ●                            | ●             | ●                 | ●                | ●            | ●                       | ●             | ●                   | ●          |
| IVY       | ●           | ●                    | ●                 | ●                         | ●            | ●                         | ●              | ●                     | ●                                     | ●                                  | ●           | ●                            | ●             | ●                 | ●                | ●            | ●                       | ●             | ●                   | ●          |
| LUCIOLE   | ●           | ●                    | ●                 | ●                         | ●            | ●                         | ●              | ●                     | ●                                     | ●                                  | ●           | ●                            | ●             | ●                 | ●                | ●            | ●                       | ●             | ●                   | ●          |
| LYZE      | ●           | ●                    | ●                 | ●                         | ●            | ●                         | ●              | ●                     | ●                                     | ●                                  | ●           | ●                            | ●             | ●                 | ●                | ●            | ●                       | ●             | ●                   | ●          |
| MIA       | ●           | ●                    | ●                 | ●                         | ●            | ●                         | ●              | ●                     | ●                                     | ●                                  | ●           | ●                            | ●             | ●                 | ●                | ●            | ●                       | ●             | ●                   | ●          |
| MIKY      | ●           | ●                    | ●                 | ●                         | ●            | ●                         | ●              | ●                     | ●                                     | ●                                  | ●           | ●                            | ●             | ●                 | ●                | ●            | ●                       | ●             | ●                   | ●          |

|              | Sedia—Chair | Poltroncina—Armchair | Sgabello—Barstool | Tavolo alto—Counter table | Tavolo—Table | Tavolo basso—Coffee table | Panchina—Bench | Poltrona—Lounge chair | Poltrona dondolo—Rocking lounge chair | Pouf / Poggiapiedi—Pouf / Footrest | Divano—Sofa | Divano modulare—Modular sofa | Letino—Sunbed | Sdraio—Deck chair | Ombrellone—Shade | Lampada—Lamp | Complementi—Complements | Acciaio—Steel | Alluminio—Aluminium | Legno—Wood |
|--------------|-------------|----------------------|-------------------|---------------------------|--------------|---------------------------|----------------|-----------------------|---------------------------------------|------------------------------------|-------------|------------------------------|---------------|-------------------|------------------|--------------|-------------------------|---------------|---------------------|------------|
| MOM          | ●           | ●                    | ●                 | ●                         | ●            | ●                         | ●              | ●                     | ●                                     | ●                                  | ●           | ●                            | ●             | ●                 | ●                | ●            | ●                       | ●             | ●                   | ●          |
| NEF          | ●           | ●                    | ●                 | ●                         | ●            | ●                         | ●              | ●                     | ●                                     | ●                                  | ●           | ●                            | ●             | ●                 | ●                | ●            | ●                       | ●             | ●                   | ●          |
| NOVA         | ●           | ●                    | ●                 | ●                         | ●            | ●                         | ●              | ●                     | ●                                     | ●                                  | ●           | ●                            | ●             | ●                 | ●                | ●            | ●                       | ●             | ●                   | ●          |
| PATCHWALL    | ●           | ●                    | ●                 | ●                         | ●            | ●                         | ●              | ●                     | ●                                     | ●                                  | ●           | ●                            | ●             | ●                 | ●                | ●            | ●                       | ●             | ●                   | ●          |
| PIGALLE      | ●           | ●                    | ●                 | ●                         | ●            | ●                         | ●              | ●                     | ●                                     | ●                                  | ●           | ●                            | ●             | ●                 | ●                | ●            | ●                       | ●             | ●                   | ●          |
| RE-TROUVÉ    | ●           | ●                    | ●                 | ●                         | ●            | ●                         | ●              | ●                     | ●                                     | ●                                  | ●           | ●                            | ●             | ●                 | ●                | ●            | ●                       | ●             | ●                   | ●          |
| REDCARPET    | ●           | ●                    | ●                 | ●                         | ●            | ●                         | ●              | ●                     | ●                                     | ●                                  | ●           | ●                            | ●             | ●                 | ●                | ●            | ●                       | ●             | ●                   | ●          |
| RIO R50      | ●           | ●                    | ●                 | ●                         | ●            | ●                         | ●              | ●                     | ●                                     | ●                                  | ●           | ●                            | ●             | ●                 | ●                | ●            | ●                       | ●             | ●                   | ●          |
| RIVIERA      | ●           | ●                    | ●                 | ●                         | ●            | ●                         | ●              | ●                     | ●                                     | ●                                  | ●           | ●                            | ●             | ●                 | ●                | ●            | ●                       | ●             | ●                   | ●          |
| RONDA        | ●           | ●                    | ●                 | ●                         | ●            | ●                         | ●              | ●                     | ●                                     | ●                                  | ●           | ●                            | ●             | ●                 | ●                | ●            | ●                       | ●             | ●                   | ●          |
| RONDAX       | ●           | ●                    | ●                 | ●                         | ●            | ●                         | ●              | ●                     | ●                                     | ●                                  | ●           | ●                            | ●             | ●                 | ●                | ●            | ●                       | ●             | ●                   | ●          |
| ROUND        | ●           | ●                    | ●                 | ●                         | ●            | ●                         | ●              | ●                     | ●                                     | ●                                  | ●           | ●                            | ●             | ●                 | ●                | ●            | ●                       | ●             | ●                   | ●          |
| SEGNO        | ●           | ●                    | ●                 | ●                         | ●            | ●                         | ●              | ●                     | ●                                     | ●                                  | ●           | ●                            | ●             | ●                 | ●                | ●            | ●                       | ●             | ●                   | ●          |
| SHADE        | ●           | ●                    | ●                 | ●                         | ●            | ●                         | ●              | ●                     | ●                                     | ●                                  | ●           | ●                            | ●             | ●                 | ●                | ●            | ●                       | ●             | ●                   | ●          |
| SHADE PRO    | ●           | ●                    | ●                 | ●                         | ●            | ●                         | ●              | ●                     | ●                                     | ●                                  | ●           | ●                            | ●             | ●                 | ●                | ●            | ●                       | ●             | ●                   | ●          |
| SHINE        | ●           | ●                    | ●                 | ●                         | ●            | ●                         | ●              | ●                     | ●                                     | ●                                  | ●           | ●                            | ●             | ●                 | ●                | ●            | ●                       | ●             | ●                   | ●          |
| SNOOZE       | ●           | ●                    | ●                 | ●                         | ●            | ●                         | ●              | ●                     | ●                                     | ●                                  | ●           | ●                            | ●             | ●                 | ●                | ●            | ●                       | ●             | ●                   | ●          |
| SOLE         | ●           | ●                    | ●                 | ●                         | ●            | ●                         | ●              | ●                     | ●                                     | ●                                  | ●           | ●                            | ●             | ●                 | ●                | ●            | ●                       | ●             | ●                   | ●          |
| STAR         | ●           | ●                    | ●                 | ●                         | ●            | ●                         | ●              | ●                     | ●                                     | ●                                  | ●           | ●                            | ●             | ●                 | ●                | ●            | ●                       | ●             | ●                   | ●          |
| STAR         | ●           | ●                    | ●                 | ●                         | ●            | ●                         | ●              | ●                     | ●                                     | ●                                  | ●           | ●                            | ●             | ●                 | ●                | ●            | ●                       | ●             | ●                   | ●          |
| TABLE SYSTEM | ●           | ●                    | ●                 | ●                         | ●            | ●                         | ●              | ●                     | ●                                     | ●                                  | ●           | ●                            | ●             | ●                 | ●                | ●            | ●                       | ●             | ●                   | ●          |
| TAMI         | ●           | ●                    | ●                 | ●                         | ●            | ●                         | ●              | ●                     | ●                                     | ●                                  | ●           | ●                            | ●             | ●                 | ●                | ●            | ●                       | ●             | ●                   | ●          |
| TERRAMARE    | ●           | ●                    | ●                 | ●                         | ●            | ●                         | ●              | ●                     | ●                                     | ●                                  | ●           | ●                            | ●             | ●                 | ●                | ●            | ●                       | ●             | ●                   | ●          |
| THOR         | ●           | ●                    | ●                 | ●                         | ●            | ●                         | ●              | ●                     | ●                                     | ●                                  | ●           | ●                            | ●             | ●                 | ●                | ●            | ●                       | ●             | ●                   | ●          |
| TIKI         | ●           | ●                    | ●                 | ●                         | ●            | ●                         | ●              | ●                     | ●                                     | ●                                  | ●           | ●                            | ●             | ●                 | ●                | ●            | ●                       | ●             | ●                   | ●          |
| URBAN        | ●           | ●                    | ●                 | ●                         | ●            | ●                         | ●              | ●                     | ●                                     | ●                                  | ●           | ●                            | ●             | ●                 | ●                | ●            | ●                       | ●             | ●                   | ●          |
| VETTA        | ●           | ●                    | ●                 | ●                         | ●            | ●                         | ●              | ●                     | ●                                     | ●                                  | ●           | ●                            | ●             | ●                 | ●                | ●            | ●                       | ●             | ●                   | ●          |
| YARD         | ●           | ●                    | ●                 | ●                         | ●            | ●                         | ●              | ●                     | ●                                     | ●                                  | ●           | ●                            | ●             | ●                 | ●                | ●            | ●                       | ●             | ●                   | ●          |

# LEGENDA DEI SIMBOLI SYMBOLS LEGEND



## CATEGORIE—CATEGORIES

| Icona | Descrizione                                   | Icona | Descrizione                              | Icona | Descrizione                |
|-------|---|-------|--|-------|----------------------------|
|       | Sedute—Seatings                               |       | Poltrone e Divani<br>Armchairs and Sofas |       | Ombrelloni—Umbrellas       |
|       | Tavoli a 4 gambe<br>4-legged tables           |       | Tavoli bassi<br>Coffee Tables            |       | Complementi<br>Complements |
|       | Tavoli a palo centrale<br>Central pole tables |       | Lettoni e Sdraio<br>Sunbeds and Deck     |       |                            |

## MATERIALI—MATERIALS

| Icona | Descrizione         | Note  |
|-------|---------------------|---|
|       | Acciaio—Steel       | ● Lega di ferro e carbonio con percentuale di carbonio inferiore al 2% trattata per resistere agli agenti atmosferici con l'esclusivo processo anticorrosione EMU-Coat.<br>Iron and carbon alloy, with carbon content below 2%, treated to withstand the elements with the unique EMU.  |
|       | Alluminio—Aluminium | ● Leghe di alluminio, particolarmente idonee per la lavorazione a freddo e per la pressofusione, trattate opportunamente per resistere agli agenti atmosferici e verniciate a polvere.<br>Aluminium alloys, particularly suitable for cold-working and for die-casting, appropriately treated to withstand the elements and powder coated.  |
|       | Legno—Wood          | ● Materiale naturale derivato da specie vegetali. Il bambù è un materiale derivato dalla pianta di bambù. Il teak è un legno duro ad alto contenuto di olio adatto all'uso esterno senza necessità di trattamento di verniciatura. Il teak utilizzato per i prodotti EMU è certificato FSC®.<br>Natural material obtained from plant species. Bamboo is a material obtained from the bamboo plant. Teak is a hard wood with a high oil content suitable for outdoor use, without the need for painting. The teak used for EMU products is FSC® certified. |

## INFORMAZIONI—INFORMATIONS

| Icona | Descrizione                                       | Note   |
|-------|---|--|
|       | Resistenza al fuoco<br>Flame retardant            | Indica una capacità di resistenza contro fonti di calore o fuoco e non contribuisce a potenziare l'incendio.<br>Indicates a capacity of resistance against heat or fire sources and does not contribute to enhancing the fire.   |
|       | Riciclabilità—Recyclability                       | Indica che il materiale è recuperabile e riutilizzabile per la produzione di un nuovo prodotto. Schede riciclabilità disponibili all'interno della sezione "Prodotti" del sito <a href="http://www.emu.it">www.emu.it</a> .<br>Indicates that the material is recoverable and reusable for the production of a new product. Recycling data sheets available on "Products" area of <a href="http://www.emu.it">www.emu.it</a> . |
|       | Configurabile sul sito<br>Configurable on website | Indica che il prodotto può essere personalizzato e visualizzato sul sito con le diverse combinazioni di colori e tessuti.<br>Indicates that the product can be customized and displayed on the website with the different combinations of colors and fabrics.  |

## INFORMAZIONI TECNICHE—TECHNICAL INFORMATION

| Icona | Descrizione   | Note   |
|-------|---|--|
|       | Trattamento   | La lettera C accanto all'icona indica che l'acciaio ha ricevuto un trattamento superficiale protettivo di cataforesi.<br>La lettera Z accanto all'icona indica che l'acciaio ha ricevuto un trattamento superficiale protettivo di zincatura.<br>The letter C next to the icon indicates that the steel has received a protective cathoresis surface treatment.<br>The letter Z next to the icon indicates that the steel has received a protective galvanizing surface treatment. |
|       | Carico statico (in Kg)<br>Static load (in Kg)           | Per le sedute si riferisce al carico statico esercitato sulla singola seduta, per i tavoli alla forza esercitata in punti prestabiliti del piano. È previsto dai test comunitari inerenti ai requisiti meccanici dei prodotti.<br>For seatings this refers to the static load applied to the single seat, and for tables to the force applied to pre-established points of the table-top.  |
|       | Resistente all'esterno<br>Resistant to outdoor exposure |  |
|       | Cuscino seduta+schienale<br>Seat+back cushion           | Indica che al prodotto può essere abbinato il cuscino seduta + schienale.<br>Indicates that a seat-back cushion can be combined with the product.  |
|       | Cuscino seduta<br>Seat cushion                          | Indica che al prodotto può essere abbinato il cuscino seduta.<br>Indicates that a seat cushion can be combined with the product.   |
|       | Cuscino schienale<br>Back cushion                       | Indica che al prodotto può essere abbinato il cuscino schienale.<br>Indicates that a back cushion can be combined with the product.  |
|       | Piano in cristallo<br>Glass top                         | Indica che al prodotto può essere abbinato il piano in cristallo.<br>Indicates that a glass top can be combined with the product.  |
|       | Impilabile<br>Stackable                                 | Il numero accanto all'icona indica il numero massimo di sedie impilabili.<br>The number at the top gives the maximum number of products that can be stacked.   |
|       | Pieghevole—Foldable                                     |  |
|       | Reclinabile—Reclining                                   |  |
|       | Allungabile—Extensible                                  |  |
|       | Abbattibile—Collapsible                                 |  |
|       | Cover   | Indica che al prodotto può essere abbinato il telo di protezione.<br>Indicates that a matching protective cover can be combined with the product.  |
|       | Codice IP—IP code                                       | Il codice IP (International Protection) indica il grado di protezione degli involucri dei dispositivi elettrici ed elettronici contro la penetrazione di agenti esterni di natura solida o liquida.<br>The International Protection code (IP) indicates the degree of protection of electrical and electronic device casings against penetration of solid or liquid external agents.   |
|       | Protezione raggi UV<br>UV ray protection                | Il numero accanto all'icona indica il valore di protezione del prodotto ai raggi ultravioletti secondo la classificazione UPF.<br>The number on the right indicates the UV rays protection of the product in the UPF range.  |
|       | FSC®  | Indica prodotti contenenti materiali certificati FSC®, ovvero provenienti da foreste gestite in maniera responsabile secondo rigorosi standard ambientali, sociali ed economici.<br>Indicates products containing FSC® certified materials which come from responsibly managed forests, according to rigorous environmental, social and economic standards.  |



RE-TROUVÉ—NOVOTEL HEATHROW AIRPORT—UK



AERO—TNT HOOFDDORP—HOLLAND

# EMU NEL MONDO EMU IN THE WORLD



ROUND—KOMBUIS RESTAURANT—SOUTH AFRICA



# SEDUTE SEATINGS

Le sedute EMU sono concepite per migliorare l'esperienza e la fruizione di chi le vive, reinterpretando con carattere gli spazi sia esterni che interni. La loro trasversalità per design, materiale e funzionalità, permette di scegliere tra molteplici soluzioni: sedute impilabili e pieghevoli, con o senza braccioli, con cuscini dedicati e diverse finiture. Le sedie EMU, certificate da enti riconosciuti a livello internazionale, sono una sintesi perfetta tra tecnologia, estetica e comfort, una garanzia di eccezionale prestazione, anche nell'utilizzo prolungato e in condizioni atmosferiche estreme.

EMU chairs are designed to enhance the user experience and reinterpret indoor and outdoor spaces with character. The large appeal of the design, materials and functions enable you to choose among numerous solutions: stackability, folding seats, with or without arms, with tailor-made cushions and various finishes. EMU chairs are certified by internationally recognized authorities and provide the perfect combination of technology, aesthetics and comfort to ensure performance over many years in extreme weather conditions.

## INDEX

LEGENDA—LEGEND  
 ● Acciaio—Steel  
 ● Alluminio—Aluminium  
 ● Legno—Wood

|    |           |    |     |           |    |
|----|-----------|----|-----|-----------|----|
| 14 | AERO      | ●  | 72  | MOM       | ●  |
| 18 | ALA       | ●  | 74  | NEF       | ●  |
| 20 | APER0     | ●  | 76  | PIGALLE   | ●  |
| 22 | ARCENCIEL | ●  | 78  | RE-TROUVÉ | ●  |
| 24 | ATHENA    | ●  | 80  | RIO R50   | ●  |
| 28 | BREEZE    | ●  | 84  | RIVIERA   | ●  |
| 30 | BRIDGE    | ●  | 88  | RONDA     | ●  |
| 32 | CAPRERA   | ●  | 90  | RONDA X   | ●  |
| 34 | CAROUSEL  | ●  | 92  | ROUND     | ●  |
| 44 | CIAK      | ●  | 96  | SEGNO     | ●● |
| 46 | COMO      | ●  | 100 | SHINE     | ●● |
| 52 | DARWIN    | ●  | 108 | SNOOZE    | ●  |
| 56 | GRACE     | ●  | 110 | SOLE      | ●  |
| 58 | HEAVEN    | ●  | 112 | STAR      | ●● |
| 62 | HOLLY     | ●  | 120 | TERRAMARE | ●  |
| 64 | LYZE      | ●● | 122 | THOR      | ●● |
| 68 | MIA       | ●  | 124 | URBAN     | ●  |
| 70 | MIKY      | ●  | 126 | YARD      | ●  |





Scansiona e scopri i progetti.  
Scan and discover the projects.

**023**  
Poltrona  
Lounge chair



I piatti di sedile e schienale sono saldati a TIG alla struttura perimetrale in tondino di acciaio. Tale tecnica permette una maggiore precisione, qualità e resistenza delle saldature. Seat and back profiles are TIG welded on the steel bar perimeter frame. This technique allows a greater precision, quality and resistance of the weldings.

**024**  
Sgabello  
Barstool

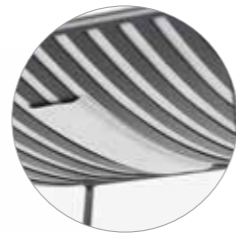

Cuscino sfoderabile in tessuto, con un pratico sistema di fissaggio in velcro. Cover removable cushion in acrylic fabric, with a handy velcro fastening.

## PRODOTTI—PRODUCTS



| Codice/Code<br>Tipologia/Typology | Disegno/Drawing | Info |
|-----------------------------------|-----------------|------|
|-----------------------------------|-----------------|------|

**023**  
Poltrona  
Lounge chair  
W66 - D70 - H64  
Kg 9,4

**024**  
Sgabello  
Barstool  
W43 - D46 - H100  
Kg 6,2

### COLORI STRUTTURA—FRAME COLORS

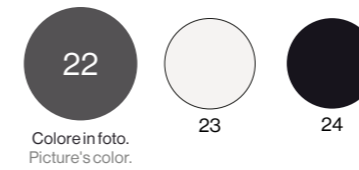

### CUSCINI—CUSHIONS

| Codice/Code<br>Tipologia/Typology   | Colori tessuto<br>Fabric colors                          | Categoria tessuto<br>Fabric category   |
|---|--|--|
| <b>C/023</b><br>Cuscino seduta acrilico<br>Acrylic seat cushion<br>x cod. 023<br>W57 - D52 - H2<br>Kg 0,33                                  | 700/12*<br>700/13<br>700/14                              | Tessuti Basic<br>Basic Fabrics         |
| <b>C/026</b><br>Cuscino seduta acrilico<br>Acrylic seat cushion<br>x cod. 024<br>W35 - D31 - H2<br>Kg 0,16                                  | 700/12*<br>700/13<br>700/14                              | Tessuti Basic<br>Basic Fabrics         |
| <b>C/712</b><br>Cuscino magnetico EMU-TEX rettangolare<br>Rectangular EMU-TEX magnetic cushion<br>x cod. 024<br>W40 - D28 - H1,5<br>Kg 0,18 | 300/10<br>300/11<br>300/12<br>300/13<br>300/14<br>300/15 | Cuscini Magnetici<br>Magnetic Cushions |
| <b>C/713</b><br>Cuscino magnetico EMU-TEX poltrona<br>Lounge chair EMU-TEX magnetic cushion<br>x cod. 023<br>W53 - D44 - H1,5<br>Kg 0,3     | 300/10<br>300/11<br>300/12<br>300/13<br>300/14<br>300/15 | Cuscini Magnetici<br>Magnetic Cushions |

\* Cuscino visibile in foto—Cushion in the picture

# AERO

Design by Paul Newman



Scansiona e scopri i progetti.  
Scan and discover the projects.

027  
Sedia  
Chair



## PRODOTTI—PRODUCTS



| Codice/Code<br>Tipologia/Typology | Disegno/Drawing | Info |
|-----------------------------------|-----------------|------|
|-----------------------------------|-----------------|------|

027

Sedia  
Chair

W49 - D49 - H77  
Kg 6,4

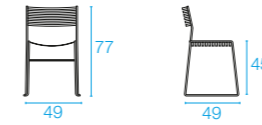

### COLORI STRUTTURA—FRAME COLORS

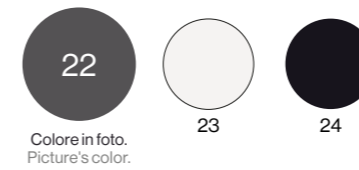

Colore in foto.  
Picture's color.

### CUSCINI—CUSHIONS

| Codice/Code<br>Tipologia/Typology   | Colori tessuto<br>Fabric colors | Categoria tessuto<br>Fabric category |
|---|---------------------------------|--------------------------------------|
| C/027<br>Cuscino seduta acrilico<br>Acrylic seat cushion<br>x cod. 027<br>W42 - D34 - H2<br>Kg 0,16 | 700/12*<br>700/13<br>700/14     | Tessuti Basic<br>Basic Fabrics       |



\* Cuscino visibile in foto—Cushion in the picture

### COMBINAZIONI CONSIGLIATE—SUGGESTED MATCHINGS

16



ROUND  
Cod. 476  
Tavolo rettangolare 2 posti  
2 seats rectangular table  
PAG. 182



NOVA  
Cod. 854  
Tavolo rettangolare 4/6 posti  
4/6 seats rectangular table  
PAG. 140



DARWIN  
Cod. 528  
Tavolo alto abbattibile 2 posti  
2 seats collapsible high table  
PAG. 164

## PLUS

- La piegatura del tondino in acciaio (cataforizzato e verniciato) costituisce la caratteristica forma della gamba a slitta.—The folding of the cataphorised and painted steel bar shapes the characteristic slide leg.
- Cuscini magnetici universali a calamita.—Universal magnetic cushions.

17



Scansiona e scopri i progetti.  
Scan and discover the projects.



150  
Sedia  
Chair



Lamiera zincata a caldo forata ad effetto finto intreccio.  
Hot-dip zinc-plated sheet with simulated woven wire mesh.

151  
Poltroncina  
Armchair



Fissaggio cuscino con laccetti.  
Cushion fastening with laces.

## PRODOTTI—PRODUCTS

| Codice/Code<br>Tipologia/Typology                           | Disegno/Drawing | Info | TEST             |
|---|-----------------|------|------------------|
| 150<br>Sedia<br>Chair<br>W57 - D58 - H86<br>Kg 5,3          |                 |      | EN581-1/ EN581-2 |
| 151<br>Poltroncina<br>Armchair<br>W58 - D58 - H86<br>Kg 6,0 |                 |      | EN581-1/ EN581-2 |

### COLORI STRUTTURA—FRAME COLORS

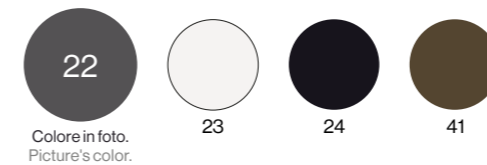

### CUSCINI—CUSHIONS

| Codice/Code<br>Tipologia/Typology  | Colori tessuto<br>Fabric colors | Categoria tessuto<br>Fabric category   |
|--|---------------------------------|--|
| C/152<br>Cuscino seduta acrilico<br>Acrylic seat cushion<br>x cod. 150, 151<br>W40/44 - D36 - H2<br>Kg 0,14                      |                                 | Tessuti Basic<br>Basic Fabrics         |
| C/710<br>Cuscino magnetico EMU-Tex quadrato<br>Square EMU-Tex magnetic cushion<br>x cod. 150, 151<br>W39 - D37 - H1,5<br>Kg 0,23 |                                 | Cuscini Magnetici<br>Magnetic Cushions |

\* Cuscino visibile in foto—Cushion in the picture

### COMBINAZIONI CONSIGLIATE—SUGGESTED MATCHINGS



CAMBI  
Cod. 804  
Tavolo tondo 5 posti  
5 seats round table  
PAG. 138



CAMBI  
Cod. 808  
Tavolo rettangolare 6 posti  
6 seats rectangular table  
PAG. 138



TABLE SYSTEM  
Cod. 1171  
Tavolo bordo squadrato  
5/6 posti  
5/6 seats square border table  
PAG. 198

## PLUS

- Tubo acciaio cataforizzato e verniciato.—Cataphorised and painted steel pipe.
- Saldatura a proiezione della rete alla struttura in tubolare che conferisce un migliore effetto estetico.  
Spot welding of the mesh to the tubular frame which gives a better aesthetic effect.
- Cuscini magnetici universali a calamita.—Universal magnetic cushions.

# APERRO

Design by Martin Drechsel



Scansiona e scopri i progetti.  
Scan and discover the projects.



1300  
Sedia  
Chair



Fissaggio a scomparsa del cuscino tramite laccetti.  
Invisible cushion fastening with hidden laces.

1301  
Poltroncina  
Armchair



Sofisticato e minimale design realizzato con tondini sagomati per garantire comfort ed ergonomia.  
Collection of seats characterized by a sophisticated and essential design made with shaped bars to ensure comfort and ergonomics.

1303  
Sgabello  
Barstool



Saldature a MIG e saldobrasatura nella parte visibile dei tondini.  
MIG welding and braze welding in the visible part of the bars.

## PRODOTTI—PRODUCTS

| Codice/Code<br>Tipologia/Typology | Disegno/Drawing | Info |
|-----------------------------------|-----------------|------|
|-----------------------------------|-----------------|------|

1300

Sedia  
Chair  
W50 - D52 - H78  
Kg 5,4

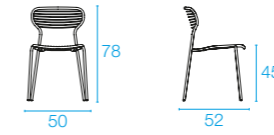

1301

Poltroncina  
Armchair  
W55,5 - D52 - H78  
Kg 5,9



1303

Sgabello  
Barstool  
W53 - D55 - H101  
Kg 7,0

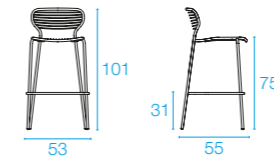

### COLORI STRUTTURA—FRAME COLORS

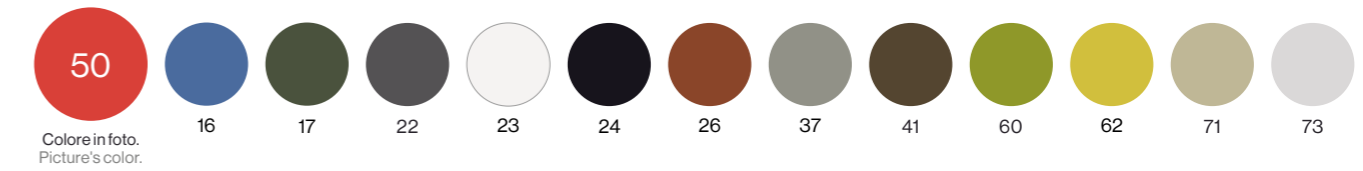

### CUSCINI—CUSHIONS

| Codice/Code<br>Tipologia/Typology  | Colori tessuto<br>Fabric colors | Categoria tessuto<br>Fabric category |
|--|---------------------------------|--------------------------------------|
| C/1300<br>Cuscino seduta<br>Seat cushion<br>x cod. 1300, 1301, 1303<br>W44 - D41 - H2<br>Kg 0,21 | 700/4                           | Tessuti Basic<br>Basic Fabrics       |
|  | 700/10                          |                                      |
|  | 700/12                          |                                      |
|  | 700/13                          |                                      |
|  | 700/14                          | Tessuti Standard<br>Standard Fabrics |
|  | 900/02                          |                                      |
|  | 900/03                          |                                      |
|  | 900/05                          |                                      |
|  | 900/06                          |                                      |
|  | 900/07                          |                                      |
|  | 900/08                          |                                      |
|  | 900/09*                         |                                      |
|  | 900/71                          |                                      |
|  | 900/75                          |                                      |
| 900/77   |                                 |                                      |

\* Cuscino visibile in foto—Cushion in the picture

### COMBINAZIONI CONSIGLIATE—SUGGESTED MATCHINGS

20



DARWIN  
Cod. 525  
Tavolo abbattibile 2 posti  
2 seats collapsible table  
PAG. 164



NOVA  
Cod. 854  
Tavolo rettangolare 4/6 posti  
4/6 seats rectangular table  
PAG. 140



NOVA  
Cod. 890  
Tavolo alto quadrato 2 posti  
2 seats counter square table  
PAG. 142

21

# ARC EN CIEL

Design by EMU



Scansiona e scopri i progetti.  
Scan and discover the projects.

314  
Sedia Pieghevole  
Folding chair

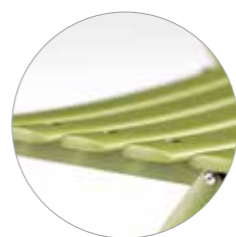

Stecche in lamiera di acciaio zincata a caldo e imbutita. Le stecche sono sagomate per aumentare il comfort alla seduta.  
Deep-drawn slats in hot-dip zincated steel sheet. The slats are shaped to increase comfort to the seat.



Pieghevole, di dimensioni compatte, consente un facile rimessaggio serale e/o invernale in utilizzo contract.  
Foldable and compact, it allows easy storage in the evening and/or winter when used in contract environments.

## ALTRI PRODOTTI IN COLLEZIONE—OTHER COLLECTION'S PRODUCTS



ARC EN CIEL  
Cod. 334  
Tavolo pieghevole 2 posti  
2 seats folding table  
PAG. 134



ARC EN CIEL  
Cod. 331  
Tavolo pieghevole 4 posti  
4 seats folding table  
PAG. 134



ARC EN CIEL  
Cod. 346  
Tavolo pieghevole 2/4 posti  
2/4 seats folding table  
PAG. 134

## PRODOTTI—PRODUCTS



| Codice/Code<br>Tipologia/Typology | Disegno/Drawing | Info |
|-----------------------------------|-----------------|------|
|-----------------------------------|-----------------|------|

314  
Sedia pieghevole  
Folding chair  
W42,5 - D43 - H81  
Kg 4,8

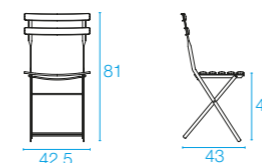

### COLORI STRUTTURA—FRAME COLORS

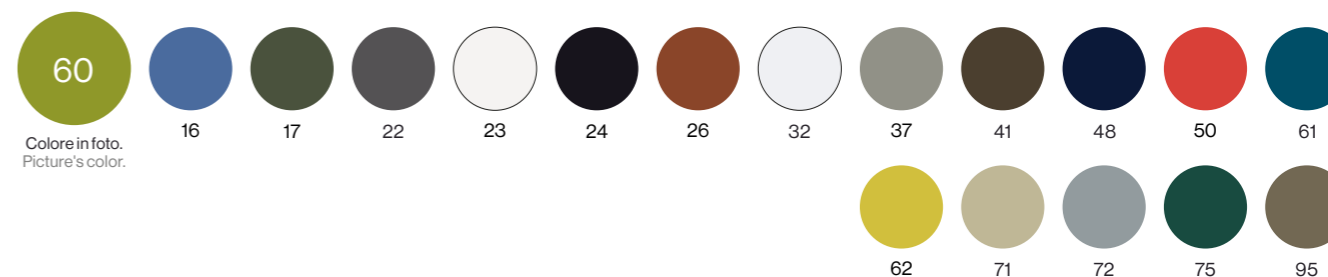

## CUSCINI—CUSHIONS

| Codice/Code<br>Tipologia/Typology | Colori tessuto<br>Fabric colors | Categoria tessuto<br>Fabric category |
|-----------------------------------|---------------------------------|--------------------------------------|
|-----------------------------------|---------------------------------|--------------------------------------|

C/712  
Cuscino magnetico EMU-Tex rettangolare  
Rectangular EMU-Tex magnetic cushion  
x cod. 314  
W40 - D28 - H1,5  
Kg 0,18

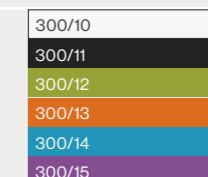

Cuscini Magnetici  
Magnetic Cushions

## PLUS

- Rivetti in acciaio inossidabile che diminuiscono il rischio di corrosione, ruggine e deterioramento da agenti atmosferici.—Stainless steel rivets that reduce the risk of corrosion, rust and deterioration due to weather conditions.
- Cuscino magnetico in abbinamento, stabile nella seduta e facile da rimuovere.  
Magnetic cushion in stable positioning on the seat and easy to remove.

# ATHENA

Design by EMU



Scansiona e scopri i progetti.  
Scan and discover the projects.

3413  
Poltroncina  
Armchair

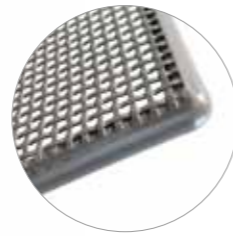

Seduta e schienale in lamiera zincata a caldo forata ad effetto finto intreccio.  
Seat and backrest in hot-dip zincated sheet with simulated woven wire mesh.

3416  
Poltrona  
Lounge chair



Fissaggio cuscino con lacci.  
Cushion fastening with laces.



## PRODOTTI—PRODUCTS

| Codice/Code<br>Tipologia/Typology | Disegno/Drawing | Info |
|-----------------------------------|-----------------|------|
|-----------------------------------|-----------------|------|

3413

Poltroncina  
Armchair  
W59 - D63 - H90  
Kg 6,4

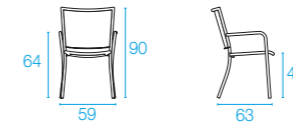

3416

Poltrona  
Lounge chair  
W74 - D78 - H78  
Kg 9,1

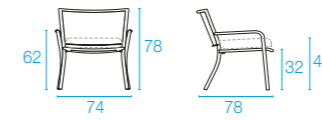

### COLORI STRUTTURA—FRAME COLORS

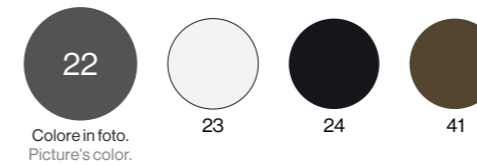

### CUSCINI—CUSHIONS

| Codice/Code<br>Tipologia/Typology  | Colori tessuto<br>Fabric colors                | Categoria tessuto<br>Fabric category |
|--|--|--------------------------------------|
| C/3400<br>Cuscino seduta acrilico<br>Acrylic seat cushion<br>x cod. 3413<br>W40/45 - D44 - H6<br>Kg 0,35   | 700/4<br>700/10<br>700/12*<br>700/13<br>700/14 | Tessuti Basic<br>Basic Fabrics       |
| C/3416<br>Cuscino seduta e schienale acrilico<br>Acrylic seat and back cushion<br>x cod. 3416<br>W50/63 - D60 - H10<br>W54/60 - D44 - H10<br>Kg 2,00 | 700/4<br>700/10<br>700/12*<br>700/13<br>700/14 | Tessuti Basic<br>Basic Fabrics       |

\* Cuscino visibile in foto—Cushion in the picture

## PLUS

- Tubo acciaio cataforizzato e verniciato.—Cataphorised and painted steel pipe.
- Lamiera saldata a proiezione per una maggiore precisione estetica.  
Spot welded sheet for greater aesthetic precision.



Scansiona e scopri i progetti.  
Scan and discover the projects.

3417  
Divano 2 posti  
2-Seater sofa



## PRODOTTI—PRODUCTS



| Codice/Code<br>Tipologia/Typology | Disegno/Drawing | Info |
|-----------------------------------|-----------------|------|
|-----------------------------------|-----------------|------|

3417

Divano 2 posti  
2-seater sofa  
W134 - D78 - H78  
Kg 13,9

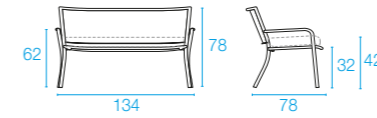

### COLORI STRUTTURA—FRAME COLORS

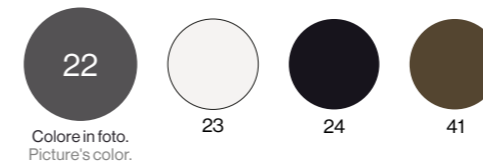

### CUSCINI—CUSHIONS

| Codice/Code<br>Tipologia/Typology  | Colori tessuto<br>Fabric colors                    | Categoria tessuto<br>Fabric category  |
|--|--|---|
| <b>C/3417</b><br>Cuscino seduta e schienale acrilico<br>Acrylic seat and back cushion<br>x cod. 3417<br>W108/122 - D58 - H12<br>W108/122 - D45 - H9<br>Kg 4,00 | <br>700/4<br>700/10<br>700/12*<br>700/13<br>700/14 | Tessuti Basic<br>Basic Fabrics  |
| <b>C/701</b><br>Cuscino decorativo<br>Decorative cushion<br>x cod. 3416, 3417<br>W40 - D40 - H15<br>Kg 0,7   |  | Tessuti Basic (Vedi riepilogo pg. 325)<br>Tessuti Standard (Vedi riepilogo pg. 325)<br>Tessuti Premium (Vedi riepilogo pg. 325)<br>Basic Fabrics (Look at pg. 325)<br>Standard Fabrics (Look at pg. 325)<br>Premium Fabrics (Look at pg. 325) |
| <b>C/705</b><br>Cuscino decorativo<br>Decorative cushion<br>x cod. 3416, 3417<br>W45 - D35 - H15<br>Kg 0,6   |  |   |
| <b>C/706</b><br>Cuscino decorativo<br>Decorative cushion<br>x cod. 3416, 3417<br>W60 - D40 - H20<br>Kg 0,8   |  |   |

\* Cuscino visibile in foto—Cushion in the picture

### ALTRI PRODOTTI IN COLLEZIONE—OTHER COLLECTION'S PRODUCTS



ATHENA  
Cod. 3418  
Tavolo basso  
Coffee table  
PAG. 242

# BREEZE

Design by Chiaramonte—Marin



Scansiona e scopri i progetti.  
Scan and discover the projects.

798  
Sedia  
Chair



Seduta e schienale in EMU-Tex migliorano il comfort nelle varie posizioni in uso. Il telo in EMU-Tex è smontabile.  
EMU-Tex seat and backrest enhance comfort during various positions in use. The EMU-Tex cloth is removable.

799  
Poltroncina  
Armchair



I distanzieri sono disegnati da EMU e proteggono la struttura durante l'impilamento.  
The spacers are designed by EMU and protect the frame when stacked.

## COMBINAZIONI CONSIGLIATE—SUGGESTED MATCHINGS

28



GRACE  
Cod. 285+544  
Tavolo abbattibile 2 posti  
2 seats collapsible table  
PAG. 168



URBAN  
Cod. 096  
Tavolo impilabile 2/4 posti  
2/4 seats stackable table  
PAG. 154



SHINE  
Cod. 254+256  
Tavolo 2/4 posti con piano in HPL  
2/4 seats table with HPL top  
PAG. 184

## PRODOTTI—PRODUCTS



| Codice/Code<br>Tipologia/Typology                           | Disegno/Drawing | Info | TEST            |
|---|-----------------|------|-----------------|
| 798<br>Sedia<br>Chair<br>W57,5 - D54 - H81<br>Kg 4,3        |                 |      | EN581-1/EN581-2 |
| 799<br>Poltroncina<br>Armchair<br>W60 - D54 - H81<br>Kg 4,8 |                 |      | EN581-1/EN581-2 |

## COLORI STRUTTURA/SEDUTA E SCHIENALE—FRAME/SEAT AND BACKREST COLORS

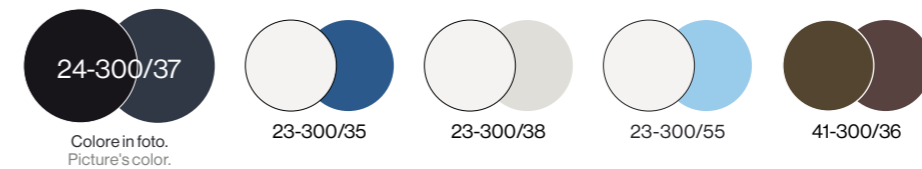

Le immagini dei colori sono a scopo illustrativo. Per vedere la trama degli EMU-Tex, consultare pg. 341.  
All colors images shown are for illustration purposes only. Look at pg. 341 to see the texture of the EMU-Tex.

## PLUS

- I materiali scelti (alluminio ed EMU-Tex) conferiscono al prodotto leggerezza e, al contempo, grande resistenza strutturale.—The chosen materials (aluminium and EMU-Tex) make the product lighter but extremely resistant.
- Tubo estruso di alluminio a sezione ovale.—Extruded aluminium pipe with oval section.

29





Scansiona e scopri i progetti.  
Scan and discover the projects.



146  
Sedia  
Chair

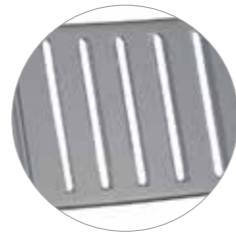

Sedile e schienale in lamiera zincata a caldo che diminuisce il rischio di deterioramento legato agli agenti atmosferici.  
Seat and back in hot-dip zined sheet that reduces the risk of deterioration due to weather conditions.

147  
Poltroncina  
Armchair



Fessure di lamiera imbutita conformi a direttive di sicurezza internazionali.  
Deep-drawn sheet grooves in compliance with international safety regulations.

148  
Sgabello  
Barstool



## PRODOTTI—PRODUCTS

| Codice/Code<br>Tipologia/Typology                           | Disegno/Drawing | Info | TEST             |
|---|-----------------|------|------------------|
| 146<br>Sedia<br>Chair<br>W54 - D62 - H83<br>Kg 7,1          |                 |      | EN581-1/ EN581-2 |
| 147<br>Poltroncina<br>Armchair<br>W56 - D58 - H83<br>Kg 7,2 |                 |      | EN581-1/ EN581-2 |
| 148<br>Sgabello<br>Barstool<br>W54 - D61 - H104<br>Kg 8,8   |                 |      | EN581-1/ EN581-2 |

### COLORI STRUTTURA—FRAME COLORS

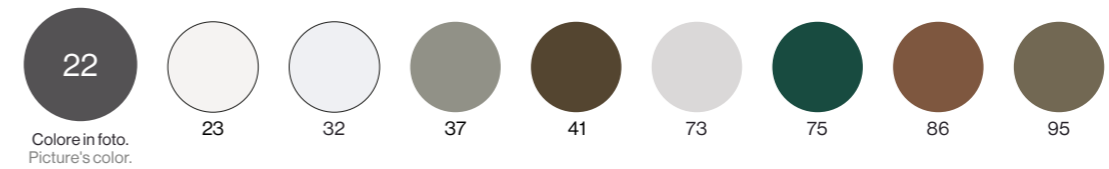

### CUSCINI—CUSHIONS

| Codice/Code<br>Tipologia/Typology  | Colori tessuto<br>Fabric colors | Categoria tessuto<br>Fabric category                  |
|--|---------------------------------|---|
| C/716<br>Cuscino universale poliestere<br>Polyester universal cushion<br>x cod. 146, 147, 148<br>W38 - D40 - H3<br>Kg 0,19 |                                 | Tessuti Cuscini Contract<br>Contract Cushions Fabrics |

\* Cuscino visibile in foto—Cushion in the picture

### COMBINAZIONI CONSIGLIATE—SUGGESTED MATCHINGS



TABLE SYSTEM  
Cod. 1171  
Tavolo bordo squadrato  
5/6 posti  
5/6 seats square border table  
PAG. 198



TABLE SYSTEM  
Cod. 1169  
Tavolo bordo squadrato  
4 posti  
4 seats square border table  
PAG. 196



NOVA  
Cod. 859  
Tavolo quadrato impilabile  
4 posti  
4 seats stackable square table  
PAG. 140

## PLUS

- Sedile e schienali dalle dimensioni generose per un maggiore comfort.  
Large seat and backrest for a greater comfort.
- Cuscino universale: fissaggio antiscivolo.— Universal cushion with non-slip fastening.

# CAPRERA

Design by EMU



Scansiona e scopri i progetti.  
Scan and discover the projects.

930  
Sedia  
Chair



931  
Poltroncina  
Armchair

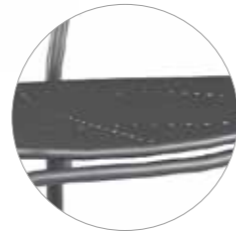

Sedile in lamiera di acciaio zincata a caldo con fori decorativi che facilitano lo scolo dell'acqua.  
Seat made of hot-dip znced steel sheet with decorative holes that allow the drainage of water.

## COMBINAZIONI CONSIGLIATE—SUGGESTED MATCHINGS



PIGALLE  
Cod. 906  
Tavolo tondo 2/4 posti  
2/4 seats round table  
PAG. 144



PIGALLE  
Cod. 907  
Tavolo pieghevole 2/4 posti  
2/4 seats folding table  
PAG. 144



PIGALLE  
Cod. 903  
Tavolo pieghevole 4/6 posti  
4/6 seats folding table  
PAG. 145

## PRODOTTI—PRODUCTS



| Codice/Code<br>Tipologia/Typology | Disegno/Drawing | Info | TEST |
|-----------------------------------|-----------------|------|------|
|-----------------------------------|-----------------|------|------|

930

Sedia  
Chair  
W54 - D54 - H87  
Kg 5,8

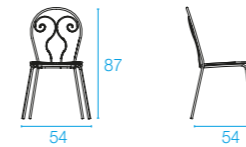

EN581-1/ EN581-2

931

Poltroncina  
Armchair  
W54 - D54 - H87  
Kg 6,6

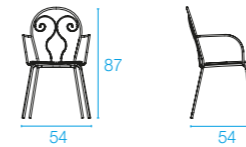

EN581-1/ EN581-2

## COLORI STRUTTURA—FRAME COLORS

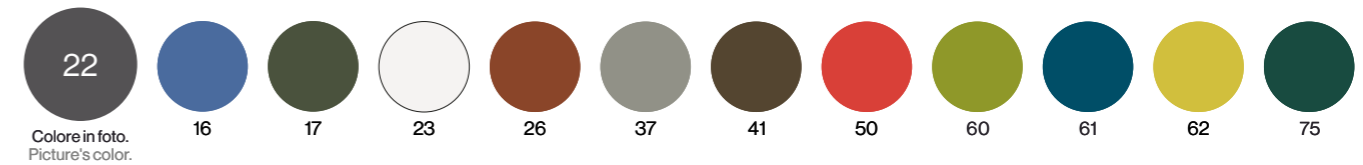

## CUSCINI—CUSHIONS

| Codice/Code<br>Tipologia/Typology | Colori tessuto<br>Fabric colors | Categoria tessuto<br>Fabric category |
|-----------------------------------|---------------------------------|--------------------------------------|
|-----------------------------------|---------------------------------|--------------------------------------|

C/711

Cuscino magnetico EMU-Tex tondo  
EMU-Tex round magnetic cushion  
x cod. 930, 931  
ø38 - H1,5  
Kg 0,17



|         |
|---------|
| 300/10* |
| 300/11  |
| 300/12  |

Cuscini Magnetici  
Magnetic Cushions

C/704

Cuscino EMU acrilico tondo  
Acrylic EMU round cushion  
x cod. 930, 931  
ø38,5 - H2  
Kg 0,11



|        |
|--------|
| 700/4  |
| 700/10 |
| 700/12 |
| 700/13 |
| 700/14 |

Tessuti Basic  
Basic Fabrics

\* Cuscino visibile in foto—Cushion in the picture

# CAROUSEL

Design by Sebastian Herkner



Scansiona e scopri i progetti.  
Scan and discover the projects.

1210  
Poltroncina Alu-tex  
Alu-tex armchair



Versione in tessuto tecnico di poliestere e imbottitura in moltoprene, con cui viene realizzato un cuscino sedile e uno schienale autoportante. Tessuto idrorepellente e antimacchia.  
Version in technical polyester fabric and foam padding, with which a seat cushion and a self-supporting backrest are made. Water and stains repellent fabric.



## PRODOTTI—PRODUCTS

| Codice/Code<br>Tipologia/Typology | Disegno/Drawing | Info |
|-----------------------------------|-----------------|------|
|-----------------------------------|-----------------|------|

1210  
Poltroncina Alu-tex  
Alu-tex Armchair  
W61,5 - D54 - H78  
Kg 7,2

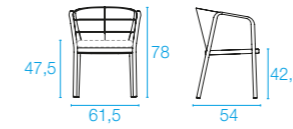

### COLORI STRUTTURA/SCHIENALE—FRAME/BACK COLORS

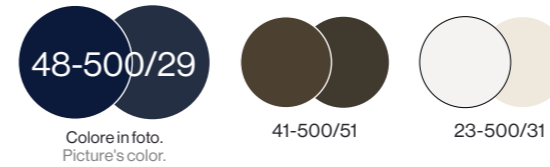

## CUSCINI—CUSHIONS

| Codice/Code<br>Tipologia/Typology   | Colori tessuto<br>Fabric colors   | Categoria tessuto<br>Fabric category                  |
|---|---|---|
| C/1210<br>Cuscino seduta poliestere<br>Polyester seat cushion<br>x cod. 1210<br>W47 - D44 - H5<br>Kg 0,40 | <div style="display: flex; gap: 5px;"> <div style="background-color: #1a3d54; width: 20px; height: 10px;"></div> 500/29*                     <div style="background-color: #c0c0c0; width: 20px; height: 10px;"></div> 500/31                     <div style="background-color: #4b4b4b; width: 20px; height: 10px;"></div> 500/51                 </div> | Tessuti Cuscini Contract<br>Contract Cushions Fabrics |



\* Cuscino visibile in foto—Cushion in the picture

# CAROUSEL

Design by Sebastian Herkner



Scansiona e scopri i progetti.  
Scan and discover the projects.

**1212**  
Poltroncina  
Alu-corda  
intreccio fitto  
Alu-thick  
twist rope  
armchair



23-12  
Colore in foto.  
Picture's color.

\* Cuscino visibile in foto 900/77 Grigio trama stretta—Cushion in the picture 900/77 Small weft grey

**1213**  
Poltroncina  
Alu-corda  
intreccio quadrato  
Alu-square  
twist rope  
armchair



41-19  
Colore in foto.  
Picture's color.

\* Cuscino visibile in foto 900/79 Blu trama stretta—Cushion in the picture 900/79 Small weft blue

**1214**  
Poltroncina  
Alu-corda  
piatta  
Alu-flat rope  
armchair



73-18  
Colore in foto.  
Picture's color.

\* Cuscino visibile in foto 900/71 Bianco trama stretta—Cushion in the picture 900/71 Small weft white

## PRODOTTI—PRODUCTS



| Codice/Code<br>Tipologia/Typology  | Disegno/Drawing | Info |
|--|-----------------|------|
| <b>1212</b><br>Poltroncina Alu-corda intreccio fitto<br>Alu-thick twist rope armchair<br>W61,5 - D52 - H77<br>Kg 9,5     |                 |      |
| <b>1213</b><br>Poltroncina Alu-corda intreccio quadrato<br>Alu-square twist rope armchair<br>W61,5 - D52 - H77<br>Kg 8,1 |                 |      |
| <b>1214</b><br>Poltroncina Alu-corda piatta<br>Alu-flat rope armchair<br>W61,5 - D52 - H77<br>Kg 8,3                     |                 |      |

### COLORI STRUTTURA/SCHIENALE—FRAME/BACK COLORS

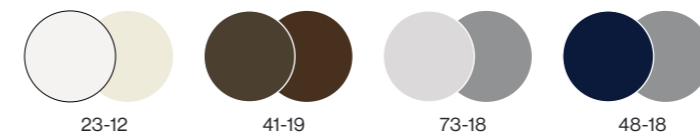

### CUSCINI—CUSHIONS

| Codice/Code<br>Tipologia/Typology   | Colori tessuto<br>Fabric colors | Categoria tessuto<br>Fabric category  |
|---|---------------------------------|---|
| <b>C/1211</b><br>Cuscino seduta<br>Seat cushion<br>x cod. 1212, 1213, 1214<br>W47 - D44 - H7<br>Kg 0,52 |                                 | Tessuti Basic (Vedi riepilogo pg. 42)<br>Tessuti Standard (Vedi riepilogo pg. 42)*<br>Tessuti Premium (Vedi riepilogo pg. 42)<br>Basic Fabrics (Look at pg. 42)<br>Standard Fabrics (Look at pg. 42)*<br>Premium Fabrics (Look at pg. 42) |
| <b>FC/1210</b><br>Cover x cod. 1210, 1212, 1213, 1214   |                                 |   |

### PLUS

- La poltroncina dining è disponibile in tre versioni di intreccio.  
The dining armchair is available in three versions of weaving.
- Il sedile, costituito da una lamiera imbutita in lega di alluminio, è fissato alla struttura di alluminio tramite rivettatura.—The deep-drawn seat in aluminium alloy is fixed to the aluminium frame by riveting.
- La struttura dello schienale è in acciaio cataforizzato ed è il supporto su cui sono realizzati i vari intrecci decorativi.—The cataphorised steel frame of the backrest is the support of the various decorative weaves.
- Tutte le saldature sono particolarmente curate e ripulite con un processo di molatura che conferisce un'estetica del dettaglio curata e definita.—All the welds are extremely even through a grinding process which gives a more defined aesthetic detail.
- Corda idrorepellente.—Water-repellent rope.

# CAROUSEL

Design by Sebastian Herkner



Scansiona e scopri i progetti.  
Scan and discover the projects.

**1216**  
Poltrona  
Alu-corda  
intreccio fitto  
Alu-thick  
twist rope  
lounge chair



23-12  
Colore in foto.  
Picture's color.

\* Cuscino visibile in foto 900/77 Grigio trama stretta—Cushion in the picture 900/77 Small weft grey

**1217**  
Poltrona  
Alu-corda  
intreccio quadrato  
Alu-square  
twist rope  
lounge chair



41-19  
Colore in foto.  
Picture's color.

\* Cuscino visibile in foto 900/79 Blu trama stretta—Cushion in the picture 900/79 Small weft blue

**1218**  
Poltrona  
Alu-corda  
piatta  
Alu-flat rope  
lounge chair



73-18  
Colore in foto.  
Picture's color.

\* Cuscino visibile in foto 900/71 Bianco trama stretta—Cushion in the picture 900/71 Small weft white



Il tubolare di alluminio della struttura a cavalletto è modellato tridimensionalmente così da offrire un raffinato design svolgendo al tempo stesso, sia la funzione portante che di comodo bracciolo. Saldatura a TIG delle varie componenti che conferisce maggiore resistenza ed un miglior livello estetico.  
The aluminium pipe of the easel is three-dimensionally modeled and offers an elegant design acting as structural component as well as comfortable armrest. TIG welding of the elements for a better resistance and aesthetic.

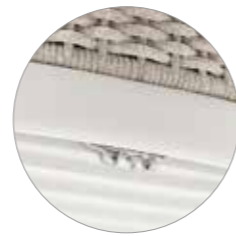

Fissaggio cuscino con elastico e gancetti.  
Fastening of the cushion with rubber band and hooks.

## PRODOTTI—PRODUCTS

| Codice/Code<br>Tipologia/Typology | Disegno/Drawing | Info |
|-----------------------------------|-----------------|------|
|-----------------------------------|-----------------|------|

**1216**  
Poltrona Alu-corda intreccio fitto  
Alu-thick twist rope lounge chair  
W74 - D73 - H73,5  
Kg 13,8

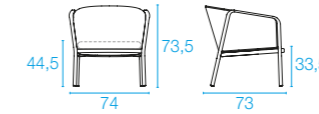

**1217**  
Poltrona Alu-corda intreccio quadrato  
Alu-square twist rope lounge chair  
W74 - D73 - H73,5  
Kg 11,4

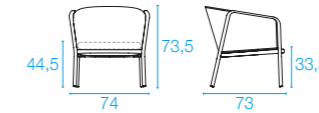

**1218**  
Poltrona Alu-corda piatta  
Alu-flat rope lounge chair  
W74 - D73 - H73,5  
Kg 10,6

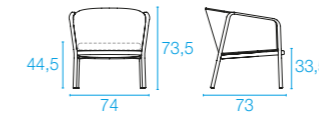

### COLORI STRUTTURA/SCHIENALE—FRAME/BACK COLORS

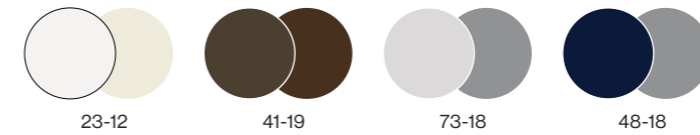

### CUSCINI—CUSHIONS

| Codice/Code<br>Tipologia/Typology   | Colori tessuto<br>Fabric colors | Categoria tessuto<br>Fabric category  |
|---|---------------------------------|---|
| <b>C/1215</b><br>Cuscino seduta—Seat cushion<br>x cod. 1216, 1217, 1218<br>W58 - D57 - H11 Kg 1,1                   |                                 | Tessuti Basic (Vedi riepilogo pg. 42)<br>Tessuti Standard (Vedi riepilogo pg. 42)*<br>Tessuti Premium (Vedi riepilogo pg. 42)<br>Basic Fabrics (Look at pg. 42)<br>Standard Fabrics (Look at pg. 42)*<br>Premium Fabrics (Look at pg. 42)     |
| <b>C/701</b><br>Cuscino decorativo<br>Decorative cushion<br>x cod. 1216, 1217, 1218, 1219<br>W40 - D40 - H15 Kg 0,7 |                                 | Tessuti Basic (Vedi riepilogo pg. 325)<br>Tessuti Standard (Vedi riepilogo pg. 325)<br>Tessuti Premium (Vedi riepilogo pg. 325)<br>Basic Fabrics (Look at pg. 325)<br>Standard Fabrics (Look at pg. 325)<br>Premium Fabrics (Look at pg. 325) |
| <b>C/705</b><br>Cuscino decorativo<br>Decorative cushion<br>x cod. 1216, 1217, 1218, 1219<br>W45 - D35 - H15 Kg 0,6 |                                 |   |
| <b>C/706</b><br>Cuscino decorativo<br>Decorative cushion<br>x cod. 1216, 1217, 1218, 1219<br>W60 - D40 - H20 Kg 0,8 |                                 |   |
| <b>FC/1216</b><br>Cover x cod. 1216, 1217, 1218   |                                 |   |

# CAROUSEL

Design by Sebastian Herkner



Scansiona e scopri i progetti.  
Scan and discover the projects.

**1219**  
Divano  
Alu-corda  
intreccio fitto  
Alu-thick  
twist rope  
sofa



23-12  
Colore in foto.  
Picture's color.

\*Cuscino visibile in foto 900/77 Grigio trama stretta—Cushion in the picture 900/77 Small weft grey

**1222**  
Pouf



23  
Colore in foto.  
Picture's color.

\*Cuscino visibile in foto 900/77 Grigio trama stretta—Cushion in the picture 900/77 Small weft grey

## ALTRI PRODOTTI IN COLLEZIONE—OTHER COLLECTION'S PRODUCTS

40



CAROUSEL  
Cod. 1223  
Tavolo basso quadrato Alu-corda intreccio fitto  
Alu-thick twist rope square coffee table  
PAG. 246



CAROUSEL  
Cod. 1224  
Tavolo basso rettangolare Alu-corda intreccio fitto  
Alu-thick twist rope rectangular coffee table  
PAG. 246

## PRODOTTI—PRODUCTS



| Codice/Code<br>Tipologia/Typology | Disegno/Drawing | Info |
|-----------------------------------|-----------------|------|
|-----------------------------------|-----------------|------|

**1219**

Divano Alu-corda intreccio fitto  
Alu-thick twist rope sofa  
W155 - D71 - H73  
Kg 22,3

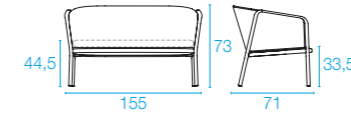

**1222**

Pouf  
W62 - D44,5 - H33  
Kg 4,0



### COLORI STRUTTURA/SCHIENALE X COD. 1219—FRAME/BACK COLORS X COD. 1219

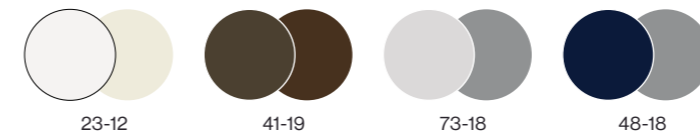

### COLORI STRUTTURA X COD. 1222—FRAME COLORS X COD. 1222

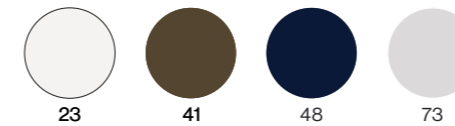

## CUSCINI—CUSHIONS

| Codice/Code<br>Tipologia/Typology  | Colori tessuto<br>Fabric colors | Categoria tessuto<br>Fabric category  |
|--|---------------------------------|---|
| <b>C/1219</b><br>Cuscino seduta<br>Seat cushion<br>x cod. 1219<br>W145 - D62 - H11<br>Kg 2,8 |                                 | Tessuti Basic (Vedi riepilogo pg. 325)<br>Tessuti Standard (Vedi riepilogo pg. 325)*<br>Tessuti Premium (Vedi riepilogo pg. 325)<br>Basic Fabrics (Look at pg. 325)<br>Standard Fabrics (Look at pg. 325)*<br>Premium Fabrics (Look at pg. 325) |
| <b>C/1222</b><br>Cuscino seduta<br>Seat cushion<br>x cod. 1222<br>W53 - D44 - H11<br>Kg 0,8  |                                 |   |
| <b>FC/1219</b><br>Cover x cod. 1219  |                                 | Vedi pg. 42<br>Look at pg. 42   |

## PLUS

- Il divano è disponibile solo nella versione intreccio fitto.—The sofa is only available in the thick twist version.
- Corda idrorepellente.—Water-repellent rope.

41



## TESSUTI CUSCINI—CUSHION FABRICS C/1211 - C/1215 - C/1219 - C/1222

Composizione/Categoria tessuti  
Composition/Fabrics category

Colori  
Colors

### TESSUTI BASIC—BASIC FABRICS

|                  |        |
|------------------|--------|
| Acrilico—Acrylic | 700/4  |
|                  | 700/10 |
|                  | 700/12 |
|                  | 700/13 |
|                  | 700/14 |

### TESSUTI STANDARD—STANDARD FABRICS

|  |        |
|--|--------|
| 85% Polipropilene, 15% Poliestere—85% Polypropylene, 15% Polyester | 900/01 |
|  | 900/02 |
|  | 900/03 |
|  | 900/05 |
|  | 900/06 |
|  | 900/07 |
|  | 900/08 |
|  | 900/09 |
|  | 900/13 |
|  | 900/14 |
|  | 900/17 |
|  | 900/18 |
|  | 900/71 |
|  | 900/75 |
| 900/77   |        |
| 900/79   |        |

### TESSUTI PREMIUM—PREMIUM FABRICS

|  |        |   |
|--|--------|---|
| CAT. D<br>Visitare il nostro sito web <a href="http://www.emu.it">www.emu.it</a> —Visit our website <a href="http://www.emu.it">www.emu.it</a> | 600/08 | Ⓢ |
|  | 600/09 | Ⓢ |
|  | 600/15 | Ⓢ |
|  | 600/17 | Ⓢ |
|  | 600/24 | Ⓢ |
| CAT. C<br>Visitare il nostro sito web <a href="http://www.emu.it">www.emu.it</a> —Visit our website <a href="http://www.emu.it">www.emu.it</a> | 600/26 | Ⓢ |
|  | 600/27 | Ⓢ |
|  | 600/28 | Ⓢ |
|  | 900/16 | Ⓢ |
|  | 900/19 | Ⓢ |
| CAT. B<br>Visitare il nostro sito web <a href="http://www.emu.it">www.emu.it</a> —Visit our website <a href="http://www.emu.it">www.emu.it</a> | 600/02 | Ⓢ |
|  | 600/07 | Ⓢ |
|  | 600/14 | Ⓢ |
|  | 600/16 | Ⓢ |
|  | 600/18 | Ⓢ |
| CAT. A<br>Visitare il nostro sito web <a href="http://www.emu.it">www.emu.it</a> —Visit our website <a href="http://www.emu.it">www.emu.it</a> | 600/03 | Ⓢ |
|  | 600/10 | Ⓢ |
|  | 600/11 | Ⓢ |
|  | 600/12 | Ⓢ |
|  | 600/22 | Ⓢ |
| CAT. A   | 600/04 | Ⓢ |
|  | 600/06 | Ⓢ |
|  | 600/21 | Ⓢ |

### CON TESSUTO CLIENTE—WITH CUSTOMER'S FABRIC

FABBISOGNO TESSUTO (cm)—FABRIC REQUIRED (cm) C/1211 132x60, C/1215 132x90, C/1219 132x190, C/1222 132x70

Ⓢ La caratteristica FLAME RETARDANT indica una capacità di resistenza contro fonti di calore o fuoco.  
Per conoscere nel dettaglio tale caratteristica si prega di far riferimento alle schede tecniche presenti nell'area riservata del sito [www.emu.it](http://www.emu.it)  
The FLAME RETARDANT characteristic is an indication of chemical resistance against sources of heat or fire.  
To find out more about this feature, please refer to the technical data sheets in the reserved area of the website [www.emu.it](http://www.emu.it)





Scansiona e scopri i progetti.  
Scan and discover the projects.



974  
Sedia regista  
Director's chair



Apertura pieghevole con bloccaggio di sicurezza in acciaio inox lucido.  
Folding opening with polished stainless steel safety locking.



La sedia piegata rimane in piedi da sola occupando pochissimo spazio, ottimale per riporla.  
When folded, the chair is self-standing and ideal for storage by taking few space.

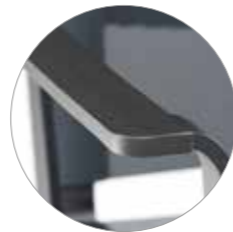

Bracciolo effetto legno in ABS.  
Armrest in ABS look like wood.

975  
Pouf / poggiatesta  
pieghevole  
Folding  
pouf / foot stool



Doppia cucitura del telo sedile e schienale per una maggiore resistenza alle sollecitazioni in uso.  
Double stitching of the seat and backrest cloth for a greater resistance to stress in use.

## PRODOTTI—PRODUCTS

| Codice/Code<br>Tipologia/Typology | Disegno/Drawing | Info | TEST |
|-----------------------------------|-----------------|------|------|
|-----------------------------------|-----------------|------|------|

|   |  |  |                   |
|---|--|--|-------------------|
| 974<br>Sedia regista<br>Director's chair<br>W64 - D50 - H85<br>Kg 5,7 |  |  | EN581-1 / EN581-2 |
|---|--|--|-------------------|

|  |  |  |                   |
|--|--|--|-------------------|
| 975<br>Pouf / poggiatesta<br>pieghevole<br>Folding<br>pouf / foot stool<br>W42 - D48 - H38<br>Kg 2,9 |  |  | EN581-1 / EN581-2 |
|--|--|--|-------------------|

### COLORI STRUTTURA/SEDUTA E SCHIENALE/BRACCIOLI X COD. 974 FRAME/SEAT AND BACKREST/ARMRESTS COLORS X COD. 974

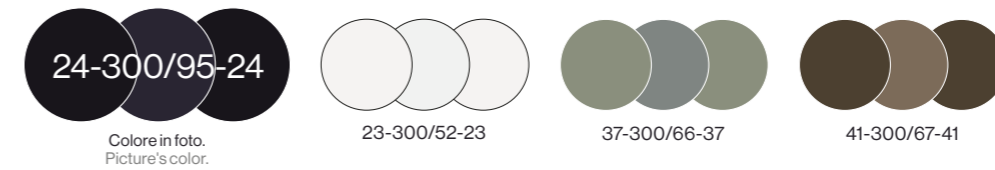

### COLORI STRUTTURA/SEDUTA X COD. 975 — FRAME/SEAT COLORS X COD. 975



Le immagini dei colori sono a scopo illustrativo. Per vedere la trama degli EMU-Tex, consultare pg. 341.  
All colors images shown are for illustration purposes only. Look at pg. 341 to see the texture of the EMU-Tex.

### COMBINAZIONI CONSIGLIATE—SUGGESTED MATCHINGS



GRACE  
Cod. 285+288  
Tavolo bordo quadrato  
abbattibile 2 posti  
2 seats collapsible square  
border table  
PAG. 168



SHINE  
Cod. 254+256  
Tavolo 2/4 posti con piano  
in HPL  
2/4 seats table with HPL top  
PAG. 184



ROUND  
Cod. 473  
Tavolo quadrato 2/4 posti  
2/4 seats square table  
PAG. 180

## PLUS

• Struttura in piatto di alluminio modellato che crea una piacevole forma estetica e conferisce grande leggerezza.  
The flat aluminium pipe of the frame is shaped for a pleasant look and great lightness in terms of weight.





Scansiona e scopri i progetti.  
Scan and discover the projects.



1200  
Sedia  
Chair



Saldatura ad ottone dei tondini decorativi e dei tubi dello schienale per un migliore effetto estetico.  
Brass welding of decorative bars and backrest pipes for a better aesthetic look.

1201  
Poltroncina  
schienale  
basso  
Short back  
armchair

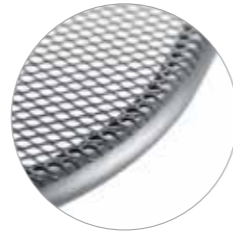

La seduta in lamiera zincata a caldo è saldata a proiezione al tubo di struttura.  
The hot-dip zincated sheet of the seat is spot welded to the frame pipe.

1202  
Poltroncina  
schienale alto  
Tall back  
armchair



Fissaggio cuscino con lacci.  
Fastening of the cushion with laces.

## PRODOTTI—PRODUCTS

| Codice/Code<br>Tipologia/Typology  | Disegno/Drawing | Info | TEST             |
|--|-----------------|------|------------------|
| 1200<br>Sedia<br>Chair<br>W57 - D59,5 - H83,5<br>Kg 6,2                                      |                 |      | EN581-1/ EN581-2 |
| 1201<br>Poltroncina<br>schienale basso<br>Short back armchair<br>W57 - D59 - H83,5<br>Kg 6,2 |                 |      |                  |
| 1202<br>Poltroncina<br>schienale alto<br>Tall back armchair<br>W57 - D62 - H95<br>Kg 6,8     |                 |      | EN581-1/ EN581-2 |

### COLORI STRUTTURA—FRAME COLORS

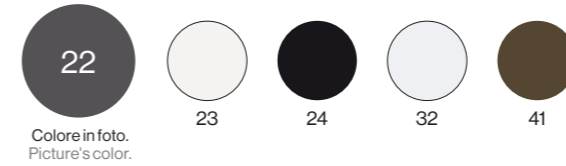

### CUSCINI—CUSHIONS

| Codice/Code<br>Tipologia/Typology   | Colori tessuto<br>Fabric colors | Categoria tessuto<br>Fabric category   |
|---|---------------------------------|--|
| C/1200<br>Cuscino seduta—Seat cushion<br>x cod. 1200, 1201, 1202<br>W52 - D48 - H7<br>Kg 0,6    |                                 | Vedi pg. 50<br>Look at pg. 50<br><br>Tessuti Basic (Vedi riepilogo pg. 50)<br>Tessuti Standard (Vedi riepilogo pg. 50)*<br>Tessuti Premium (Vedi riepilogo pg. 50)<br>Basic Fabrics (Look at pg. 50)<br>Standard Fabrics (Look at pg. 50)*<br>Premium Fabrics (Look at pg. 50) |
| C/1201<br>Cuscino schienale—Back cushion<br>x cod. 1200, 1201, 1202<br>W32 - D35 - H2<br>Kg 0,2 |                                 |  |

\*Cuscino visibile in foto 900/71 Bianco trama stretta—Cushion in the picture 900/71 Small weft white



Scansiona e scopri i progetti.  
Scan and discover the projects.

1204  
Poltrona  
Lounge chair



1205  
Divano  
Sofa



L'intreccio dei tondini saldati a proiezione è un elemento caratterizzante il design classico del prodotto.  
The weave of spot welded bars is one of the specific features of this piece of classic design.

\* Cuscino visibile in foto 900/71 Bianco trama stretta—Cushion in the picture 900/71 Small weft white

\* Cuscino visibile in foto 900/71 Bianco trama stretta—Cushion in the picture 900/71 Small weft white

## ALTRI PRODOTTI IN COLLEZIONE—OTHER COLLECTION'S PRODUCTS



COMO  
Cod. 494+1207  
Tavolo tondo 6/7 posti  
6/7 seats round table  
PAG. 162



COMO  
Cod. 1208  
Tavolo basso  
Coffee table  
PAG. 248

## PRODOTTI—PRODUCTS



| Codice/Code<br>Tipologia/Typology | Disegno/Drawing | Info | TEST |
|-----------------------------------|-----------------|------|------|
|-----------------------------------|-----------------|------|------|

|   |  |  |                 |
|---|--|--|-----------------|
| 1204<br>Poltrona<br>Lounge chair<br>W78 - D76 - H79<br>Kg 8,8 |  |  | EN581-1/EN581-2 |
|---|--|--|-----------------|

|   |  |  |                 |
|---|--|--|-----------------|
| 1205<br>Divano<br>Sofa<br>W155 - D76 - H79<br>Kg 16,5 |  |  | EN581-1/EN581-2 |
|---|--|--|-----------------|

### COLORI STRUTTURA—FRAME COLORS

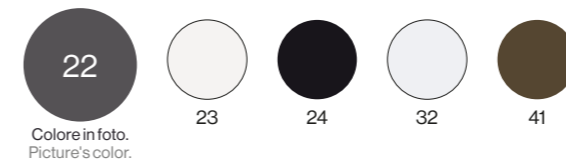

### CUSCINI—CUSHIONS

| Codice/Code<br>Tipologia/Typology   | Colori tessuto<br>Fabric colors | Categoria tessuto<br>Fabric category |
|---|---------------------------------|--------------------------------------|
| C/1204<br>Cuscino seduta—Seat cushion<br>x cod. 1204<br>W73 - D66 - H9<br>Kg 1,5              |                                 | Vedi pg. 50<br>Look at pg. 50        |
| C/1205<br>Cuscino seduta—Seat cushion<br>x cod. 1205<br>W148 - D67 - H9<br>Kg 3,1             |                                 |                                      |
| C/1206<br>Cuscino schienale—Back cushion<br>x cod. 1204, 1205<br>W58 - D40 - H18<br>Kg 1,0    |                                 |                                      |
| C/701<br>Cuscino decorativo—Decorative cushion<br>x cod. 1204, 1205<br>W40 - D40 - H15 Kg 0,7 |                                 | Vedi pg. 325<br>Look at pg. 325      |
| C/705<br>Cuscino decorativo—Decorative cushion<br>x cod. 1204, 1205<br>W45 - D35 - H15 Kg 0,6 |                                 |                                      |
| C/706<br>Cuscino decorativo—Decorative cushion<br>x cod. 1204, 1205<br>W60 - D40 - H20 Kg 0,8 |                                 |                                      |

Tessuti Basic (Vedi riepilogo pg. 50)  
Tessuti Standard (Vedi riepilogo pg. 50)\*  
Tessuti Premium (Vedi riepilogo pg. 50)  
Basic Fabrics (Look at pg. 50)  
Standard Fabrics (Look at pg. 50)\*  
Premium Fabrics (Look at pg. 50)

Tessuti Basic (Vedi riepilogo pg. 325)  
Tessuti Standard (Vedi riepilogo pg. 325)  
Tessuti Premium (Vedi riepilogo pg. 325)  
Basic Fabrics (Look at pg. 325)  
Standard Fabrics (Look at pg. 325)  
Premium Fabrics (Look at pg. 325)



Scansiona e scopri i progetti.  
Scan and discover the projects.

## TESSUTI CUSCINI—CUSHION FABRICS C/1200 - C/1201 - C/1204 - C/1205 - C/1206

Composizione/Categoria tessuti  
Composition/Fabrics category

Colori  
Colors

### TESSUTI BASIC—BASIC FABRICS

|                  |        |
|------------------|--------|
| Acrilico—Acrylic | 700/4  |
|                  | 700/10 |
|                  | 700/12 |
|                  | 700/13 |
|                  | 700/14 |

### TESSUTI STANDARD—STANDARD FABRICS

|  |        |
|--|--------|
| 85% Polipropilene, 15% Poliestere—85% Polypropylene, 15% Polyester | 900/01 |
|  | 900/02 |
|  | 900/03 |
|  | 900/05 |
|  | 900/06 |
|  | 900/07 |
|  | 900/08 |
|  | 900/09 |
|  | 900/13 |
|  | 900/14 |
| Acrilico—Acrylic   | 900/17 |
|  | 900/18 |
|  | 900/71 |
| Polipropilene—Polypropylene  | 900/75 |
|  | 900/77 |
|  | 900/79 |

### TESSUTI PREMIUM—PREMIUM FABRICS

|  |        |   |
|--|--------|---|
| CAT. D<br>Visitare il nostro sito web <a href="http://www.emu.it">www.emu.it</a> —Visit our website <a href="http://www.emu.it">www.emu.it</a> | 600/08 | Ⓢ |
|  | 600/09 | Ⓢ |
|  | 600/15 | Ⓢ |
|  | 600/17 | Ⓢ |
|  | 600/24 | Ⓢ |
| CAT. C<br>Visitare il nostro sito web <a href="http://www.emu.it">www.emu.it</a> —Visit our website <a href="http://www.emu.it">www.emu.it</a> | 600/25 | Ⓢ |
|  | 600/26 | Ⓢ |
|  | 600/27 | Ⓢ |
|  | 600/28 | Ⓢ |
| CAT. B<br>Visitare il nostro sito web <a href="http://www.emu.it">www.emu.it</a> —Visit our website <a href="http://www.emu.it">www.emu.it</a> | 900/16 | Ⓢ |
|  | 900/19 | Ⓢ |
|  | 600/02 | Ⓢ |
|  | 600/07 | Ⓢ |
| CAT. A<br>Visitare il nostro sito web <a href="http://www.emu.it">www.emu.it</a> —Visit our website <a href="http://www.emu.it">www.emu.it</a> | 600/14 | Ⓢ |
|  | 600/16 | Ⓢ |
|  | 600/18 | Ⓢ |
|  | 600/03 | Ⓢ |
|  | 600/10 | Ⓢ |
|  | 600/11 | Ⓢ |
|  | 600/12 | Ⓢ |
|  | 600/22 | Ⓢ |
|  | 600/04 | Ⓢ |
|  | 600/06 | Ⓢ |
|  | 600/21 | Ⓢ |

### CON TESSUTO CLIENTE—WITH CUSTOMER'S FABRIC

FABBISOGNO TESSUTO (cm)—FABRIC REQUIRED (cm) C/1200 132x80, C/1201 132x54, C/1204 132x180, C/1205 132x250, C/1206 132x80

Ⓢ La caratteristica FLAME RETARDANT indica una capacità di resistenza contro fonti di calore o fuoco.  
Per conoscere nel dettaglio tale caratteristica si prega di far riferimento alle schede tecniche presenti nell'area riservata del sito [www.emu.it](http://www.emu.it)  
The FLAME RETARDANT characteristic is an indication of chemical resistance against sources of heat or fire.  
To find out more about this feature, please refer to the technical data sheets in the reserved area of the website [www.emu.it](http://www.emu.it)





Scansiona e scopri i progetti.  
Scan and discover the projects.



521  
Sedia  
Chair

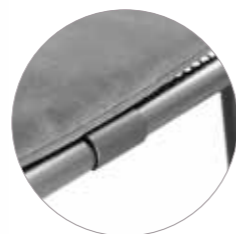

Cuscino C/522 con bloccaggi laterali.  
C/522 cushion with side locks.

522  
Poltroncina  
Armchair

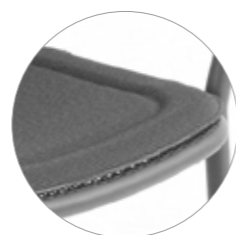

Cuscino C/707 antiscivolo in tessuto esterno idrorepellente.  
C/707 non-slip cushion with external water-repellent fabric.

523  
Sgabello  
Barstool

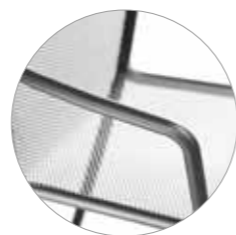

Il tubo di struttura assolve contemporaneamente la funzione portante di schienale, bracciolo e gambe anteriori.  
The frame pipe simultaneously acts as load-bearing for backrest, armrest and front legs.

## PRODOTTI—PRODUCTS

| Codice/Code<br>Tipologia/Typology                           | Disegno/Drawing | Info | TEST            |
|---|-----------------|------|-----------------|
| 521<br>Sedia<br>Chair<br>W53 - D54 - H77<br>Kg 4,8          |                 |      | EN581-1/EN581-2 |
| 522<br>Poltroncina<br>Armchair<br>W60 - D55 - H77<br>Kg 5,8 |                 |      | EN581-1/EN581-2 |
| 523<br>Sgabello<br>Barstool<br>W50 - D51 - H103<br>Kg 6,0   |                 |      |                 |

### COLORI STRUTTURA X COD. 521, 522—FRAME COLORS X COD. 521, 522

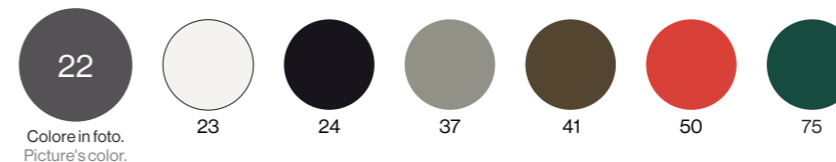

### COLORI STRUTTURA X COD. 523—FRAME COLORS X COD. 523

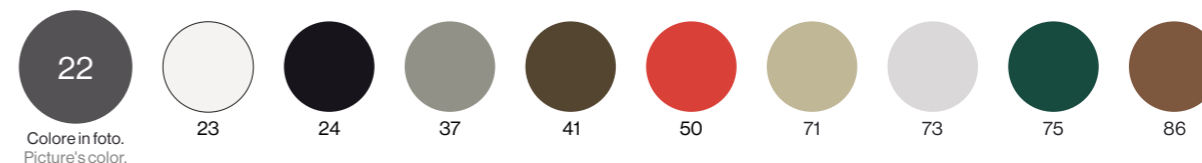

## CUSCINI—CUSHIONS

| Codice/Code<br>Tipologia/Typology  | Colori tessuto<br>Fabric colors                     | Categoria tessuto<br>Fabric category                  |
|--|---|---|
| C/521<br>Cuscino seduta acrilico—Acrylic seat cushion<br>x cod. 521, 522<br>W39/42 - D38 - H2 Kg 0,18              | <br>700/4<br>700/12<br>700/13<br>700/14             | Tessuti Basic<br>Basic Fabrics                        |
| C/522<br>Cuscino seduta poliesteri—Polyester seat cushion<br>x cod. 521, 522<br>W44 - D38 - H2 Kg 0,23             | <br>500/28<br>500/29<br>500/30*<br>500/31<br>500/51 | Tessuti Cuscini Contract<br>Contract Cushions Fabrics |
| C/707<br>Cuscino universale poliesteri<br>Polyester universal cushion<br>x cod. 521, 522<br>W44 - D38 - H2 Kg 0,23 | <br>500/28<br>500/29<br>500/30<br>500/31<br>500/51  | Tessuti Cuscini Contract<br>Contract Cushions Fabrics |

\* Cuscino visibile in foto—Cushion in the picture

## PLUS

• Cuscino in tessuto acrilico C/521, sfoderabile, con sistema di fissaggio in velcro.  
C/521 cushion in acrylic fabric, cover removable, with velcro fastening system.

# DARWIN

Design by Lucidi—Pevere



Scansiona e scopri i progetti.  
Scan and discover the projects.



524  
Poltrona  
Lounge chair

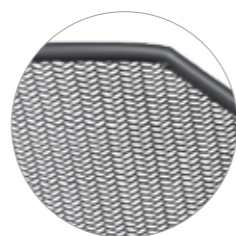

Lamiera stirata prezinata a caldo per una maggiore resistenza contro gli agenti atmosferici, utilizzata ad hoc per la collezione Darwin.  
The pre hot-zincated expanded sheet, for a great resistance to weather conditions, is specific for Darwin collection.

527  
Divano  
Sofa



## PRODOTTI—PRODUCTS

| Codice/Code<br>Tipologia/Typology | Disegno/Drawing | Info | TEST |
|-----------------------------------|-----------------|------|------|
|-----------------------------------|-----------------|------|------|

**524**  
Poltrona  
Lounge chair  
W77 - D73 - H75  
Kg 6,7

EN581-1/ EN581-2

**527**  
Divano  
Sofa  
W140 - D73 - H75  
Kg 13,3

EN581-1/ EN581-2

### COLORI STRUTTURA—FRAME COLORS

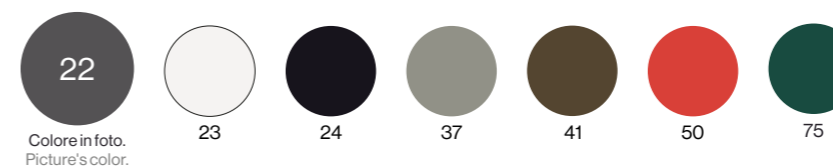

### CUSCINI—CUSHIONS

| Codice/Code<br>Tipologia/Typology   | Colori tessuto<br>Fabric colors   | Categoria tessuto<br>Fabric category |        |        |         |                                |
|---|---|--------------------------------------|--------|--------|---------|--------------------------------|
| <b>C/524</b><br>Cuscino seduta acrilico<br>Acrylic seat cushion<br>x cod. 524<br>W43/58 - D49 - H2<br>Kg 0,35   | <table border="1"> <tr><td>700/4</td></tr> <tr><td>700/12</td></tr> <tr><td>700/13</td></tr> <tr><td>700/14*</td></tr> </table> | 700/4                                | 700/12 | 700/13 | 700/14* | Tessuti Basic<br>Basic Fabrics |
| 700/4   |   |                                      |        |        |         |                                |
| 700/12  |   |                                      |        |        |         |                                |
| 700/13  |   |                                      |        |        |         |                                |
| 700/14*   |   |                                      |        |        |         |                                |
| <b>C/527</b><br>Cuscino seduta acrilico<br>Acrylic seat cushion<br>x cod. 527<br>W113/119 - D49 - H2<br>Kg 0,90 | <table border="1"> <tr><td>700/4</td></tr> <tr><td>700/12</td></tr> <tr><td>700/13</td></tr> <tr><td>700/14*</td></tr> </table> | 700/4                                | 700/12 | 700/13 | 700/14* | Tessuti Basic<br>Basic Fabrics |
| 700/4   |   |                                      |        |        |         |                                |
| 700/12  |   |                                      |        |        |         |                                |
| 700/13  |   |                                      |        |        |         |                                |
| 700/14*   |   |                                      |        |        |         |                                |

\* Cuscino visibile in foto—Cushion in the picture

### ALTRI PRODOTTI IN COLLEZIONE—OTHER COLLECTION'S PRODUCTS



DARWIN  
Cod. 526  
Tavolo basso  
Coffee table  
PAG. 250



DARWIN  
Cod. 528  
Tavolo alto abbattibile  
2 posti  
2 seats collapsible  
high table  
PAG. 164



DARWIN  
Cod. 529  
Tavolo abbattibile 2/4 posti  
2/4 seats collapsible table  
PAG. 164

## PLUS

• Cuscini in tessuto acrilico C/524 e C/527, sfoderabile, con sistema di fissaggio in velcro.  
C/524 and C/527 cushions in acrylic fabric, cover removable, with velcro fastening system.



Scansiona e scopri i progetti.  
Scan and discover the projects.



280  
Sedia  
Chair



Esclusive modellature che garantiscono il massimo comfort delle sedute in uso.  
Specific shaping to ensure maximum comfort of the seating in use.

281  
Poltroncina  
Armchair



La pressofusione in alluminio del sedile e dello schienale conferisce alla collezione l'esclusiva ergonomia.  
The aluminium die-casting of seat and backrest makes the collection exclusively ergonomic.

283  
Sgabello  
Barstool



## PRODOTTI—PRODUCTS

| Codice/Code<br>Tipologia/Typology | Disegno/Drawing | Info | TEST |
|-----------------------------------|-----------------|------|------|
|-----------------------------------|-----------------|------|------|

|  |  |  |                  |
|--|--|--|------------------|
| 280<br>Sedia<br>Chair<br>W52 - D52 - H78<br>Kg 4,8 |  |  | EN581-1/ EN581-2 |
|--|--|--|------------------|

|   |  |  |                  |
|---|--|--|------------------|
| 281<br>Poltroncina<br>Armchair<br>W52 - D58 - H78<br>Kg 5,2 |  |  | EN581-1/ EN581-2 |
|---|--|--|------------------|

|  |  |  |  |
|--|--|--|--|
| 283<br>Sgabello<br>Barstool<br>W51 - D53 - H90<br>Kg 5,1 |  |  |  |
|--|--|--|--|

### COLORI STRUTTURA—FRAME COLORS

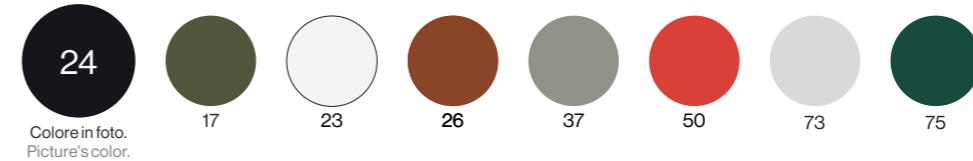

### CUSCINI—CUSHIONS

| Codice/Code<br>Tipologia/Typology  | Colori tessuto<br>Fabric colors | Categoria tessuto<br>Fabric category                  |
|--|---------------------------------|---|
| C/707<br>Cuscino universale poliestere<br>Polyester universal cushion<br>x cod. 280, 281<br>W44 - D38 - H2 Kg 0,23 |                                 | Tessuti Cuscini Contract<br>Contract Cushions Fabrics |

\* Cuscino visibile in foto—Cushion in the picture

### ALTRI PRODOTTI IN COLLEZIONE—OTHER COLLECTION'S PRODUCTS



GRACE  
Cod. 285+286  
Tavolo bordo quadro abbattibile 2/4 posti  
2/4 seats collapsible square border table  
PAG. 168



GRACE  
Cod. 285+547  
Tavolo bordo tondo abbattibile 2/4 posti  
2/4 seats collapsible round border table  
PAG. 168

### PLUS

- Tubo in lega di alluminio ad alta resistenza.—Pipe in high resistant aluminium alloy.
- Viteria in acciaio inox che diminuisce il rischio di corrosione, ruggine e deterioramento da agenti atmosferici.  
Stainless steel screws that reduce the risk of corrosion, rust and deterioration due to weather conditions.
- Cuscino universale C/707 in tessuto poliestere idrorepellente con sistema antiscivolo.  
Polyester universal cushion C/707 in water-repellent fabric with non-slip system.

# HEAVEN

Design by Jean-Marie Massaud



Scansiona e scopri i progetti.  
Scan and discover the projects.

485  
Sedia  
Chair

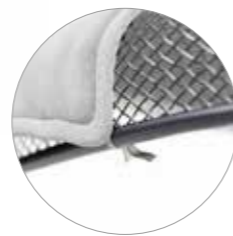

Fissaggio cuscino con lacci.  
Cushion fastening with laces.

486  
Poltroncina  
Armchair



La tecnologia a proiezione conferisce una migliore pulizia estetica della saldatura della rete alla struttura tubolare.  
The spot technology conveys a sharper welding of the mesh to the tubular frame.

## PRODOTTI—PRODUCTS



| Codice/Code<br>Tipologia/Typology | Disegno/Drawing | Info |
|-----------------------------------|-----------------|------|
|-----------------------------------|-----------------|------|

485

Sedia  
Chair  
W62 - D59 - H79  
Kg 7,3

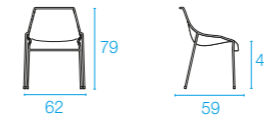

486

Poltroncina  
Armchair  
W69 - D61 - H79  
Kg 8,5

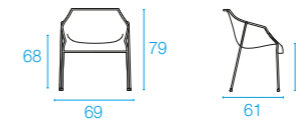

### COLORI STRUTTURA—FRAME COLORS

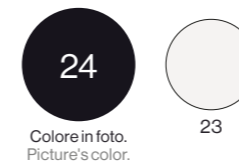

Colore in foto.  
Picture's color.

### CUSCINI—CUSHIONS

| Codice/Code<br>Tipologia/Typology  | Colori tessuto<br>Fabric colors | Categoria tessuto<br>Fabric category |
|--|---------------------------------|--------------------------------------|
| <b>C/485</b><br>Cuscino seduta e schienale polipropilene<br>Polypropylene seat and back cushion<br>x cod. 485<br>W97 - D37 - H4<br>Kg 0,55 | 900/71*<br>900/75<br>900/77     | Tessuti Standard<br>Standard Fabrics |
| <b>C/486</b><br>Cuscino seduta e schienale polipropilene<br>Polypropylene seat and back cushion<br>x cod. 486<br>W96 - D42 - H4<br>Kg 0,60 | 900/71*<br>900/75<br>900/77     | Tessuti Standard<br>Standard Fabrics |

\* Cuscino visibile in foto—Cushion in the picture

## PLUS

• Lamiera intrecciata zincata a caldo, esclusiva per la collezione Heaven.  
Hot-dip zincated woven wire mesh, specific for Heaven collection.

# HEAVEN

Design by Jean-Marie Massaud



Scansiona e scopri i progetti.  
Scan and discover the projects.

487  
Poltrona  
Lounge chair



## PRODOTTI—PRODUCTS

| Codice/Code<br>Tipologia/Typology | Disegno/Drawing | Info |
|-----------------------------------|-----------------|------|
|-----------------------------------|-----------------|------|

487

Poltrona  
Lounge chair  
W94 - D78 - H69  
Kg 11,3

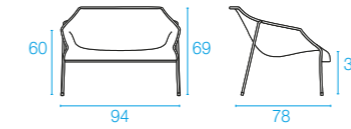

### COLORI STRUTTURA—FRAME COLORS

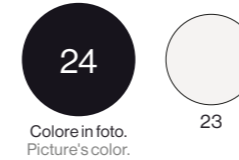

### CUSCINI—CUSHIONS

| Codice/Code<br>Tipologia/Typology   | Colori tessuto<br>Fabric colors | Categoria tessuto<br>Fabric category   |
|---|---------------------------------|--|
| <b>C/701</b><br>Cuscino decorativo—Decorative cushion<br>x cod. 487<br>W40 - D40 - H15 Kg 0,7 | <input type="checkbox"/>        | Vedi pg. 325<br>Look at pg. 325<br><br>Tessuti Basic (Vedi riepilogo pg. 325)<br>Tessuti Standard (Vedi riepilogo pg. 325)<br>Tessuti Premium (Vedi riepilogo pg. 325)<br>Basic Fabrics (Look at pg. 325)<br>Standard Fabrics (Look at pg. 325)<br>Premium Fabrics (Look at pg. 325) |
| <b>C/705</b><br>Cuscino decorativo—Decorative cushion<br>x cod. 487<br>W45 - D35 - H15 Kg 0,6 | <input type="checkbox"/>        |  |
| <b>C/706</b><br>Cuscino decorativo—Decorative cushion<br>x cod. 487<br>W60 - D40 - H20 Kg 0,8 | <input type="checkbox"/>        |  |

### ALTRI PRODOTTI IN COLLEZIONE—OTHER COLLECTION'S PRODUCTS

60



HEAVEN  
Cod. 494+494/V  
Tavolo tondo 4/6 posti  
4/6 seats round table  
PAG. 170



HEAVEN  
Cod. 496+494/V  
Tavolo basso  
Coffee table  
PAG. 252



HEAVEN  
Cod. 497  
Vaso alto  
Tall vase  
PAG. 310

61





Scansiona e scopri i progetti.  
Scan and discover the projects.



1310  
Poltroncina  
Armchair



Prodotti realizzati con robusti estrusi di alluminio (tubo 40x20 poltroncina, tubo 50x25 poltrona reclinabile e poggiatesta) che garantiscono una grande solidità in qualunque uso.

The aluminium extruded pipes (40x20 pipe for the armchair, 50x25 pipe for the reclining lounge chair and footrest) guarantee great solidity in any use.

1311  
Poltrona reclinabile  
Reclining lounge chair



Poltrona lounge con schienale alto reclinabile in 4 posizioni.  
Lounge armchair with high reclining backrest in 4 positions.

1313  
Poggiatesta  
Foot stool



## ALTRI PRODOTTI IN COLLEZIONE—OTHER COLLECTION'S PRODUCTS



HOLLY  
Cod. 195  
Lettino impilabile con ruote a scomparsa  
Stackable sunbed with hidden wheels  
PAG. 272



HOLLY  
Cod. 196  
Tavolo basso  
Coffee table  
PAG. 254

## PRODOTTI—PRODUCTS

| Codice/Code<br>Tipologia/Typology  | Disegno/Drawing | Info |
|--|-----------------|------|
| 1310<br>Poltroncina<br>Armchair<br>W57 - D60 - H86<br>Kg 5,6                         |                 |      |
| 1311<br>Poltrona reclinabile<br>Reclining lounge chair<br>W65 - D77 - H107<br>Kg 7,9 |                 |      |
| 1313<br>Poggiatesta<br>Foot stool<br>W65 - D52 - H44<br>Kg 6,4                       |                 |      |

## COLORI STRUTTURA/SEDUTA E SCHIENALE—FRAME/SEAT AND BACKREST COLORS



Le immagini dei colori sono a scopo illustrativo. Per vedere la trama degli EMU-Tex, consultare pg. 341.  
All colors images shown are for illustration purposes only. Look at pg. 341 to see the texture of the EMU-Tex.

## PLUS

- Collezione completa di elementi dining e relax, ottima per tutti gli usi all'esterno e particolarmente indicata in prossimità di mare e piscine.— Complete collection made up of dining and relaxing elements, excellent for all outdoor uses and particularly suitable for swimming pools and seaside areas.
- Combinazione di alluminio ed EMU-Tex per la struttura portante. Particolari in acciaio inossidabile.  
Combination of aluminium and EMU-Tex for the load-bearing frame. Details in stainless steel.
- Elevata impilabilità di poltroncina e poltrona lounge reclinabile.  
High stackability of armchair and reclining lounge chair.
- Poggiatesta utilizzabile anche come seduta.— Footrest can also be used as a seat.
- Studiata per permettere una facile sostituzione del telo da parte del cliente.  
Designed to allow the customer to easy replace the cloth.

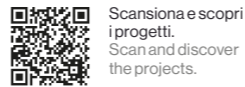

Scansiona e scopri i progetti.  
Scan and discover the projects.



615  
Sedia  
Chair



La pressofusione in alluminio del sedile conferisce alla collezione l'esclusiva ergonomia.  
The aluminium die-casting of the seat makes the collection exclusively ergonomic.

616  
Poltroncina  
Armchair



Cuscino sedile con antiscivolo e cuscino schienale con sistema di fissaggio in velcro.  
Non-slip seat cushion and backrest cushion with velcro fastening system.

617  
Poltrona  
Lounge chair

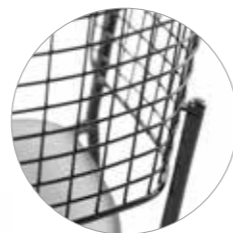

L'assemblaggio dei tondini che costituiscono la griglia dello schienale è un processo interamente manuale che conferisce un design esclusivo al prodotto. Il fissaggio alla struttura è realizzato senza viti a vista.  
The assembling of the backrest grid made of bars is a crafted process that gives an exclusive design to the product. The fixing of the backrest to the frame is made without visible screws.

## PRODOTTI—PRODUCTS

| Codice/Code<br>Tipologia/Typology                            | Disegno/Drawing | Info | TEST             |
|--|-----------------|------|------------------|
| 615<br>Sedia<br>Chair<br>W47 - D54 - H79<br>Kg 4,8           |                 |      | EN581-1/ EN581-2 |
| 616<br>Poltroncina<br>Armchair<br>W62 - D57 - H79<br>Kg 7,0  |                 |      | EN581-1/ EN581-2 |
| 617<br>Poltrona<br>Lounge chair<br>W76 - D72 - H73<br>Kg 8,3 |                 |      | EN581-1/ EN581-2 |

### COLORI STRUTTURA/SEDUTA/SCHIENALE—FRAME/SEAT/BACK COLORS

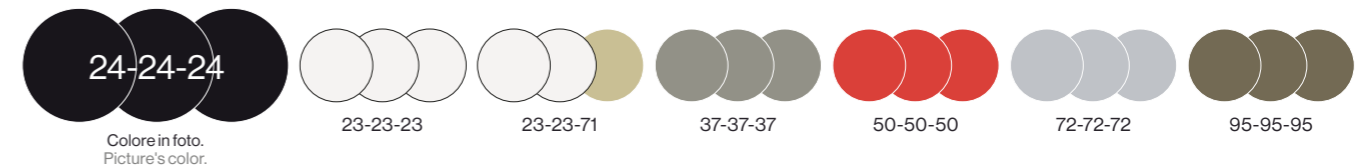

## CUSCINI—CUSHIONS

| Codice/Code<br>Tipologia/Typology   | Colori tessuto<br>Fabric colors | Categoria tessuto<br>Fabric category |
|---|---------------------------------|--------------------------------------|
| C/615<br>Cuscino seduta polipropilene<br>Polypropylene seat cushion<br>x cod. 615, 616<br>W33/38 - D44 - H3<br>Kg 0,2                                   | 900/71*<br>900/75<br>900/77     | Tessuti Standard<br>Standard Fabrics |
| C/616<br>Cuscino seduta e schienale polipropilene<br>Polypropylene seat and back cushion<br>x cod. 616<br>W33/38 - D44 - H3 W41/47 - D30 - H3<br>Kg 0,4 | 900/71*<br>900/75<br>900/77     |                                      |
| C/617<br>Cuscino seduta e schienale polipropilene<br>Polypropylene seat and back cushion<br>x cod. 617<br>W44/49 - D50 - H3 W50/57 - D30 - H3<br>Kg 0,5 | 900/71*<br>900/75<br>900/77     |                                      |

## PLUS

• Schienale in griglia di tondini zincati a caldo saldati a proiezione.  
Backrest grid made of spot-welded hot-dip zincated bars.



Scansiona e scopri i progetti.  
Scan and discover the projects.



615  
Sedia  
Chair



616  
Poltroncina  
Armchair



Sedile in teak FSC® per un piacevole effetto tattile e visivo.  
Teak FSC® seat for a pleasant touch, look and feel.

617  
Poltrona  
Lounge chair



## COMBINAZIONI CONSIGLIATE—SUGGESTED MATCHINGS



SHINE  
Cod. 254+257  
Tavolo 2/4 posti con piano in teak  
2/4 seats table with teak top  
PAG. 184



SHINE  
Cod. 252  
Tavolo basso  
Coffee table  
PAG. 260



ROUND  
Cod. 473  
Tavolo quadrato 2/4 posti  
2/4 seats square table  
PAG. 180

## PRODOTTI—PRODUCTS

| Codice/Code<br>Tipologia/Typology                            | Disegno/Drawing | Info | TEST             |
|--|-----------------|------|------------------|
| 615<br>Sedia<br>Chair<br>W47 - D54 - H79<br>Kg 5,0           |                 |      | EN581-1/ EN581-2 |
| 616<br>Poltroncina<br>Armchair<br>W62 - D57 - H79<br>Kg 7,4  |                 |      | EN581-1/ EN581-2 |
| 617<br>Poltrona<br>Lounge chair<br>W76 - D72 - H73<br>Kg 8,6 |                 |      | EN581-1/ EN581-2 |

## COLORI STRUTTURA/SEDUTA/SCHIENALE—FRAME/SEAT/BACK COLORS

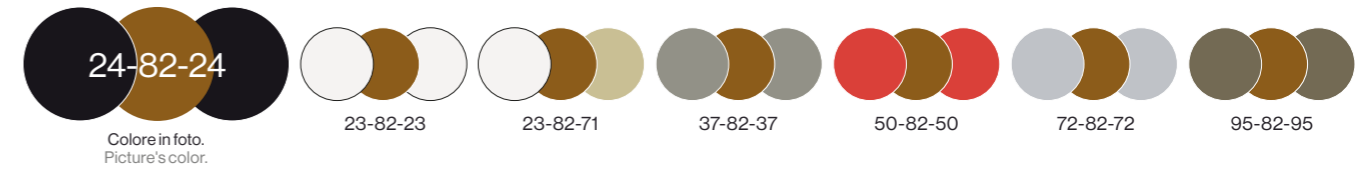

## CUSCINI—CUSHIONS

| Codice/Code<br>Tipologia/Typology   | Colori tessuto<br>Fabric colors | Categoria tessuto<br>Fabric category |
|---|---------------------------------|--------------------------------------|
| C/615<br>Cuscino seduta polipropilene<br>Polypropylene seat cushion<br>x cod. 615, 616<br>W33/38 - D44 - H3<br>Kg 0,2                                   | 900/71<br>900/75<br>900/77      | Tessuti Standard<br>Standard Fabrics |
| C/616<br>Cuscino seduta e schienale polipropilene<br>Polypropylene seat and back cushion<br>x cod. 616<br>W33/38 - D44 - H3 W41/47 - D30 - H3<br>Kg 0,4 | 900/71<br>900/75<br>900/77      |                                      |
| C/617<br>Cuscino seduta e schienale polipropilene<br>Polypropylene seat and back cushion<br>x cod. 617<br>W44/49 - D50 - H3 W50/57 - D30 - H3<br>Kg 0,5 | 900/71<br>900/75<br>900/77      |                                      |

## PLUS

- Al caratteristico disegno del prodotto si aggiunge la nota naturale e sofisticata del teak che apre ad un utilizzo più trasversale anche in ambienti indoor.—The natural and sophisticated teak nuance enhances the characteristic design of the product and make the collection even suitable to indoor contexts.
- Il comfort delle sedute è garantito anche senza l'utilizzo del cuscino.  
The seating comfort is allowed even without cushion.



Scansiona e scopri i progetti.  
Scan and discover the projects.



410  
Sedia  
Chair



Sedile e schienale in lamiera imbutita di alluminio che conferiscono alle sedute l'esclusiva ergonomia. Deep-drawn aluminium seat and backrest make the seating exclusively ergonomic.

411  
Poltroncina  
Armchair



412  
Sgabello  
Barstool



Protezione poggia piedi in acciaio inossidabile AISI 316 che diminuisce il rischio di corrosione e deterioramento da agenti atmosferici. AISI 316 stainless steel footrest component that reduce the risk of corrosion and deterioration due to weather conditions.

## PRODOTTI—PRODUCTS

| Codice/Code<br>Tipologia/Typology                           | Disegno/Drawing | Info | TEST             |
|---|-----------------|------|------------------|
| 410<br>Sedia<br>Chair<br>W49 - D52 - H78<br>Kg 5,5          |                 |      | EN581-1/ EN581-2 |
| 411<br>Poltroncina<br>Armchair<br>W57 - D52 - H78<br>Kg 5,6 |                 |      | EN581-1/ EN581-2 |
| 412<br>Sgabello<br>Barstool<br>W47 - D50 - H99<br>Kg 7,7    |                 |      |                  |

### COLORI STRUTTURA—FRAME COLORS

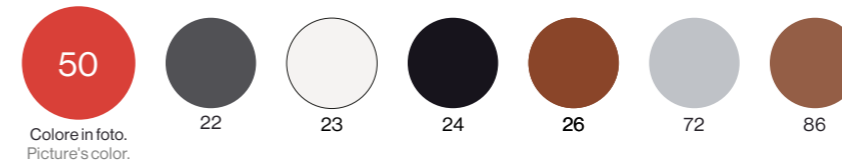

### CUSCINI—CUSHIONS

| Codice/Code<br>Tipologia/Typology  | Colori tessuto<br>Fabric colors | Categoria tessuto<br>Fabric category                  |
|--|---------------------------------|---|
| C/703<br>Cuscino EMU acrilico quadrato<br>Acrylic EMU square cushion<br>x cod. 410, 411, 412<br>W38 - D38 - H2<br>Kg 0,13  |                                 | Tessuti Basic<br>Basic Fabrics                        |
| C/709<br>Cuscino universale poliestere<br>Polyester universal cushion<br>x cod. 410, 411, 412<br>W37 - D37 - H2<br>Kg 0,17 |                                 | Tessuti Cuscini Contract<br>Contract Cushions Fabrics |
| C/716<br>Cuscino universale poliestere<br>Polyester universal cushion<br>x cod. 410, 411, 412<br>W40 - D38 - H2<br>Kg 0,19 |                                 | Tessuti Cuscini Contract<br>Contract Cushions Fabrics |

\* Cuscino visibile in foto—Cushion in the picture

### COMBINAZIONI CONSIGLIATE—SUGGESTED MATCHINGS



DARWIN  
Cod. 529  
Tavolo abbattibile 2/4 posti  
2/4 seats collapsible table  
PAG. 164



TABLE SYSTEM  
Cod. 1168  
Tavolo bordo squadrato  
2/4 posti  
2/4 seats square border  
table  
PAG. 196



NOVA  
Cod. 893  
Tavolo alto rettangolare  
4 posti  
4 seats counter  
rectangular table  
PAG. 142

## PLUS

- Struttura in tubo acciaio ad alta resistenza.—High-strength steel pipe frame.
- Cuscino in tessuto acrilico C/703, sfoderabile, con fissaggio tramite laccetti. C/703 cushion in acrylic fabric, cover removable, with laces fastening.
- Cuscino C/709 e C/716 con fissaggio antiscivolo.—Non-slip cushions C/709 and C/716.



Scansiona e scopri i progetti.  
Scan and discover the projects.



637  
Sedia  
Chair



Sedile in lamiera stampata saldato alla struttura e schienale fissato con rivetti in acciaio inox. Tali rivetti riducono il rischio di corrosione, ruggine e deterioramento da agenti atmosferici.  
Moulded seat welded to the frame and backrest fixed with stainless steel rivets. These rivets reduce risk of corrosion, rust and deterioration due to weather conditions.

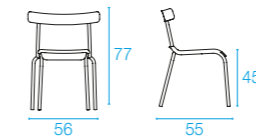

637  
Sedia  
Chair  
W56 - D55 - H77  
Kg 5,1

638  
Poltroncina  
Armchair



Fissaggio cuscino con clip a incastro.  
Cushion fastening with snap-fit clip to the seat grooves.

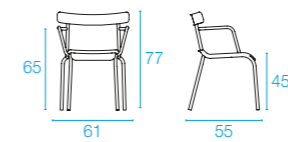

638  
Poltroncina  
Armchair  
W61 - D55 - H77  
Kg 5,9

## COLORI STRUTTURA—FRAME COLORS

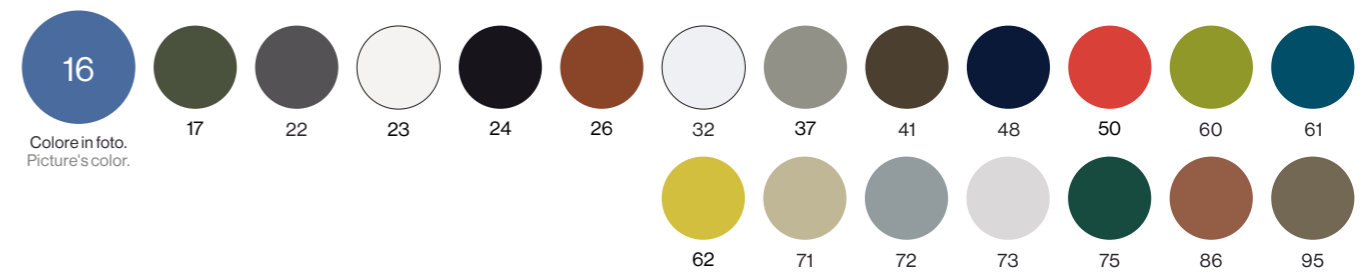

## CUSCINI—CUSHIONS

Codice/Code  
Tipologia/Typology

Colori tessuto  
Fabric colors

Categoria tessuto  
Fabric category

C/637  
Cuscino seduta poliestere  
Polyester seat cushion  
x cod. 637, 638  
W39 - D34 - H3  
Kg 0,18



|         |
|---------|
| 500/28  |
| 500/29  |
| 500/30* |
| 500/31  |
| 500/51  |

Tessuti Cuscini Contract  
Contract Cushions Fabrics

\* Cuscino visibile in foto—Cushion in the picture

## COMBINAZIONI CONSIGLIATE—SUGGESTED MATCHINGS

70



DARWIN  
Cod. 848  
Tavolo abbattibile 2 posti  
2 seats collapsible table  
PAG. 166



TABLE SYSTEM  
Cod. 1171  
Tavolo bordo quadrato 5/6 posti  
5/6 seats square border table  
PAG. 198



STAR  
Cod. 307  
Tavolo rettangolare 6 posti  
6 seats rectangular table  
PAG. 146

## PLUS

- Sedile e schienale in lamiera zincata a caldo, particolarmente resistente agli agenti atmosferici, sagomati per migliorare il comfort della seduta.—Seat and backrest in hot-zincated sheet shaped to improve the comfort of the seat. Extreme resistance to weather conditions.
- Fessure di lamiera conformi a direttive di sicurezza internazionali.  
Sheet grooves in compliance with international safety regulations.

71

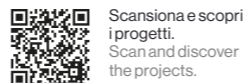

639  
Sedia  
Chair



Cuscini in tessuto acrilico C/640 e C/641 con fissaggio tramite elastico.  
C/640 and C/641 cushions in acrylic fabric with rubber band fastening.



Cuscino in tessuto poliestere C/639 con fissaggio tramite clip ad incastro.  
C/639 cushion in polyester fabric with snap-fit clip fastening to the seat grooves.

640  
Poltroncina  
Armchair



Fissaggio dello schienale alla struttura tramite rivetti in acciaio inox. Tali rivetti riducono il rischio di corrosione, ruggine e deterioramento da agenti atmosferici.  
Backrest fixing to the frame with stainless steel rivets. These rivets reduce risk of corrosion, rust and deterioration due to weather conditions.

## PRODOTTI—PRODUCTS

| Codice/Code<br>Tipologia/Typology | Disegno/Drawing | Info | TEST |
|-----------------------------------|-----------------|------|------|
|-----------------------------------|-----------------|------|------|

**639**  
Sedia  
Chair  
W53 - D56 - H76  
Kg 6,3

EN581-1/ EN581-2

**640**  
Poltroncina  
Armchair  
W58,5 - D56 - H76  
Kg 7,4

EN581-1/ EN581-2

### COLORI STRUTTURA—FRAME COLORS

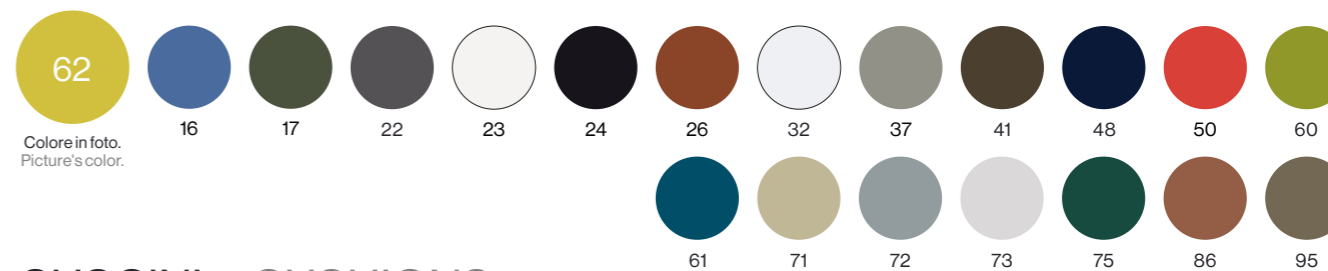

### CUSCINI—CUSHIONS

| Codice/Code<br>Tipologia/Typology   | Colori tessuto<br>Fabric colors                 | Categoria tessuto<br>Fabric category                  |
|---|---|---|
| <b>C/639</b><br>Cuscino seduta poliestere<br>Polyester seat cushion<br>x cod. 639, 640<br>W43 - D43 - H2 Kg 0,23          | 500/28<br>500/29<br>500/30<br>500/31<br>500/51  | Tessuti Cuscini Contract<br>Contract Cushions Fabrics |
| <b>C/640</b><br>Cuscino seduta acrilico<br>Acrylic seat cushion<br>x cod. 639, 640<br>W44 - D44 - H3 Kg 0,28              | 700/4<br>700/10*<br>700/12<br>700/13<br>700/14  | Tessuti Basic<br>Basic Fabrics                        |
| <b>C/641</b><br>Cuscino schienale acrilico<br>Acrylic back cushion<br>x cod. 639, 640<br>W53 - D26 - H3 Kg 0,21           | 700/4<br>700/10*<br>700/12<br>700/13<br>700/14  | Tessuti Basic<br>Basic Fabrics                        |
| <b>C/708</b><br>Cuscino universale poliestere<br>Polyester universal cushion<br>x cod. 639, 640<br>W43 - D43 - H2 Kg 0,23 | 500/28<br>500/29<br>500/30*<br>500/31<br>500/51 | Tessuti Cuscini Contract<br>Contract Cushions Fabrics |

\* Cuscino visibile in foto—Cushion in the picture

### COMBINAZIONI CONSIGLIATE—SUGGESTED MATCHINGS



TABLE SYSTEM  
Cod. 1156  
Tavolo bordo tondo  
5/6 posti  
5/6 seats round  
border table  
PAG. 192



ROUND  
Cod. 470  
Tavolo tondo 4 posti  
4 seats round table  
PAG. 182



NOVA  
Cod. 859  
Tavolo quadrato impilabile  
4 posti  
4 seats stackable square  
table  
PAG. 140

## PLUS

• Fessure di lamiera conformi a direttive di sicurezza internazionali.  
Sheet grooves in compliance with international safety regulations.  
• Sedile e schienale in lamiera stampata prezinccata a caldo, particolarmente resistente agli agenti atmosferici, sagomati per migliorare il comfort della seduta.—Moulded seat and backrest in pre hot-zincated sheet shaped to improve the comfort of the seat. Extreme resistance to weather conditions.



Scansiona e scopri i progetti.  
Scan and discover the projects.



**626**  
Poltroncina  
Armchair

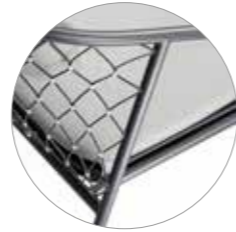

Schienale realizzato con una rete in fibra di polipropilene e ganci in acciaio inossidabile che garantisce il comfort della collezione. La rete è fissata alla struttura perimetrale tramite un sistema esclusivo sviluppato da EMU e brevettato. Backrest made of a polypropylene fiber net and stainless steel hooks that guarantees maximum comfort to the seating collection. The net is fixed to the perimeter frame with an exclusive system developed by EMU and patented.

**627**  
Poltrona schienale alto  
Lounge chair tall back



Cuscino schienale con sistema di fissaggio tramite elastici e gancetti. Cuscino seduta con sistema di fissaggio in velcro. Backrest cushion with fastening system by rubber bands and hooks. Seat cushion with velcro fastening system.

**628**  
Poltrona schienale basso  
Lounge chair short back



## PRODOTTI—PRODUCTS

| Codice/Code<br>Tipologia/Typology  | Disegno/Drawing | Info | TEST             |
|--|-----------------|------|------------------|
| <b>626</b><br>Poltroncina<br>Armchair<br>W63 - D60 - H81<br>Kg 4,1                             |                 |      | EN581-1/ EN581-2 |
| <b>627</b><br>Poltrona schienale alto<br>Lounge chair tall back<br>W88 - D84 - H125<br>Kg 8,8  |                 |      | EN581-1/ EN581-2 |
| <b>628</b><br>Poltrona schienale basso<br>Lounge chair short back<br>W83 - D76 - H83<br>Kg 7,4 |                 |      |                  |

### COLORI STRUTTURA/SCHIENALE—FRAME/BACK COLORS

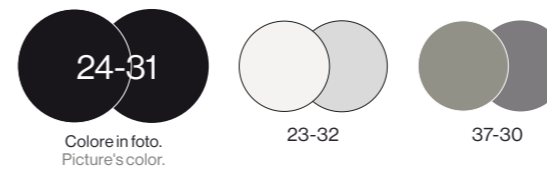

### CUSCINI—CUSHIONS

| Codice/Code<br>Tipologia/Typology  | Colori tessuto<br>Fabric colors | Categoria tessuto<br>Fabric category |
|--|---------------------------------|--------------------------------------|
| <b>C/626</b><br>Cuscino seduta polipropilene<br>Polypropylene seat cushion<br>x cod. 626<br>W40/45 - D43 - H4<br>Kg 0,34   | <br>900/71*<br>900/75<br>900/77 | Tessuti Standard<br>Standard Fabrics |
| <b>S/626</b><br>Cuscino schienale polipropilene<br>Polypropylene back cushion<br>x cod. 626<br>W51 - D19 - H3<br>Kg 0,11   | <br>900/71*<br>900/75<br>900/77 |                                      |
| <b>C/627</b><br>Cuscino seduta e schienale polipropilene<br>Polypropylene seat and back cushion<br>x cod. 627, 628<br>W40/57 - D58 - H10 W40/63 - D50 - H10<br>Kg 1,80 | <br>900/71*<br>900/75<br>900/77 |                                      |

\* Cuscino visibile in foto—Cushion in the picture

### COMBINAZIONI CONSIGLIATE—SUGGESTED MATCHINGS



YARD  
Cod. 509  
Tavolo basso  
Coffee table  
PAG. 264



YARD  
Cod. 507  
Tavolo basso  
Coffee table  
PAG. 264



URBAN  
Cod. 096  
Tavolo impilabile 2/4 posti  
2/4 seats stackable table  
PAG. 154

## PLUS

• Leggerezza garantita da una robusta struttura in tubolare di alluminio a cui è fissato un sedile in lamiera di alluminio piegato e sagomato.—Lightness guaranteed by a sturdy aluminium tubular frame to which a folded and shaped aluminium sheet seat is attached.



Scansiona e scopri i progetti.  
Scan and discover the projects.



909  
Sedia  
Chair

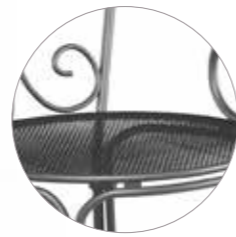

Sedile in lamiera stirata zincata a caldo che facilita lo scolo dell'acqua.  
Seat made of hot-dip zincated expanded sheet that facilitates the drainage of water.

910  
Poltroncina  
Armchair



924  
Sedia pieghevole  
Folding chair



Sedile in lamiera di acciaio zincata a caldo con fori decorativi che facilitano lo scolo dell'acqua.  
Seat made of hot-dip zincated steel sheet with decorative holes that facilitate the drainage of water.

## PRODOTTI—PRODUCTS

| Codice/Code<br>Tipologia/Typology                                     | Disegno/Drawing | Info |
|---|-----------------|------|
| 909<br>Sedia<br>Chair<br>W45 - D52 - H85<br>Kg 5,2                    |                 |      |
| 910<br>Poltroncina<br>Armchair<br>W50 - D54 - H85<br>Kg 6,8           |                 |      |
| 924<br>Sedia pieghevole<br>Folding chair<br>W42 - D57 - H88<br>Kg 5,6 |                 |      |

### COLORI STRUTTURA—FRAME COLORS

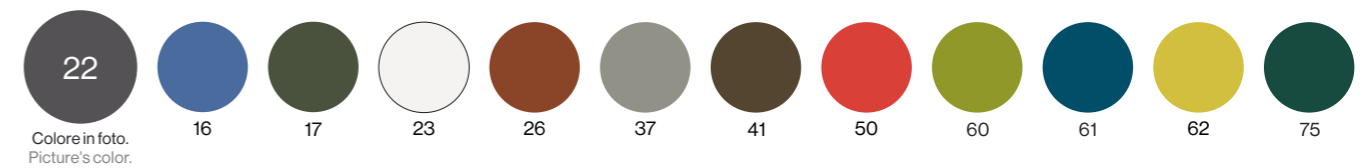

## CUSCINI—CUSHIONS

| Codice/Code<br>Tipologia/Typology   | Colori tessuto<br>Fabric colors                | Categoria tessuto<br>Fabric category   |
|---|--|--|
| C/711<br>Cuscino magnetico EMU-TEX tondo<br>EMU-TEX round magnetic cushion<br>x cod. 909, 910, 924<br>ø38 - H1,5<br>Kg 0,17 | 300/10<br>300/11<br>300/12                     | Cuscini Magnetici<br>Magnetic Cushions |
| C/704<br>Cuscino EMU acrilico tondo<br>Acrylic EMU round cushion<br>x cod. 909, 910, 924<br>ø38,5 - H2<br>Kg 0,11           | 700/4<br>700/10<br>700/12*<br>700/13<br>700/14 | Tessuti Basic<br>Basic Fabrics         |

\* Cuscino visibile in foto—Cushion in the picture

### ALTRI PRODOTTI IN COLLEZIONE—OTHER COLLECTION'S PRODUCTS



PIGALLE  
Cod. 906  
Tavolo tondo 2/4 posti  
2/4 seats round table  
PAG. 144



PIGALLE  
Cod. 907  
Tavolo pieghevole  
2/4 posti  
2/4 seats folding table  
PAG. 144



PIGALLE  
Cod. 903  
Tavolo pieghevole 4/6 posti  
4/6 seats folding table  
PAG. 145

## PLUS

• Cuscino magnetico C/711 in EMU-TEX facile da rimuovere. Cuscino C/704: cuscino sfoderabile in tessuto acrilico.— C/711 magnetic cushion easy to remove. C/704 cover removable cushion in acrylic fabric.  
• Cod. 924: ottima per il rimessaggio invernale, piegata occupa pochissimo spazio.  
Cod. 924: perfect for winter storage, it can be folded and takes up very little space.



# RE-TROUVÉ

Design by Patricia Urquiola

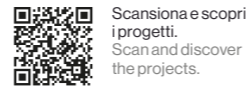

Scansiona e scopri i progetti.  
Scan and discover the projects.



565  
Sedia  
Chair



Lo stile romantico ed iconico della collezione Re-Trouvé evoca forme tipiche della lavorazione manuale.  
The romantic and iconic style of the Re-Trouvé collection reminds crafted shapes.

566  
Poltroncina  
Armchair



Fissaggio cuscino con lacci.  
Fastening of the cushion with laces.

575  
Pouf



La struttura è realizzata in tondini di acciaio zincato piegati con macchine a controllo numerico, per una maggiore precisione ed un migliore controllo del processo produttivo.  
The frame is manufactured in hot-dip zincated steel bar bent with numerical control machines for a more precise and accurate manufacturing process.

## PRODOTTI—PRODUCTS

| Codice/Code<br>Tipologia/Typology                               | Disegno/Drawing | Info |
|---|-----------------|------|
| 565<br>Sedia<br>Chair<br>W66 - D60 - H78<br>Kg 7,3              |                 |      |
| 566<br>Poltroncina<br>Armchair<br>W76 - D61 - H105<br>Kg 8,8    |                 |      |
| 575<br>Sedia pieghevole<br>Folding chair<br>ø45 - H45<br>Kg 5,0 |                 |      |

### COLORI STRUTTURA—FRAME COLOR

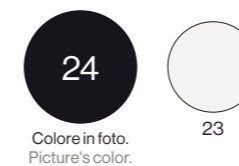

### CUSCINI—CUSHIONS

| Codice/Code<br>Tipologia/Typology   | Colori tessuto<br>Fabric colors | Categoria tessuto<br>Fabric category |
|---|---------------------------------|--------------------------------------|
| C/566<br>Cuscino seduta e schienale polipropilene<br>Polypropylene seat and back cushion<br>x cod. 565, 566<br>ø47 - H6 W60/73 - D25 - H4<br>Kg 0,8 | 900/71<br>900/75*               | Tessuti Standard<br>Standard Fabrics |
| C/575<br>Cuscino seduta polipropilene<br>Polypropylene seat cushion<br>x cod. 565, 566, 575<br>ø47 - H6<br>Kg 0,4                                   | 900/71<br>900/75*               | Tessuti Standard<br>Standard Fabrics |

\* Cuscino visibile in foto—Cushion in the picture

### ALTRI PRODOTTI IN COLLEZIONE—OTHER COLLECTION'S PRODUCTS



RE-TROUVÉ  
Cod. 569  
Tavolo tondo 5 posti  
5 seats round table  
PAG. 178



RE-TROUVÉ  
Cod. 570  
Tavolo tondo 6 posti  
6 seats round table  
PAG. 178



RE-TROUVÉ  
Cod. 577+580  
Vaso alto  
Tall vase  
PAG. 318

## PLUS

- Sedile in lamiera stirata prezinata a caldo saldato al tondino di struttura. Tale unico pezzo viene successivamente cataforizzato così da aumentare la resistenza all'ossidazione anche nei punti più critici.  
The seat in pre hot-dip zincated expanded sheet is welded to the bar frame. This single piece is then cataphorised to increase the resistance to oxidation even on the most critical points.
- Sottopiedi in nylon trasparente per maggiore stabilità su suolo irregolare; elemento comune a sedute, tavoli e vasi.  
Transparent nylon feet for a better stability on irregular floor; element for seats, tables and vases.
- Cuscini sfoderabili e lavabili.—Cover removable and washable cushions.

# RIO R50

Design by Cristell—Gargano



Scansiona e scopri i progetti.  
Scan and discover the projects.



790  
Sedia  
Chair



791  
Poltroncina  
Armchair



Rete in tondino zincato a caldo per una maggiore resistenza agli agenti atmosferici. I tondini sono saldati con tecnologia di saldatura a proiezione per una maggiore precisione e resistenza strutturale.  
Hot-dip zincated bar mesh for a greater weathering resistance. The bars are welded with spot technology for a greater precision and structural strength.

793  
Sgabello  
Barstool



Sagomatura ergonomica conferita da uno specifico stampo di imbutitura.  
Ergonomic shape due to a specific mould.

## PRODOTTI—PRODUCTS

| Codice/Code<br>Tipologia/Typology                               | Disegno/Drawing | Info | TEST            |
|---|-----------------|------|-----------------|
| 790<br>Sedia<br>Chair<br>W53,5 - D61,5 - H83,5<br>Kg 5,6        |                 |      | EN581-1/EN581-2 |
| 791<br>Poltroncina<br>Armchair<br>W53,5 - D59 - H83,5<br>Kg 6,2 |                 |      | EN581-1/EN581-2 |
| 793<br>Sgabello<br>Barstool<br>W49 - D55 - H96<br>Kg 7,3        |                 |      | EN581-1/EN581-2 |

### COLORI STRUTTURA—FRAME COLORS

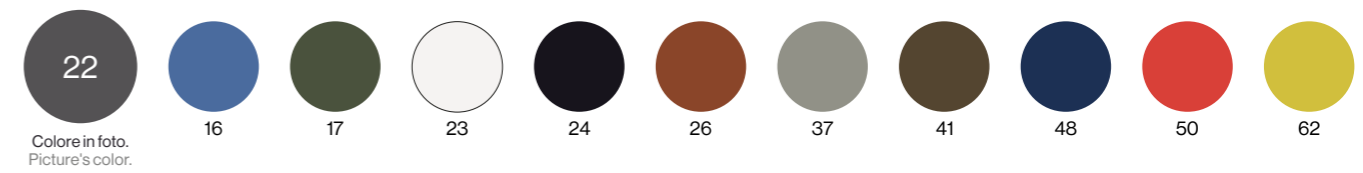

### CUSCINI—CUSHIONS

| Codice/Code<br>Tipologia/Typology   | Colori tessuto<br>Fabric colors                          | Categoria tessuto<br>Fabric category   |
|---|--|--|
| C/710<br>Cuscino magnetico EMU-Tex quadrato<br>EMU-Tex square magnetic cushion<br>x cod. 790, 791<br>W39 - D37 - H1,5 Kg 0,23     | 300/10<br>300/11<br>300/12                               | Cuscini Magnetici<br>Magnetic Cushions |
| C/712<br>Cuscino magnetico EMU-Tex rettangolare<br>EMU-Tex rectangular magnetic cushion<br>x cod. 793<br>W40 - D28 - H1,5 Kg 0,18 | 300/10<br>300/11<br>300/12<br>300/13<br>300/14<br>300/15 | Cuscini Magnetici<br>Magnetic Cushions |
| C/716<br>Cuscino universale poliesteri<br>Polyester universal cushion<br>x cod. 790, 791<br>W40 - D38 - H2 Kg 0,19                | 500/28<br>500/29<br>500/30<br>500/31<br>500/51           | Cuscini Contract<br>Cushions Contract  |

## PLUS

- Tubo in acciaio Asform ad alta resistenza meccanica.—Asform steel pipe with high static load resistance.
- Cuscini magnetici universali a calamita.—Universal magnetic cushions.

# RIO R50

Design by Cristell—Gargano



Scansiona e scopri i progetti.  
Scan and discover the projects.

792  
Poltrona  
Lounge chair



795  
Poltrona dondolo  
Rocking lounge chair



Poltrona a dondolo con protezione gamba a slitta in PVC.  
The rocking chair has a PVC skid leg protection.

## ALTRI PRODOTTI IN COLLEZIONE—OTHER COLLECTION'S PRODUCTS



RIO R50  
Cod. 797  
Tavolo basso  
Coffee table  
PAG. 256

## PRODOTTI—PRODUCTS



| Codice/Code<br>Tipologia/Typology | Disegno/Drawing | Info | TEST |
|-----------------------------------|-----------------|------|------|
|-----------------------------------|-----------------|------|------|

|   |  |  |                 |
|---|--|--|-----------------|
| <b>792</b><br>Poltrona<br>Lounge chair<br>W69 - D70 - H76<br>Kg 7,5 |  |  | EN581-1/EN581-2 |
|---|--|--|-----------------|

|   |  |  |  |
|---|--|--|--|
| <b>795</b><br>Poltrona dondolo<br>Rocking lounge chair<br>W67 - D72 - H77<br>Kg 8,0 |  |  |  |
|---|--|--|--|

### COLORI STRUTTURA—FRAME COLORS

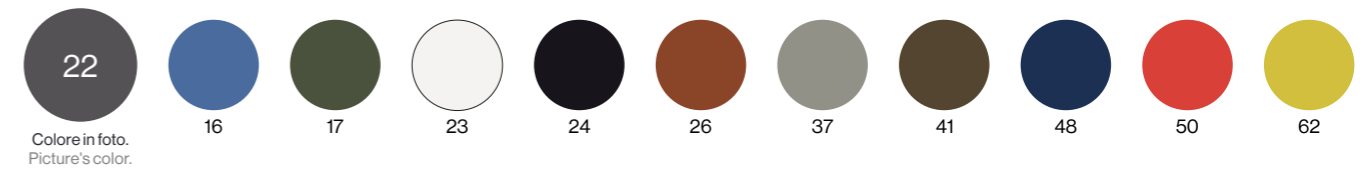

## CUSCINI—CUSHIONS

| Codice/Code<br>Tipologia/Typology | Colori tessuto<br>Fabric colors | Categoria tessuto<br>Fabric category |
|-----------------------------------|---------------------------------|--------------------------------------|
|-----------------------------------|---------------------------------|--------------------------------------|

|   |  |                            |  |
|---|--|----------------------------|--|
| <b>C/713</b><br>Cuscino magnetico EMU-Tex poltrona<br>EMU-Tex lounge chair magnetic cushion<br>x cod. 792, 795<br>W53 - D44 - H1,5 Kg 0,3 |  | 300/10<br>300/11<br>300/12 | Cuscini Magnetici<br>Magnetic Cushions |
|---|--|----------------------------|--|



Scansiona e scopri i progetti.  
Scan and discover the projects.



434  
Sedia  
Chair



Piatto in acciaio con profilo a mezza mandorla utilizzato esclusivamente per la collezione Riviera.  
Half almond steel profile exclusively used for Riviera collection.

435  
Poltroncina  
Armchair



Cuscino sfoderabile C/434 in tessuto con fissaggio in velcro.  
C/434 cover removable fabric cushion with velcro fastening system.

436  
Sgabello  
Barstool



## PRODOTTI—PRODUCTS

| Codice/Code<br>Tipologia/Typology                             | Disegno/Drawing | Info | TEST            |
|---|-----------------|------|-----------------|
| 434<br>Sedia<br>Chair<br>W50 - D56,5 - H78<br>Kg 6,6          |                 |      | EN581-1/EN581-2 |
| 435<br>Poltroncina<br>Armchair<br>W52 - D56,5 - H78<br>Kg 7,8 |                 |      | EN581-1/EN581-2 |
| 436<br>Sgabello<br>Barstool<br>W55 - D52,5 - H96<br>Kg 6,3    |                 |      |                 |

### COLORI STRUTTURA—FRAME COLORS

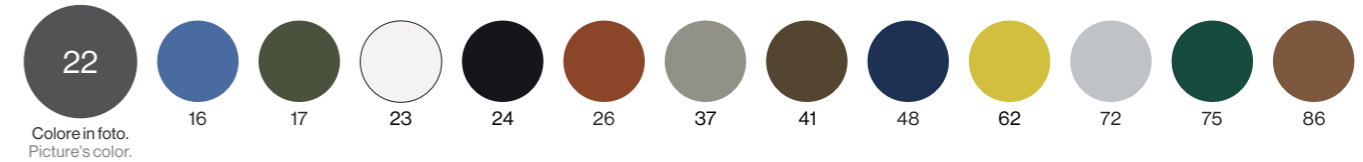

### CUSCINI—CUSHIONS

| Codice/Code<br>Tipologia/Typology  | Colori tessuto<br>Fabric colors | Categoria tessuto<br>Fabric category |
|--|---------------------------------|--------------------------------------|
| C/434<br>Cuscino seduta<br>Seat cushion<br>x cod. 434, 435<br>W40 - D38 - H2 Kg 0,2                                |                                 | Tessuti Standard<br>Standar Fabrics  |
| C/435<br>Cuscino seduta poliestere<br>Polyester seat cushion<br>x cod. 434, 435<br>W40 - D38 - H2 Kg 0,19          |                                 | Cuscini Contract<br>Cuscini Contract |
| C/716<br>Cuscino universale poliestere<br>Polyester universal cushion<br>x cod. 434, 435<br>W40 - D38 - H2 Kg 0,19 |                                 | Cuscini Contract<br>Cuscini Contract |

\* Cuscino visibile in foto—Cushion in the picture

### PLUS

- Saldobrasature ad ottone che conferiscono alle saldature un aspetto estetico molto pulito.  
Brass brazing that makes welding points even and aesthetic refined.
- Fissaggio cuscino C/435 con clip.—C/435 cushion with clip fastening.



Scansiona e scopri i progetti.  
Scan and discover the projects.

437  
Poltrona  
Lounge chair



## PRODOTTI—PRODUCTS

| Codice/Code<br>Tipologia/Typology | Disegno/Drawing | Info | TEST |
|-----------------------------------|-----------------|------|------|
|-----------------------------------|-----------------|------|------|

437  
Poltrona  
Lounge chair  
W66,5 - D72 - H69  
Kg9,2

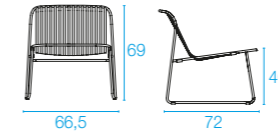

EN581-1/ EN581-2

### COLORI STRUTTURA—FRAME COLORS

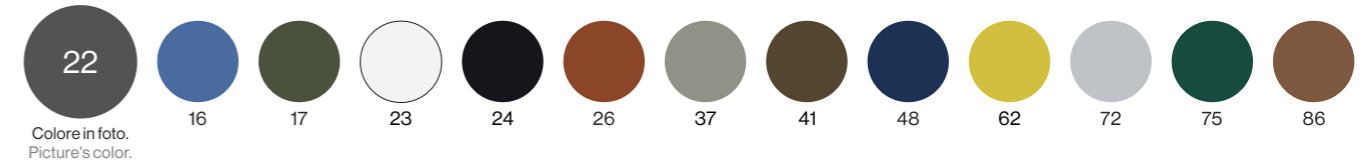

### CUSCINI—CUSHIONS

| Codice/Code<br>Tipologia/Typology   | Colori tessuto<br>Fabric colors   | Categoria tessuto<br>Fabric category |
|---|---|--------------------------------------|
| C/437<br>Cuscino seduta<br>Seat cushion<br>x cod. 437<br>W55 - D47 - H2 Kg0,4 | <ul style="list-style-type: none"> <li>900/02</li> <li>900/06</li> <li>900/07</li> <li>900/71*</li> <li>900/75</li> <li>900/77</li> <li>900/79</li> </ul> | Tessuti Standard<br>Standar Fabrics  |

\* Cuscino visibile in foto—Cushion in the picture

### COMBINAZIONI CONSIGLIATE—SUGGESTED MATCHINGS

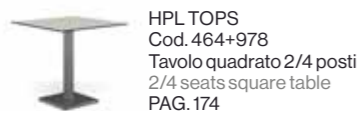

HPL TOPS  
Cod. 464+978  
Tavolo quadrato 2/4 posti  
2/4 seats square table  
PAG. 174



ROUND  
Cod. 475  
Tavolo alto 2 posti  
2 seats counter table  
PAG. 182



ROUND  
Cod. 477  
Tavolo basso  
Coffee table  
PAG. 258

# RONDA

Design by Aldo Ciabatti



Scansiona e scopri i progetti.  
Scan and discover the projects.



111  
Sedia  
Chair



116  
Poltroncina  
Armchair



128  
Sgabello  
Barstool



Fissaggio cuscino con laccetti.  
Cushion fastening with laces.

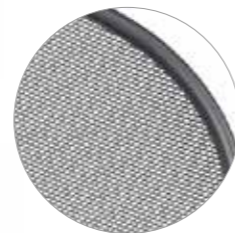

Lamiera stirata zincata a caldo.  
Hot-dip zincated expanded sheet.

## PRODOTTI—PRODUCTS

| Codice/Code<br>Tipologia/Typology | Disegno/Drawing | Info | TEST |
|-----------------------------------|-----------------|------|------|
|-----------------------------------|-----------------|------|------|

|  |  |  |  |
|--|--|--|--|
| 111<br>Sedia<br>Chair<br>W59 - D63 - H85<br>Kg 5,2 |  |  |  |
|--|--|--|--|

|   |  |  |                  |
|---|--|--|------------------|
| 116<br>Poltroncina<br>Armchair<br>W60 - D65 - H82<br>Kg 5,1 |  |  | EN581-1/ EN581-2 |
|---|--|--|------------------|

|   |  |  |  |
|---|--|--|--|
| 128<br>Sgabello<br>Barstool<br>W54 - D65 - H117<br>Kg 6,5 |  |  |  |
|---|--|--|--|

### COLORI STRUTTURA—FRAME COLORS

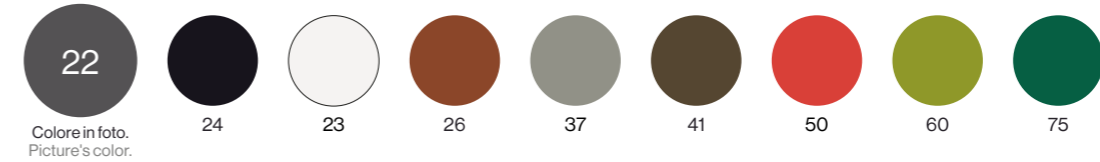

### CUSCINI—CUSHIONS

| Codice/Code<br>Tipologia/Typology   | Colori tessuto<br>Fabric colors | Categoria tessuto<br>Fabric category |
|---|---------------------------------|--------------------------------------|
| C/116<br>Cuscino seduta e schienale acrilico<br>Acrylic seat and back cushion<br>x cod. 111, 116, 128<br>W45 - D88 - H4<br>Kg 0,5 |                                 | Tessuti Basic<br>Basic Fabrics       |
| C/116S<br>Cuscino seduta acrilico<br>Acrylic seat cushion<br>x cod. 111, 116, 128<br>W45 - D44 - H4<br>Kg 0,25                    |                                 | Tessuti Basic<br>Basic Fabrics       |

\* Cuscino visibile in foto—Cushion in the picture

### COMBINAZIONI CONSIGLIATE—SUGGESTED MATCHINGS

88

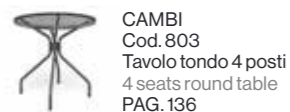

CAMBI  
Cod. 803  
Tavolo tondo 4 posti  
4 seats round table  
PAG. 136



NOVA  
Cod. 890  
Tavolo alto quadrato  
2 posti  
2 seats counter  
square table  
PAG. 142



TABLE SYSTEM  
Cod. 1156  
Tavolo bordo tondo  
5/6 posti  
5/6 seats round border table  
PAG. 192

## PLUS

• Lamiera saldata a proiezione su tubolare di struttura.—Spot welded sheet on tubular frame.

89

# RONDA X

Design by EMU



Scansiona e scopri i progetti.  
Scan and discover the projects.



457  
Sedia  
Chair



458  
Poltroncina  
Armchair



459  
Sgabello  
Barstool



Fissaggio cuscino con elastici e fermacorda.  
Cushion fastening with rubber band and clip.

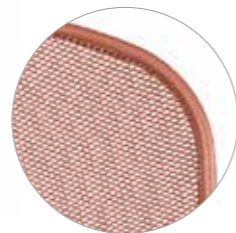

Lamiera stirata zincata a caldo utilizzata esclusivamente per la collezione Ronda X.  
Hot-dip zincated expanded sheet exclusively used for Ronda X collection.

## PRODOTTI—PRODUCTS

| Codice/Code<br>Tipologia/Typology                           | Disegno/Drawing | Info | TEST             |
|---|-----------------|------|------------------|
| 457<br>Sedia<br>Chair<br>W51,5 - D62 - H83<br>Kg 4,6        |                 |      | EN581-1/ EN581-2 |
| 458<br>Poltroncina<br>Armchair<br>W58 - D62 - H83<br>Kg 5,6 |                 |      | EN581-1/ EN581-2 |
| 459<br>Sgabello<br>Barstool<br>W51 - D52 - H101<br>Kg 5,6   |                 |      |                  |

### COLORI STRUTTURA—FRAME COLORS

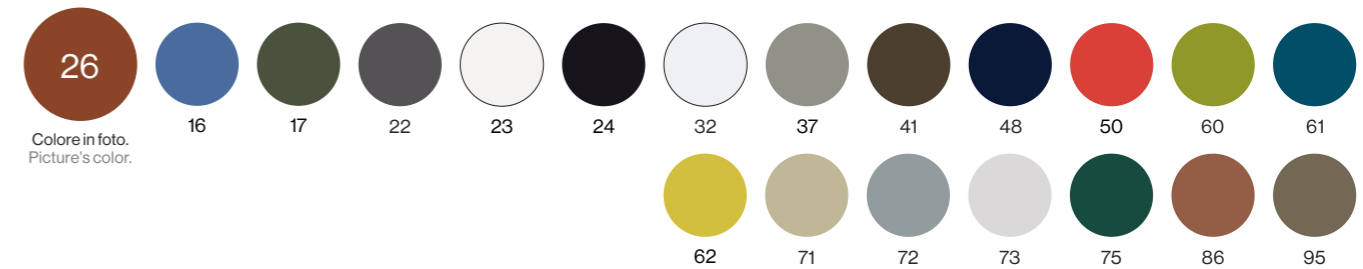

### CUSCINI—CUSHIONS

| Codice/Code<br>Tipologia/Typology   | Colori tessuto<br>Fabric colors | Categoria tessuto<br>Fabric category |
|---|---------------------------------|--------------------------------------|
| C/457**<br>Cuscino poliester<br>Polyester cushion<br>x cod. 457, 458<br>W44 - D45 - H2<br>Kg 0,25 |                                 | Cuscini Contract<br>Cuscini Contract |

\* Cuscino visibile in foto—Cushion in the picture

\*\* Cuscino utilizzabile sia per la seduta sia per lo schienale—Cushion fit for both seat and backrest use

### COMBINAZIONI CONSIGLIATE—SUGGESTED MATCHINGS

90



CAMBI  
Cod. 803  
Tavolo tondo 4 posti  
4 seats round table  
PAG. 136



ROUND  
Cod. 475  
Tavolo alto 2 posti  
2 seats counter table  
PAG. 182



TABLE SYSTEM  
Cod. 1156  
Tavolo bordo tondo  
5/6 posti  
5/6 seats round border table  
PAG. 192

## PLUS

- X come eXtra strong, eXtra simple, eXtra stylish.—X as eXtra strong, eXtra simple, eXtra stylish.
- La sagomatura longitudinale e trasversale di sedile e schienale rende la seduta estremamente confortevole.

Dimensioni più generose rispetto a Ronda con un minor ingombro a terra.

The longitudinal and transversal shape of the seat and backrest makes the seating extremely comfortable. Larger sizes than Ronda even saving space on floor.

- Tre volte più resistente agli stress meccanici di Ronda, è certificata CATAS.

Three times more resistant to mechanical stress than Ronda, it is CATAS certified.

- Realizzata in acciaio, materiale up-cycling, 100% riciclabile senza alcun degrado delle proprietà meccaniche.

Made of steel, up-cycling material, 100% recyclable without any deterioration of mechanical properties.

91

# ROUND

Design by Christophe Pillet



Scansiona e scopri i progetti.  
Scan and discover the projects.

465  
Sedia  
Chair



466  
Poltroncina  
Armchair



467  
Sgabello  
Barstool

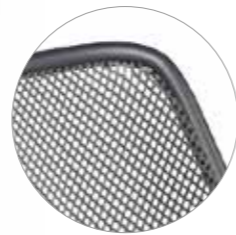

Lamiera stirata zincata a caldo. L'esclusiva sagomatura di sedile e schienale è realizzata tramite stampo di imbutitura e dà forma connotante al prodotto oltre che elevato comfort in uso. Hot-dip zinced expanded sheet. The exclusive moulding shape of the seat and backrest gives a connotative design and high comfort in use to the product.

## PRODOTTI—PRODUCTS

| Codice/Code<br>Tipologia/Typology                           | Disegno/Drawing | Info | TEST             |
|---|-----------------|------|------------------|
| 465<br>Sedia<br>Chair<br>W63 - D58 - H79<br>Kg 5,7          |                 |      | EN581-1/ EN581-2 |
| 466<br>Poltroncina<br>Armchair<br>W63 - D58 - H79<br>Kg 6,9 |                 |      |                  |
| 467<br>Sgabello<br>Barstool<br>W58 - D52 - H101<br>Kg 6,6   |                 |      |                  |

### COLORI STRUTTURA—FRAME COLORS

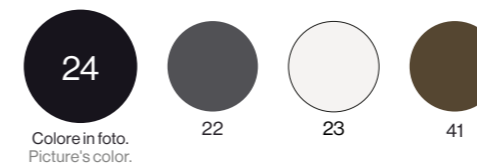

### CUSCINI—CUSHIONS

| Codice/Code<br>Tipologia/Typology   | Colori tessuto<br>Fabric colors | Categoria tessuto<br>Fabric category |
|---|---------------------------------|--------------------------------------|
| C/707<br>Cuscino universale poliestere<br>Polyester universal cushion<br>x cod. 465, 466<br>W44 - D38 - H2<br>Kg 0,23 |                                 | Cuscini Contract<br>Cuscini Contract |



# ROUND

Design by Christophe Pillet



Scansiona e scopri i progetti.  
Scan and discover the projects.

469  
Poltrona  
Lounge chair



## PRODOTTI—PRODUCTS

| Codice/Code<br>Tipologia/Typology | Disegno/Drawing | Info | TEST |
|-----------------------------------|-----------------|------|------|
|-----------------------------------|-----------------|------|------|

469

Poltrona  
Lounge chair  
W92 - D87 - H84  
Kg 9,4

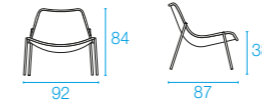

EN581-1/ EN581-2

### COLORI STRUTTURA—FRAME COLORS

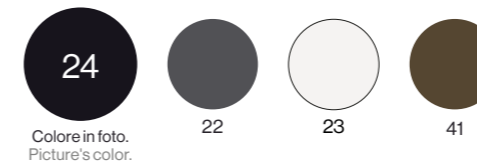

### CUSCINI—CUSHIONS

| Codice/Code<br>Tipologia/Typology  | Colori tessuto<br>Fabric colors | Categoria tessuto<br>Fabric category  |
|--|---------------------------------|---|
| <b>C/469</b><br>Cuscino seduta e schienale polipropilene<br>Polypropylene seat and back cushion<br>x cod. 469<br>W110 - D50/80/78 - H3<br>Kg 1,3 | 900/71<br>900/75<br>900/77      | Tessuti Standard<br>Standard Fabrics  |
| <b>C/701</b><br>Cuscino decorativo—Decorative cushion<br>x cod. 469<br>W40 - D40 - H15 Kg 0,7  |                                 | Tessuti Basic (Vedi riepilogo pg. 325)<br>Tessuti Standard (Vedi riepilogo pg. 325)<br>Tessuti Premium (Vedi riepilogo pg. 325)<br>Basic Fabrics (Look at pg. 325)<br>Standard Fabrics (Look at pg. 325)<br>Premium Fabrics (Look at pg. 325) |
| <b>C/705</b><br>Cuscino decorativo—Decorative cushion<br>x cod. 469<br>W45 - D35 - H15 Kg 0,6  |                                 |   |
| <b>C/706</b><br>Cuscino decorativo—Decorative cushion<br>x cod. 469<br>W60 - D40 - H20 Kg 0,8  |                                 |   |

### ALTRI PRODOTTI IN COLLEZIONE—OTHER COLLECTION'S PRODUCTS

94



ROUND  
Cod. 473  
Tavolo quadrato 2/4 posti  
2/4 seats square table  
PAG. 180



ROUND  
Cod. 475  
Tavolo alto 2 posti  
2 seats counter table  
PAG. 182



ROUND  
Cod. 477  
Tavolo basso  
Coffee table  
PAG. 258

## PLUS

• Fissaggio con elastico e corda per il cuscino C/469 della poltrona lounge.  
Cushion for the C/469 lounge chair with rubber band and rope fastening.

95

# SEGNO

Design by Aldo Ciabatti



Scansiona e scopri i progetti.  
Scan and discover the projects.



263  
Sedia  
Chair



268  
Poltroncina  
Armchair



264  
Sgabello  
Barstool



## PRODOTTI—PRODUCTS

| Codice/Code<br>Tipologia/Typology                           | Disegno/Drawing | Info |
|---|-----------------|------|
| 263<br>Sedia<br>Chair<br>W45 - D53 - H84<br>Kg 7,8          |                 |      |
| 268<br>Poltroncina<br>Armchair<br>W52 - D53 - H84<br>Kg 6,8 |                 |      |
| 264<br>Sgabello<br>Barstool<br>W50 - D54 - H102<br>Kg 9,0   |                 |      |

### COLORI STRUTTURA—FRAME COLORS

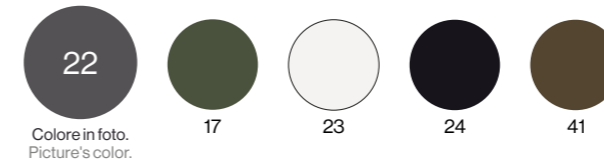

### CUSCINI—CUSHIONS

| Codice/Code<br>Tipologia/Typology  | Colori tessuto<br>Fabric colors                | Categoria tessuto<br>Fabric category   |
|--|--|--|
| C/710<br>Cuscino magnetico EMU-Tex quadrato<br>EMU-Tex square magnetic cushion<br>x cod. 263, 264, 268<br>W39 - D37 - H1,5 Kg 0,23 | 300/10<br>300/11<br>300/12                     | Cuscini Magnetici<br>Magnetic Cushions |
| C/703<br>Cuscino EMU acrilico quadrato<br>Acrylic EMU square cushion<br>x cod. 263, 264, 268<br>W38 - D38 - H2<br>Kg 0,13          | 700/4<br>700/10<br>700/12<br>700/13*<br>700/14 | Tessuti Basic<br>Basic Fabrics         |
| C/716<br>Cuscino universale poliesteri<br>Polyester universal cushion<br>x cod. 263, 264, 268<br>W40 - D38 - H2 Kg 0,19            | 500/28<br>500/29<br>500/30<br>500/31<br>500/51 | Cuscini Contract<br>Cushions Contract  |

\* Cuscino visibile in foto—Cushion in the picture

### PLUS

- Sedile e schienale in lamiera zincata a caldo per una migliore performance contro gli agenti atmosferici.  
Seat and backrest in hot-dip zincated sheet extremely resistant to weather conditions.
- Fessure di lamiera conformi a direttive di sicurezza internazionali.  
Sheet grooves in compliance with international safety regulations.

# SEGNO

Design by Aldo Ciabatti



Scansiona e scopri i progetti.  
Scan and discover the projects.

**267**  
Poltroncina con seduta in teak  
Armchair with teak seat

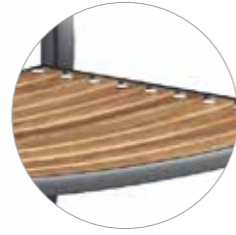

La poltroncina Segno è disponibile anche nella versione con sedile in teak FSC® per una seduta di grande valore, sostenibile e durevole sia da un punto di vista strutturale che estetico.

The Segno armchair is available also in the teak FSC® seat version. This is a valuable, sustainable seat, featured by a great durability structural but even aesthetic.

**158**  
Panca  
Bench



**159**  
Panca  
Bench



## PRODOTTI—PRODUCTS



| Codice/Code<br>Tipologia/Typology | Disegno/Drawing | Info | TEST |
|-----------------------------------|-----------------|------|------|
|-----------------------------------|-----------------|------|------|

**267**  
Poltroncina con seduta in teak  
Armchair with teak seat  
W52 - D53 - H84  
Kg 6,8

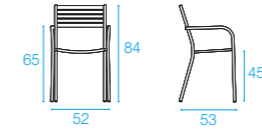

**158**  
Panca  
Bench  
W128 - D59 - H81  
Kg 26,2

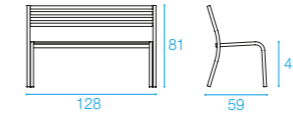

EN581-1/ EN581-2

**159**  
Panca  
Bench  
W168 - D59 - H81  
Kg 32,2

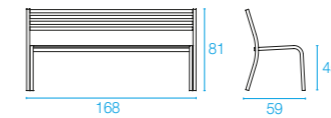

EN581-1/ EN581-2

### COLORI STRUTTURA/SEDUTA COD. 267—FRAME/SEAT COLORS X COD. 267

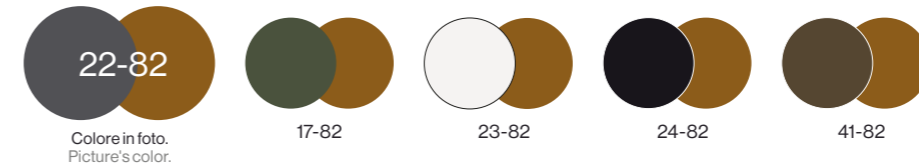

### COLORI STRUTTURA X COD. 158, 159—FRAME COLORS X COD. 158, 159

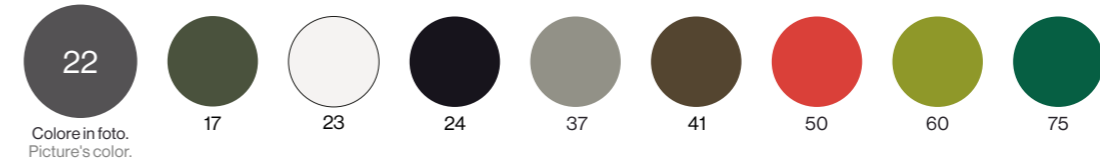

## CUSCINI—CUSHIONS

| Codice/Code<br>Tipologia/Typology | Colori tessuto<br>Fabric colors | Categoria tessuto<br>Fabric category |
|-----------------------------------|---------------------------------|--------------------------------------|
|-----------------------------------|---------------------------------|--------------------------------------|

**C/703**  
Cuscino EMU acrilico quadrato  
Acrylic EMU square cushion  
x cod. 267  
W38 - D38 - H2 Kg 0,13



|        |
|--------|
| 700/4  |
| 700/10 |
| 700/12 |
| 700/13 |
| 700/14 |

Tessuti Basic  
Basic Fabrics

**158/F**  
Kit fissaggio panca—Bench fixing kit  
x cod. 158, 159 Kg 0,20



### COMBINAZIONI CONSIGLIATE—SUGGESTED MATCHINGS



**STAR**  
Cod. 306  
Tavolo quadrato 4 posti  
4 seats square table  
PAG. 146



**HPL TOPS**  
Cod. 464+978  
Tavolo quadrato 2/4 posti  
2/4 seats square table  
PAG. 174



**NOVA**  
Cod. 890  
Tavolo alto quadrato 2 posti  
2 seats counter square table  
PAG. 142

# SHINE

Design by Arik Levy



Scansiona e scopri i progetti.  
Scan and discover the projects.



247  
Sedia  
Chair



248  
Poltroncina  
Armchair



Sedile e schienale in lamiera stampata di alluminio ad alte resistenze meccaniche, ideale contro lo stress in uso tipico dei contesti contract.  
Seat and backrest made of moulded aluminium sheet with high static load resistance, ideal to support the usual overloaded of contract contexts.



253  
Sgabello  
Barstool



Cuscino sfoderabile in tessuto. Fissaggio con elastico e particolare a incastro.  
Cover removable fabric cushion. Fastening system with rubber band and interlocking detail.

## PRODOTTI—PRODUCTS

| Codice/Code<br>Tipologia/Typology                           | Disegno/Drawing | Info | TEST             |
|---|-----------------|------|------------------|
| 247<br>Sedia<br>Chair<br>W50 - D55 - H78<br>Kg 4,7          |                 |      | EN581-1/ EN581-2 |
| 248<br>Poltroncina<br>Armchair<br>W60 - D57 - H78<br>Kg 5,8 |                 |      | EN581-1/ EN581-2 |
| 253<br>Sgabello<br>Barstool<br>W54 - D57 - H97<br>Kg 5,7    |                 |      | EN581-1/ EN581-2 |

### COLORI STRUTTURA/SEDUTA X COD. 247, 253—FRAME/SEAT COLORS X COD. 247, 253

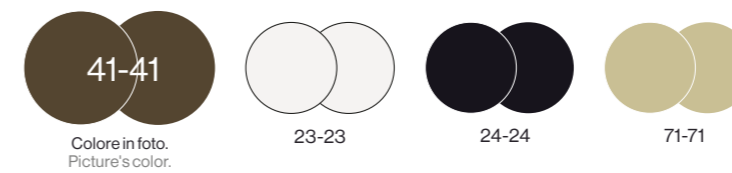

### COLORI STRUTTURA/SEDUTA/BRACCIOLI X COD. 248—FRAME/SEAT/ARMRESTS COLORS X COD. 248

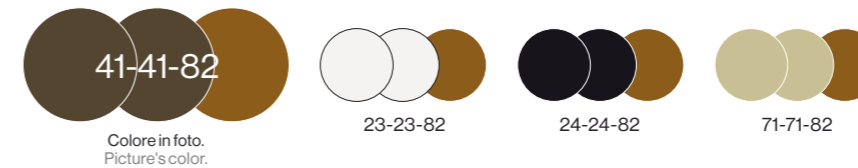

## CUSCINI—CUSHIONS

| Codice/Code<br>Tipologia/Typology   | Colori tessuto<br>Fabric colors | Categoria tessuto<br>Fabric category |
|---|---------------------------------|--------------------------------------|
| C/247<br>Cuscino seduta polipropilene<br>Polypropylene seat cushion<br>x cod. 247, 248, 253<br>W36/40 - D40 - H2<br>Kg 0,22 | <br>900/71<br>900/75*<br>900/77 | Tessuti Standard<br>Standard Fabrics |

\* Cuscino visibile in foto—Cushion in the picture

## PLUS

- I giunti dello schienale, in pressofusione di alluminio, con il loro design contribuiscono in maniera determinante all'estetica del prodotto.—The design of the die-cast aluminium backrest joints refines the aesthetics of the product.
- Il tubo estruso di sezione rettangolare in lega di alluminio denota una specifica scelta di carattere del disegno.—The extruded rectangular pipe in aluminium alloy defines a specific choice in terms of design.

# SHINE

Design by Arik Levy



Scansiona e scopri i progetti.  
Scan and discover the projects.

249  
Poltrona  
Lounge  
chair



Braccioli in teak FSC® che arricchiscono il prodotto con materiali sostenibili e dalle nuance naturali.  
FSC® Teak armrests that enrich the product with sustainable materials and natural nuances.



Doppio schienale piegato per agevolare il comfort in ogni posto seduta.  
Double folded backrest to increase comfort in each seat.

260  
Divano  
Sofa



## PRODOTTI—PRODUCTS



| Codice/Code<br>Tipologia/Typology | Disegno/Drawing | Info | TEST |
|-----------------------------------|-----------------|------|------|
|-----------------------------------|-----------------|------|------|

|   |  |  |                  |
|---|--|--|------------------|
| 249<br>Poltrona<br>Lounge chair<br>W77 - 65 - H72<br>Kg 7,0 |  |  | EN581-1/ EN581-2 |
|---|--|--|------------------|

|   |  |  |                  |
|---|--|--|------------------|
| 260<br>Divano<br>Sofa<br>W147 - 65 - H71<br>Kg 18,5 |  |  | EN581-1/ EN581-2 |
|---|--|--|------------------|

### COLORI STRUTTURA/SEDUTA/BRACCIOLI X COD. 249—FRAME/SEAT/ARMRESTS COLORS X COD. 249

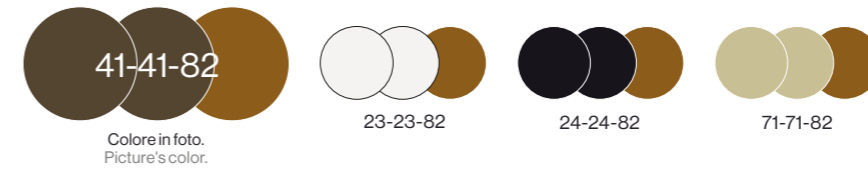

### COLORI STRUTTURA E SEDUTA/BRACCIOLI X COD. 260 FRAME AND SEAT/ARMRESTS COLORS X COD. 260

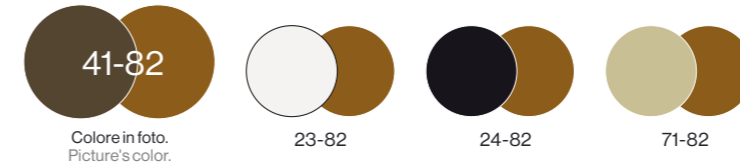

## CUSCINI—CUSHIONS

| Codice/Code<br>Tipologia/Typology  | Colori tessuto<br>Fabric colors | Categoria tessuto<br>Fabric category |
|--|---------------------------------|--------------------------------------|
| C/249<br>Cuscino seduta polipropilene<br>Polypropylene seat cushion<br>x cod. 249, 260<br>W47/53 - D48 - H2<br>Kg 0,34 | 900/71<br>900/75*<br>900/77     | Tessuti Standard<br>Standard Fabrics |

\* Cuscino visibile in foto—Cushion in the picture



Scansiona e scopri i progetti.  
Scan and discover the projects.

247  
Sedia  
Chair



248  
Poltroncina  
Armchair



253  
Sgabello  
Barstool



Sedile in teak FSC® per un piacevole effetto tattile e visivo.  
Teak FSC® seat for a pleasant touch, look and feel.

## PRODOTTI—PRODUCTS



| Codice/Code<br>Tipologia/Typology                           | Disegno/Drawing | Info | TEST             |
|---|-----------------|------|------------------|
| 247<br>Sedia<br>Chair<br>W50 - D55 - H78<br>Kg 5,3          |                 |      | EN581-1/ EN581-2 |
| 248<br>Poltroncina<br>Armchair<br>W60 - D57 - H78<br>Kg 6,3 |                 |      | EN581-1/ EN581-2 |
| 253<br>Sgabello<br>Barstool<br>W54 - D57 - H97<br>Kg 5,9    |                 |      | EN581-1/ EN581-2 |

### COLORI STRUTTURA/SEDUTA X COD. 247, 253—FRAME/SEAT COLORS X COD. 247, 253

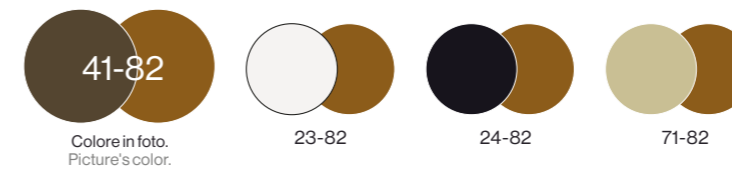

### COLORI STRUTTURA/SEDUTA/BRACCIOLI X COD. 248—FRAME/SEAT/ARMRESTS COLORS X COD. 248



## CUSCINI—CUSHIONS

| Codice/Code<br>Tipologia/Typology   | Colori tessuto<br>Fabric colors | Categoria tessuto<br>Fabric category |
|---|---------------------------------|--------------------------------------|
| C/247<br>Cuscino seduta polipropilene<br>Polypropylene seat cushion<br>x cod. 247, 248, 253<br>W36/40 - D40 - H2<br>Kg 0,22 | <br>900/71<br>900/75<br>900/77  | Tessuti Standard<br>Standard Fabrics |

## PLUS

• Al caratteristico disegno del prodotto si aggiunge la nota naturale e sofisticata del teak che apre ad un utilizzo più trasversale anche in ambienti indoor.—The natural and sophisticated teak nuance enhances the characteristic design of the product and make the collection even suitable to indoor contexts.



Scansiona e scopri i progetti.  
Scan and discover the projects.

249  
Poltrona  
Lounge chair



## PRODOTTI—PRODUCTS



| Codice/Code<br>Tipologia/Typology | Disegno/Drawing | Info | TEST |
|-----------------------------------|-----------------|------|------|
|-----------------------------------|-----------------|------|------|

249

Poltrona  
Lounge chair  
W77 - 65 - H72  
Kg 8,5

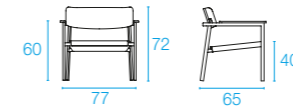

EN581-1/ EN581-2



COLORI STRUTTURA/SEDUTA/BRACCIOLI X COD. 249—FRAME/SEAT/ARMRESTS COLORS X COD. 249



## CUSCINI—CUSHIONS

| Codice/Code<br>Tipologia/Typology  | Colori tessuto<br>Fabric colors  | Categoria tessuto<br>Fabric category |
|--|--|--------------------------------------|
| C/249<br>Cuscino seduta polipropilene<br>Polypropylene seat cushion<br>x cod. 249, 260<br>W47/53 - D48 - H2<br>Kg 0,34 | <div style="border: 1px solid black; padding: 2px;">900/71</div> <div style="border: 1px solid black; padding: 2px;">900/75</div> <div style="border: 1px solid black; padding: 2px;">900/77</div> | Tessuti Standard<br>Standard Fabrics |



### ALTRI PRODOTTI IN COLLEZIONE—OTHER COLLECTION'S PRODUCTS



SHINE  
Cod. 252  
Tavolo basso  
Coffee table  
PAG. 260



SHINE  
Cod. 254+257  
Tavolo 2/4 posti con piano  
in teak  
2/4 seats table with teak  
top  
PAG. 184



SHINE  
Cod. 255+258  
Tavolo alto 2 posti  
con piano in HPL  
2 seats counter table  
with HPL top  
PAG. 184

# SNOOZE

Design by Chiaramonte—Marin



Scansiona e scopri i progetti.  
Scan and discover the projects.

213  
Sedia regista  
Director's chair



Sedile e schienale in EMU-Tex con imbottitura in fibra resinata per aumentarne il comfort durante l'utilizzo.  
EMU-Tex seat and backrest with resin fiber padding to increase comfort during the use.



## PRODOTTI—PRODUCTS



| Codice/Code<br>Tipologia/Typology | Disegno/Drawing | Info |
|-----------------------------------|-----------------|------|
|-----------------------------------|-----------------|------|

213  
Sedia regista  
Director's chair  
W61 - D60 - H80  
Kg 7,8

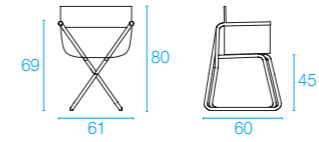

### COLORI STRUTTURA/SEDUTA E SCHIENALE—FRAME/SEAT AND BACK COLORS

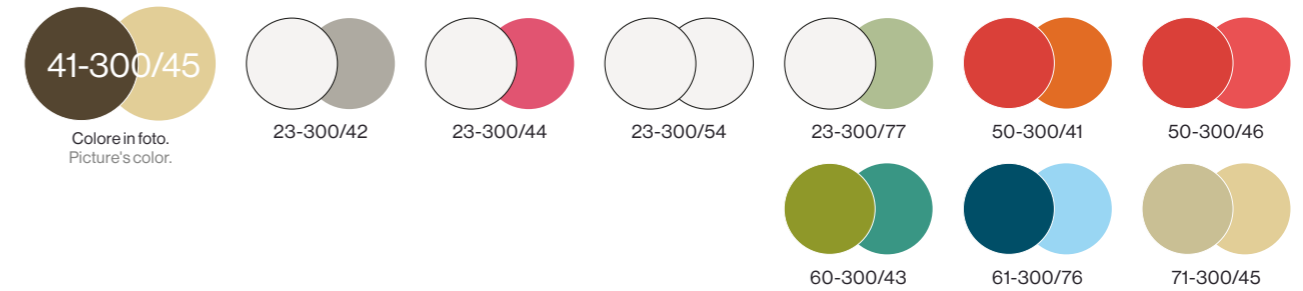

Le immagini dei colori sono a scopo illustrativo. Per vedere la trama degli EMU-Tex, consultare pg. 341.  
All colors images shown are for illustration purposes only. Look at pg. 341 to see the texture of the EMU-Tex.

### ALTRI PRODOTTI IN COLLEZIONE—OTHER COLLECTION'S PRODUCTS

108



SNOOZE  
Cod. 201  
Sdraio  
Deck chair  
PAG. 278



SNOOZE  
Cod. 204  
Poggiapiedi  
Foot stool  
PAG. 278



SNOOZE  
Cod. 207  
Lettino impilabile  
Stackable sunbed  
PAG. 278

## PLUS

- Struttura in tubolare di acciaio zincato particolarmente performante in ambienti esterni e resistente agli agenti atmosferici.—Frame in zincated tubular steel particularly performing in outdoor environments and resistant to weathering.
- EMU-Tex disponibile in un'ampia gamma colori.—EMU-Tex available in a wide range of colors.
- La completezza di elementi dining e lounge rende la collezione Snooze trasversale ai più svariati contesti contract.—Snooze collection includes both dining and relaxing products and become suitable to a great variety of contract contexts.

109





Scansiona e scopri i progetti.  
Scan and discover the projects.



3402  
Sedia  
Chair

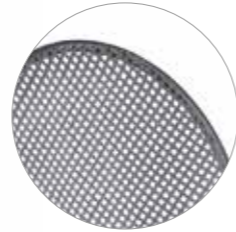

Seduta e schienale in lamiera finto intreccio zincata a caldo.  
Seat and backrest in hot-dip zincated sheet. Simulated woven wire mesh.

3403  
Poltroncina  
Armchair



Fissaggio cuscino C/704 con laccetti.  
Cushion C/704 fastening with laces.

## COMBINAZIONI CONSIGLIATE—SUGGESTED MATCHINGS



CAMBI  
Cod. 803  
Tavolo tondo 4 posti  
4 seats round table  
PAG. 136



TABLESYSTEM  
Cod. 1156  
Tavolo bordo tondo 5/6 posti  
5/6 seats round border table  
PAG. 192



STAR  
Cod. 306  
Tavolo quadrato 4 posti  
4 seats square table  
PAG. 146

## PRODOTTI—PRODUCTS

| Codice/Code<br>Tipologia/Typology | Disegno/Drawing | Info |
|-----------------------------------|-----------------|------|
|-----------------------------------|-----------------|------|

3402

Sedia  
Chair  
W48 - D62 - H88  
Kg 5,4

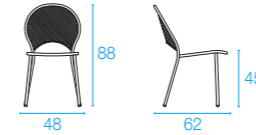

3403

Poltroncina  
Armchair  
W58 - D62 - H88  
Kg 6,4

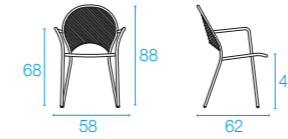

### COLORI STRUTTURA—FRAME COLORS

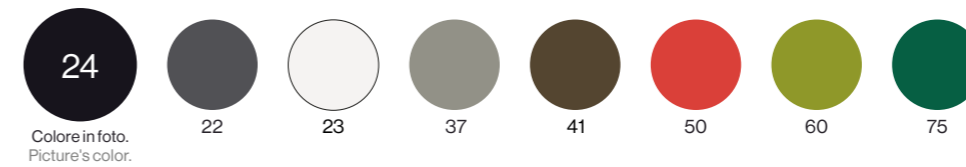

## CUSCINI—CUSHIONS

| Codice/Code<br>Tipologia/Typology  | Colori tessuto<br>Fabric colors                | Categoria tessuto<br>Fabric category   |
|--|--|--|
| C/711<br>Cuscino magnetico EMU-Tex tondo<br>EMU-Tex round magnetic cushion<br>x cod. 3402, 3403<br>ø38 - H1,5<br>Kg 0,17 | 300/10<br>300/11<br>300/12                     | Cuscini Magnetici<br>Magnetic Cushions |
| C/704<br>Cuscino EMU acrilico tondo<br>Acrylic EMU round cushion<br>x cod. 3402, 3403<br>ø38,5 - H2<br>Kg 0,11           | 700/4<br>700/10<br>700/12*<br>700/13<br>700/14 | Tessuti Basic<br>Basic Fabrics         |

\* Cuscino visibile in foto—Cushion in the picture

## PLUS

- Lamiera saldata a proiezione per una maggiore precisione estetica.  
Spot welded sheet for greater aesthetic precision.
- Cuscino magnetico C/711 con calamita.—C/711 magnetic cushion.



161  
Sedia  
Chair



Il sedile in lamiera stampata di sedia e poltroncina viene sagomato anteriormente per un maggior comfort delle gambe in uso.  
The moulded seat of chair and armchair is frontally shaped for a greater comfort in use.

162  
Poltroncina  
Armchair

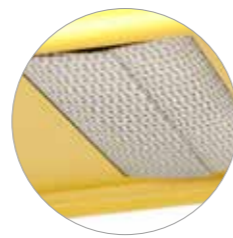

Cuscino sfoderabile C/161 in tessuto, con fissaggio tramite velcro.  
C/161 cover removable cushion with velcro fastening.

## PRODOTTI—PRODUCTS

| Codice/Code<br>Tipologia/Typology                           | Disegno/Drawing | Info | TEST             |
|---|-----------------|------|------------------|
| 161<br>Sedia<br>Chair<br>W54 - D61 - H81<br>Kg 7,0          |                 |      | EN581-1/ EN581-2 |
| 162<br>Poltroncina<br>Armchair<br>W58 - D61 - H81<br>Kg 7,6 |                 |      | EN581-1/ EN581-2 |

### COLORI STRUTTURA—FRAME COLORS

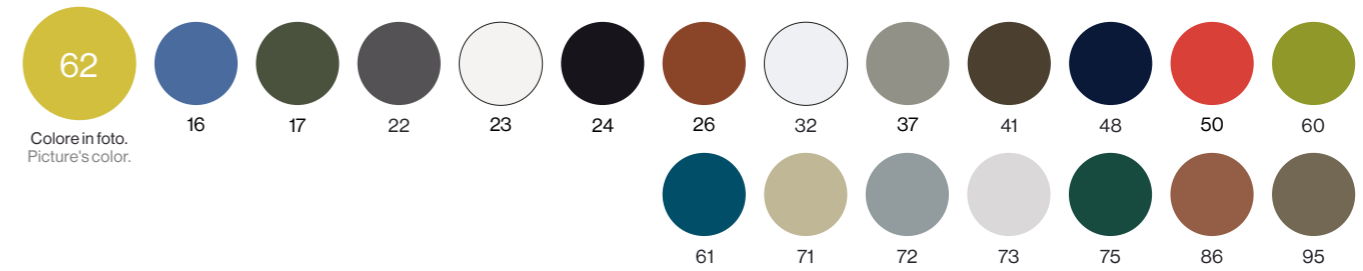

### CUSCINI—CUSHIONS

| Codice/Code<br>Tipologia/Typology   | Colori tessuto<br>Fabric colors | Categoria tessuto<br>Fabric category   |
|---|---------------------------------|--|
| C/161<br>Cuscino seduta acrilico<br>Acrylic seat cushion<br>x cod. 161, 162<br>W41 - D38 - H2,5 Kg 0,26                       |                                 | Tessuti Basic<br>Basic Fabrics         |
| C/162<br>Cuscino schienale acrilico<br>Acrylic back cushion<br>x cod. 161, 162<br>W41 - D17 - H2,5 Kg 0,14                    |                                 | Tessuti Basic<br>Basic Fabrics         |
| C/703<br>Cuscino EMU acrilico quadrato<br>Acrylic EMU square cushion<br>x cod. 161, 162<br>W38 - D38 - H2 Kg 0,13             |                                 | Tessuti Basic<br>Basic Fabrics         |
| C/710<br>Cuscino magnetico EMU-Tex quadrato<br>EMU-Tex square magnetic cushion<br>x cod. 161, 162<br>W39 - D37 - H1,5 Kg 0,23 |                                 | Cuscini Magnetici<br>Magnetic Cushions |
| C/716<br>Cuscino universale poliestere<br>Polyester universal cushion<br>x cod. 161, 162<br>W40 - D38 - H2 Kg 0,19            |                                 | Cuscini Contract<br>Cushions Contract  |

\* Cuscino visibile in foto—Cushion in the picture



164  
Sgabello  
Barstool



Lamiera sedile rinforzata nella parte posteriore tramite nervatura realizzata da stampaggio.  
Reinforced seat sheet in the back by ribbing made by moulding.

163  
Panca  
Bench



## PRODOTTI—PRODUCTS



| Codice/Code<br>Tipologia/Typology | Disegno/Drawing | Info |
|-----------------------------------|-----------------|------|
|-----------------------------------|-----------------|------|

|   |  |  |
|---|--|--|
| 164<br>Sgabello<br>Barstool<br>W56 - D59 - H105<br>Kg 8,2 |  |  |
|---|--|--|

|  |  |  |
|--|--|--|
| 163<br>Panca<br>Bench<br>W118 - D62 - H81<br>Kg 14,7 |  |  |
|--|--|--|

### COLORI STRUTTURA—FRAME COLORS

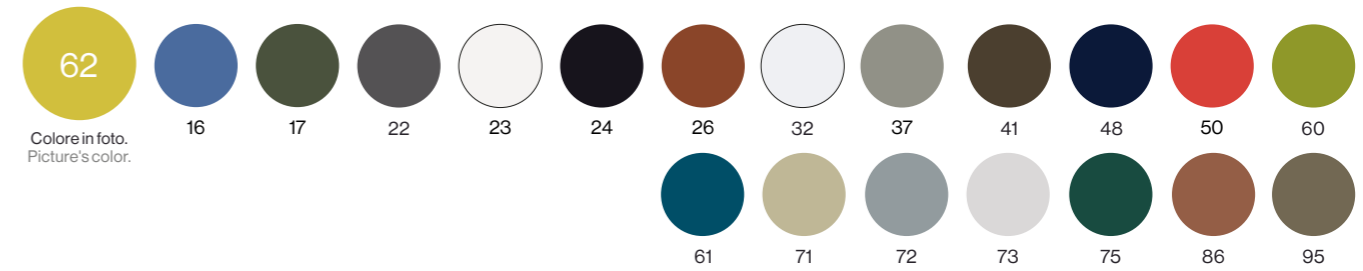

### CUSCINI—CUSHIONS

| Codice/Code<br>Tipologia/Typology  | Colori tessuto<br>Fabric colors | Categoria tessuto<br>Fabric category   |
|--|---------------------------------|--|
| C/703<br>Cuscino EMU acrilico quadrato<br>Acrylic EMU square cushion<br>x cod. 164<br>W38 - D38 - H2 Kg 0,13             |                                 | Tessuti Basic<br>Basic Fabrics         |
| C/710<br>Cuscino magnetico EMU-Tex quadrato<br>EMU-Tex square magnetic cushion<br>x cod. 164<br>W39 - D37 - H1,5 Kg 0,23 |                                 | Cuscini Magnetici<br>Magnetic Cushions |
| C/716<br>Cuscino universale poliestere<br>Polyester universal cushion<br>x cod. 164<br>W40 - D38 - H2 Kg 0,19            |                                 | Cuscini Contract<br>Cuscini Contract   |

### PLUS

- Sedile e schienale in lamiera zincata a caldo imbutita.  
Seat and backrest in deep-drawn hot-dip zinced steel sheet.
- Cuscino sfoderabile C/703 in tessuto acrilico dotato di fissaggio con laccetti. Cuscino C/710 magnetico dotato di fissaggio con calamita. Cuscino C/716 con antiscivolo.— C/703 cover removable cushion in acrylic fabric with laces fastening. C/710 magnetic cushion. C/716 non-slip cushion.



Scansiona e scopri i progetti.  
Scan and discover the projects.

**165**  
Poltrona  
Lounge chair



**166**  
Divano  
Sofa



## PRODOTTI—PRODUCTS

| Codice/Code<br>Tipologia/Typology  | Disegno/Drawing | Info | TEST         |
|--|-----------------|------|--------------|
| <b>165</b><br>Poltrona<br>Lounge chair<br>W73,5 - D69,5 - H74<br>Kg 10,8 |                 |      | UNI EN 16139 |
| <b>166</b><br>Divano<br>Sofa<br>W129 - D69,5 - H74<br>Kg 18,4            |                 |      | UNI EN 16139 |

### COLORI STRUTTURA—FRAME COLORS

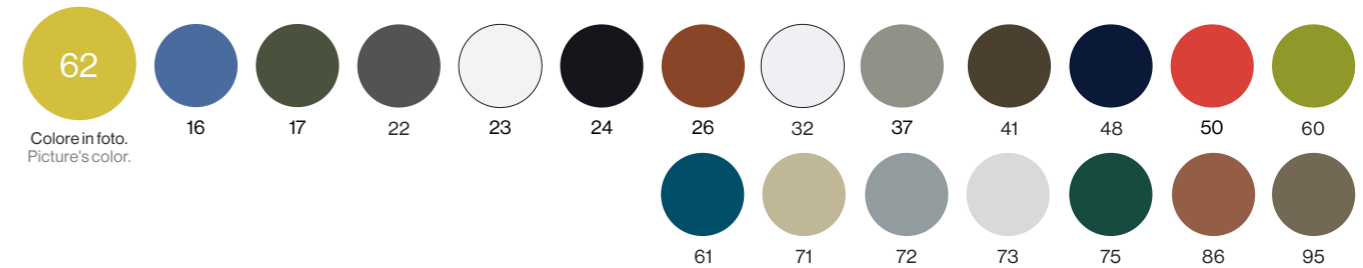

### CUSCINI—CUSHIONS

| Codice/Code<br>Tipologia/Typology   | Colori tessuto<br>Fabric colors | Categoria tessuto<br>Fabric category   |
|---|---------------------------------|--|
| <b>C/713</b><br>Cuscino magnetico EMU-Tex poltrona<br>EMU-Tex lounge chair magnetic cushion<br>x cod. 165, 166<br>W53 - D44 - H1,5 Kg 0,3 | <br>300/10<br>300/11<br>300/12  | Cuscini Magnetici<br>Magnetic Cushions |

### ALTRI PRODOTTI IN COLLEZIONE—OTHER COLLECTION'S PRODUCTS



STAR  
Cod. 305  
Tavolo quadrato 2 posti  
2 seats square table  
PAG. 146



STAR  
Cod. 306  
Tavolo quadrato 4 posti  
4 seats square table  
PAG. 146



ROUND  
Cod. 482  
Tavolo snack  
Snack table  
PAG. 258

## PLUS

• Cuscini per la poltrona con fissaggio magnetico.—Cushions for the lounge chair with magnetic fastening.  
• La completezza di elementi dining e lounge, oltre all'ampia gamma di colori disponibili, rende la collezione Star trasversale ai più svariati contesti contract.—Star collection includes not only dining and relaxing products but also a wide colors range. That's why it's suitable to a great variety of contract contexts.



Scansiona e scopri i progetti.  
Scan and discover the projects.



1361  
Sedia  
Chair



1362  
Poltroncina  
Armchair



1363  
Poltrona  
Lounge chair



Sagomatura tramite stampo per la sedia e poltrona per un maggior comfort delle gambe in uso.  
Shaping by mould for the chair and armchair for a greater comfort in use.

Struttura in lega di alluminio rinforzata internamente con tubi di acciaio zincato.  
Aluminium alloy frame reinforced internally with hot-dip zincated pipes.

## PRODOTTI—PRODUCTS

| Codice/Code<br>Tipologia/Typology                                 | Disegno/Drawing | Info |
|---|-----------------|------|
| 1361<br>Sedia<br>Chair<br>W54 - D61 - H81<br>Kg 4,2               |                 |      |
| 1362<br>Poltroncina<br>Armchair<br>W58 - D61 - H81<br>Kg 4,6      |                 |      |
| 1363<br>Poltrona<br>Lounge chair<br>W73,5 - D69,5 - H74<br>Kg 6,3 |                 |      |

### COLORI STRUTTURA—FRAME COLORS

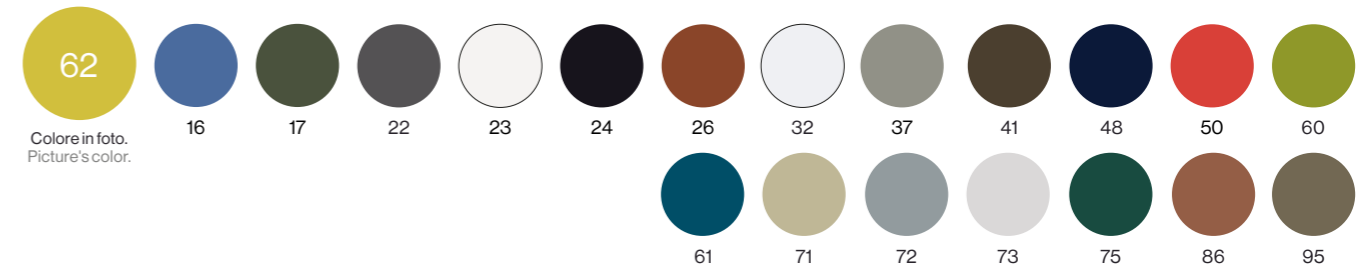

### CUSCINI—CUSHIONS

| Codice/Code<br>Tipologia/Typology  | Colori tessuto<br>Fabric colors | Categoria tessuto<br>Fabric category |
|--|---------------------------------|--------------------------------------|
| C/161<br>Cuscino seduta acrilico<br>Acrylic seat cushion<br>x cod. 1361, 1362<br>W41 - D38 - H2,5 Kg 0,26            |                                 | Tessuti Basic<br>Basic Fabrics       |
| C/162<br>Cuscino schienale acrilico<br>Acrylic back cushion<br>x cod. 1361, 1362<br>W41 - D17 - H2,5 Kg 0,14         |                                 | Tessuti Basic<br>Basic Fabrics       |
| C/703<br>Cuscino EMU acrilico quadrato<br>Acrylic EMU square cushion<br>x cod. 1361, 1362<br>W38 - D38 - H2 Kg 0,13  |                                 | Tessuti Basic<br>Basic Fabrics       |
| C/716<br>Cuscino universale poliestere<br>Polyester universal cushion<br>x cod. 1361, 1362<br>W40 - D38 - H2 Kg 0,19 |                                 | Cuscini Contract<br>Cuscini Contract |

### COMBINAZIONI CONSIGLIATE—SUGGESTED MATCHINGS

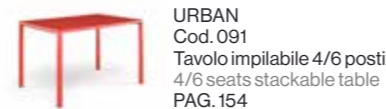
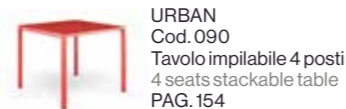
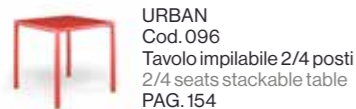

## PLUS

• Il nostro best seller Star evolve e diventa anche di alluminio per offrire ulteriori garanzie in prossimità del mare e piscine.— Our best seller Star has evolved in aluminium, for a better performance near the sea and swimming pools.  
• Particolarmente adeguata ad usi contract dove è richiesta maggiore resistenza e leggerezza.  
It is particularly suitable for contract uses where greater strength and lightness are required.



728  
Poltroncina  
Armchair



Struttura in tubolare di alluminio e giunti in pressofusione di alluminio per un'estetica più definita.  
Frame in aluminium profiles.  
Die-cast aluminium joints of great finish and aesthetic refinement.

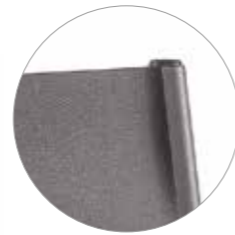

Lo schienale in ecopelle, con la sua flessibilità, asseconda la posizione della seduta in uso.  
The eco-leather backrest, with its flexibility, follows the position of the seat in use.

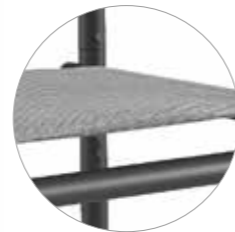

Sedile in EMU-Tex dotato di imbottitura interna per un maggior comfort.  
EMU-Tex seat with inner padding for a better comfort.



## PRODOTTI—PRODUCTS

| Codice/Code<br>Tipologia/Typology | Disegno/Drawing | Info | TEST |
|-----------------------------------|-----------------|------|------|
|-----------------------------------|-----------------|------|------|

728  
Poltroncina  
Armchair  
W61 - D53 - H79  
Kg 4,8

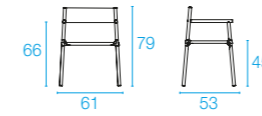

EN581-1/ EN581-2

### COLORI STRUTTURA/SCHIENALE/SEDUTA—FRAME/BACK/SEAT COLORS

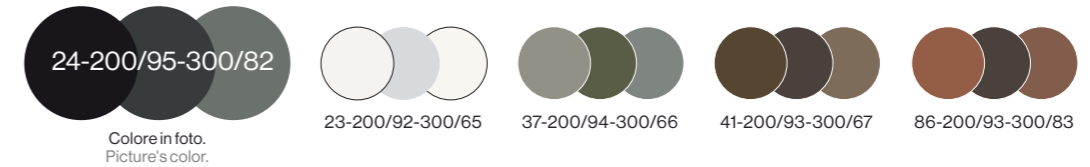

Le immagini dei colori sono a scopo illustrativo. Per vedere la trama degli EMU-Tex, consultare pg. 341.  
All colors images shown are for illustration purposes only. Look at pg. 341 to see the texture of the EMU-Tex.

### ALTRI PRODOTTI IN COLLEZIONE—OTHER COLLECTION'S PRODUCTS



TERRAMARE  
Cod. 729+C/729  
Poltrona  
Lounge chair  
PAG. 232



TERRAMARE  
Cod. 727  
Lettino impilabile  
Stackable sunbed  
PAG. 282



TERRAMARE  
Cod. 733+736P  
Tavolo basso medio  
Medium coffee table  
PAG. 262

## PLUS

- Il naturale invecchiamento dell'ecopelle, così come avviene per la pelle naturale, conferisce al prodotto un carattere distintivo ed affascinante.—The eco-leather recalls the beauty of natural leather and, like this one, has a natural ageing in use that increases its distinctive character and charm.
- La completezza di sedute dining e lounge, oltre alla varietà di tavoli bassi in abbinamento, rende la collezione Terramare trasversale ai più svariati contesti contract.—Terramare collection includes not only dining and lounge seating but also a wide range of coffee tables to combine with. That's why it's suitable to a great variety of contract contexts.



Scansiona e scopri i progetti.  
Scan and discover the projects.

655  
Sedia  
Chair



La seduta Thor può essere impreziosita e resa più confortevole dall'applicazione dell'accessorio sedile in teak FSC®. Tale accessorio, dotato di un facile sistema di aggancio, dà valore aggiunto alla seduta sia da un punto di vista strutturale che estetico.—Thor chair could become more comfortable and elegant thanks to the teak FSC® seat available as accessory. This element gives to the seat a structural but even aesthetic added value.

657  
Sgabello  
Barstool



Gli sgabelli sia alti che dining sono dotati di un elemento in PVC di protezione poggiatesta contro i graffi a cui il prodotto è sottoposto dopo un uso prolungato.—High and dining stools are provided with a PVC footrest element against scratches due to an extended use.

658  
Sgabello basso  
Dining stool



Cuscino C/655 in poliestere con pratico fissaggio a clip, solo per la versione in acciaio.—C/655 polyester cushion with handy clip fastening, only for steel seat version.

## ALTRI PRODOTTI IN COLLEZIONE—OTHER COLLECTION'S PRODUCTS



THOR  
Cod. 900  
Tavolo tondo 2 posti  
2 seats round table  
PAG. 202



THOR  
Cod. 902  
Tavolo tondo 2/4 posti  
2/4 seats round table  
PAG. 202

## PRODOTTI—PRODUCTS



| Codice/Code<br>Tipologia/Typology                              | Disegno/Drawing | Info | TEST             |
|--|-----------------|------|------------------|
| 655<br>Sedia<br>Chair<br>W52 - D55 - H80 Kg 6,3                |                 |      | EN581-1/ EN581-2 |
| 657<br>Sgabello<br>Barstool<br>W48 - D48 - H75 Kg 6,9          |                 |      | EN581-1/ EN581-2 |
| 658<br>Sgabello basso<br>Dining stool<br>W46 - 46 - H45 Kg 5,5 |                 |      | EN581-1/ EN581-2 |

## COLORI STRUTTURA—FRAME COLORS

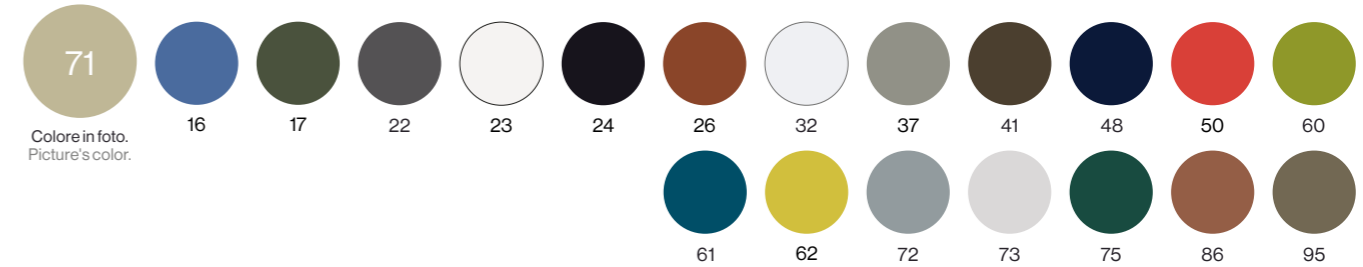

## SEDILE IN TEAK/CUSCINI—TEAK SEAT/CUSHIONS

| Codice/Code<br>Tipologia/Typology   | Colori tessuto<br>Fabric colors                 | Categoria tessuto<br>Fabric category   |
|---|---|--|
| 659<br>Sedile in teak—Teak seat<br>x cod. 655, 657, 658<br>W35,5 - D35,5 - H2 Kg 1,26   | 82  |  |
| C/655<br>Cuscino seduta poliestere (solo per seduta in acciaio)<br>Polyester seat cushion (only for steel seat)<br>x cod. 655, 657, 658<br>W37 - D37 - H2 Kg 0,17                 | 500/28<br>500/29*<br>500/30<br>500/31<br>500/51 | Cuscini Contract<br>Cuscini Contract   |
| C/709<br>Cuscino universale poliestere<br>Polyester universal cushion<br>x cod. 655, 657, 658<br>W37 - D37 - H2 Kg 0,17   | 500/28<br>500/29<br>500/30<br>500/31<br>500/51  | Cuscini Contract<br>Cuscini Contract   |
| C/711<br>Cuscino magnetico EMU-Tex tondo<br>(solo per seduta in acciaio)<br>EMU-Tex round magnetic cushion<br>(only for steel seat)<br>x cod. 655, 657, 658<br>ø38 - H1,5 Kg 0,17 | 300/10<br>300/11<br>300/12                      | Cuscini Magnetici<br>Magnetic Cushions |

\* Cuscino visibile in foto—Cushion in the picture

## PLUS

• Sedile in lamiera stampata e struttura in tubo di acciaio zincato a caldo.—Moulded seat and frame made of hot-dip zincated steel pipe.  
• Il design ispirato alle lavorazioni artigianali del metallo forgiato definisce il carattere di questa collezione e la rende particolarmente adatta ad ambienti contract dallo stile classico.—The design inspired by hand-forged metal crafts defines the personality of this collection and makes it especially suitable to classic contract contexts.

# URBAN

Design by Samuel Wilkinson



Scansiona e scopri i progetti.  
Scan and discover the projects.

208  
Sedia  
Chair



209  
Poltroncina  
Armchair



Il tubolare di alluminio a sezione quadrata connota il carattere di questa linea di sedute.  
Line of seats characterized by the tubular aluminium with square section.

211  
Sgabello  
Barstool



## ALTRI PRODOTTI IN COLLEZIONE—OTHER COLLECTION'S PRODUCTS



URBAN  
Cod. 096  
Tavolo impilabile 2/4 posti  
2/4 seats stackable table  
PAG. 154



URBAN  
Cod. 090  
Tavolo impilabile 4 posti  
4 seats stackable table  
PAG. 154



URBAN  
Cod. 091  
Tavolo impilabile 4/6 posti  
4/6 seats stackable table  
PAG. 154

## PRODOTTI—PRODUCTS

| Codice/Code<br>Tipologia/Typology                           | Disegno/Drawing | Info | TEST             |
|---|-----------------|------|------------------|
| 208<br>Sedia<br>Chair<br>W51 - D55 - H81<br>Kg 4,1          |                 |      | EN581-1/ EN581-2 |
| 209<br>Poltroncina<br>Armchair<br>W56 - D55 - H81<br>Kg 4,5 |                 |      | EN581-1/ EN581-2 |
| 211<br>Sgabello<br>Barstool<br>W56 - 58 - H105<br>Kg 5,3    |                 |      |                  |

## COLORI STRUTTURA—FRAME COLORS

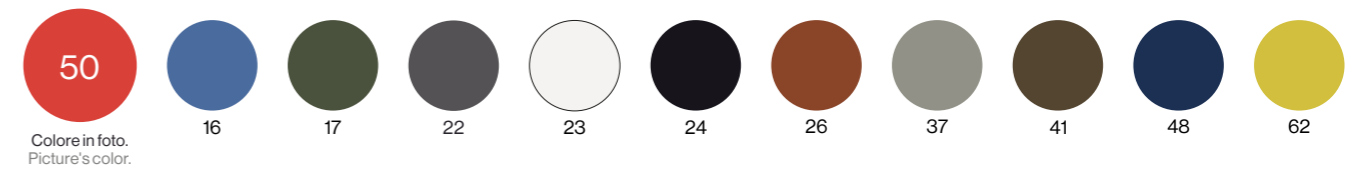

## CUSCINI—CUSHIONS

| Codice/Code<br>Tipologia/Typology  | Colori tessuto<br>Fabric colors | Categoria tessuto<br>Fabric category  |
|--|---------------------------------|---------------------------------------|
| C/703<br>Cuscino EMU acrilico quadrato<br>Acrylic EMU square cushion<br>x cod. 208, 209, 211<br>W38 - D38 - H2<br>Kg 0,13  |                                 | Tessuti Basic<br>Basic Fabrics        |
| C/716<br>Cuscino universale poliestere<br>Polyester universal cushion<br>x cod. 208, 209, 211<br>W40 - D38 - H2<br>Kg 0,19 |                                 | Cuscini Contract<br>Cushions Contract |

\* Cuscino visibile in foto—Cushion in the picture

## PLUS

- Il design minimale e l'estrema leggerezza sono i due punti di forza di questa collezione e la rendono trasversale ai più svariati contesti contract.— Minimal design and great lightness are the two most relevant differentiating points of this collection and make it suitable to a great variety of contract contexts.
- Schienale e sedile in lamiera stampata di alluminio con sagomatura della seduta per migliorare il comfort. Backrest and seat in moulded aluminium sheet. Shaped seat to improve comfort.
- Cuscino sfoderabile in tessuto acrilico C/703, fissaggio con i laccetti. C/703 cover removable cushion, in acrylic fabric, with laces fastening.
- Cuscino C/716 fissaggio con antiscivolo.— C/716 cushion with anti-slip system.





Scansiona e scopri i progetti.  
Scan and discover the projects.



500  
Sedia  
Chair



Seduta e schienale realizzati con cinghie in fibra di polipropilene e fili di gomma sintetica. Questo materiale conferisce al prodotto grande comfort e leggerezza.  
Aluminium frame with seat and backrest made with polypropylene fibers and synthetic rubber threads. This material makes the product extremely comfortable and light.

501  
Poltroncina  
Armchair

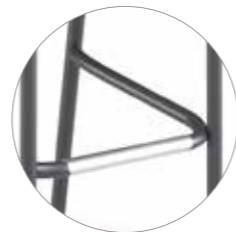

Copertura poggiatesta dello sgabello in acciaio inossidabile per protezione contro i graffi della vernice.  
The stool has a stainless steel footrest cover for protection against painting scratches.

533  
Sgabello  
Barstool



## PRODOTTI—PRODUCTS

| Codice/Code<br>Tipologia/Typology                            | Disegno/Drawing | Info | TEST             |
|--|-----------------|------|------------------|
| 500<br>Sedia<br>Chair<br>W51 - D57 - H81<br>Kg 2,6           |                 |      | EN581-1/ EN581-2 |
| 501<br>Poltroncina<br>Armchair<br>W58 - D55 - H81<br>Kg 3,2  |                 |      | EN581-1/ EN581-2 |
| 533<br>Sgabello<br>Barstool<br>W50,5 - D50,5 - H95<br>Kg 3,3 |                 |      |                  |

### COLORI STRUTTURA/SEDUTA E SCHIENALE—FRAME/SEAT AND BACKREST COLORS

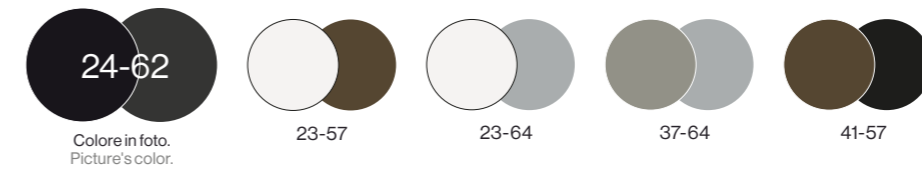



Scansiona e scopri i progetti.  
Scan and discover the projects.



**503**  
Poltrona  
Lounge chair



Sistema di fissaggio cinghie brevetto EMU - I tubolari di seduta e schienale hanno un canale interno che permette l'inserimento delle varie cinghie, il loro intreccio e il fissaggio. Tale sistema, risultato di una specifica soluzione tecnica originale EMU e brevettata, permette la sostituzione di cinghie in caso di danneggiamento.

Belt fastening system patented by EMU. The seat and back tubular have an internal channel that allows the insertion of the various belts, their interlacing and fixing. This system, the result of a specific original and patented EMU technical solution, allows the replacement of belts in case of damage.

**531**  
Divano  
Sofa



## PRODOTTI—PRODUCTS

| Codice/Code<br>Tipologia/Typology                                     | Disegno/Drawing | Info | TEST             |
|---|-----------------|------|------------------|
| <b>503</b><br>Poltrona<br>lounge chair<br>W73 - D71,5 - H77<br>Kg 3,6 |                 |      | EN581-1/ EN581-2 |
| <b>531</b><br>Divano<br>Sofa<br>W139 - D71,5 - H77<br>Kg 7,8          |                 |      |                  |

### COLORI STRUTTURA/SEDUTA E SCHIENALE—FRAME/SEAT AND BACKREST COLORS

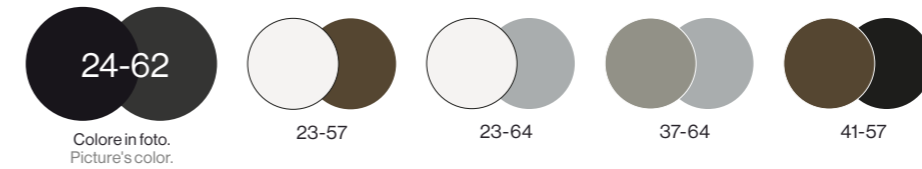

### ALTRI PRODOTTI IN COLLEZIONE—OTHER COLLECTION'S PRODUCTS



YARD  
Cod. 504  
Letino impilabile  
Stackable sunbed  
PAG. 288



YARD  
Cod. 507  
Tavolo basso  
Coffee table  
PAG. 264



YARD  
Cod. 509  
Tavolo basso  
Coffee table  
PAG. 264



MIA—LOUVRE MUSEUM BISTROT—UNITED ARAB EMIRATES



RE-TROUVÉ—TNT HOOFFDORP—HOLLAND

# EMU NEL MONDO EMU IN THE WORLD

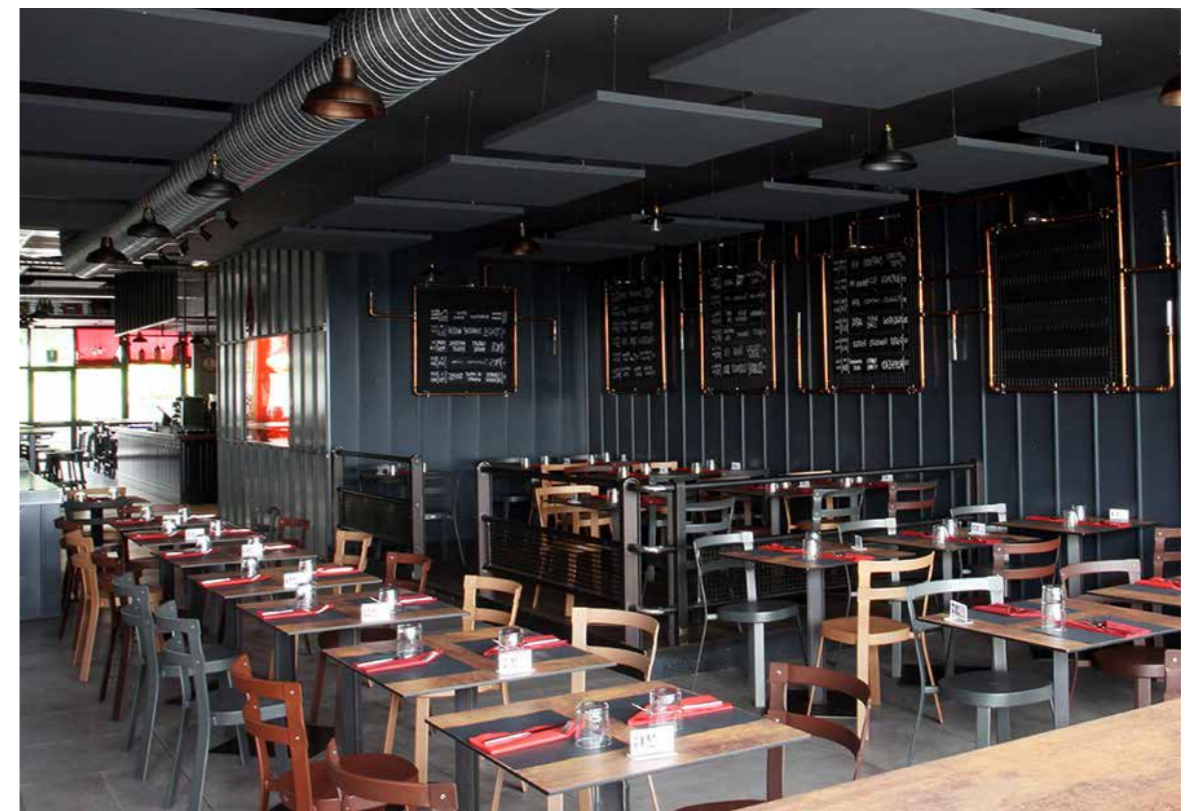

THOR—INES BEER-B-Q—ITALY



# TAVOLI A 4 GAMBE 4-LEGGED TABLES

Allungabili, impilabili, con varie altezze, colori e abbinamenti: EMU offre un'ampia scelta di tavoli a 4 gambe che soddisfano i massimi requisiti qualitativi in termini di resistenza, estetica e funzionalità. Il design trasversale di questi tavoli è studiato per creare diversi abbinamenti con le varie collezioni EMU. Inoltre, i piani sono realizzati con materiali innovativi e possono avere più dimensioni e forme, mentre le gambe, autolivellanti o con sottopiede regolabile, assicurano comfort e stabilità sulle superfici irregolari.

Extensible, stackable, with different heights, colors and combinations: EMU offers a wide range of high-quality, aesthetically pleasing and functional 4-legged tables. The lateral thinking behind the design of these tables allows them to provide a custom correspondence with various EMU collections. Furthermore, the innovative materials used for the table tops come in numerous sizes and shapes, whereas the self levelling legs or legs with adjustable feet ensure comfort and stability even on uneven surfaces.

## INDEX

|     |              |   |
|-----|--------------|---|
| 134 | ARC EN CIEL  | ● |
| 136 | CAMBI        | ● |
| 140 | NOVA         | ● |
| 144 | PIGALLE      | ● |
| 146 | STAR         | ● |
| 148 | TABLE SYSTEM | ● |
| 154 | URBAN        | ● |
| 156 | YARD         | ● |

LEGENDA—LEGEND  
● Acciaio—Steel  
● Alluminio—Aluminium  
● Legno—Wood

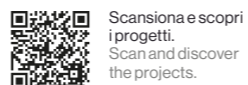

**331**  
Tavolo pieghevole 4 posti  
4 seats folding table



**334**  
Tavolo pieghevole 2 posti  
2 seats folding table



**346**  
Tavolo pieghevole 2/4 posti  
2/4 seats folding table



**364**  
Tavolo pieghevole 4/6 posti  
4/6 seats folding table



Piano in lamiera zincata piegata per garantire un bordo morbido in appoggio e smussatura degli spigoli.  
Table with bent hot-dip zincated sheet top to ensure a soft edge to the touch and chamfering of the edges.

## PRODOTTI—PRODUCTS

| Codice/Code<br>Tipologia/Typology | Disegno/Drawing | Info |
|-----------------------------------|-----------------|------|
|-----------------------------------|-----------------|------|

**331**  
Tavolo pieghevole  
4 posti  
4 seats folding table  
W110 - D70 - H74  
Kg 16,4

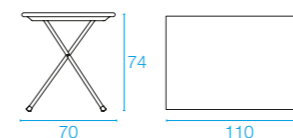

**334**  
Tavolo pieghevole  
2 posti  
2 Seats folding table  
W70 - D50 - H74  
Kg 8,1

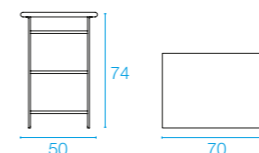

**346**  
Tavolo pieghevole  
2/4 posti  
2/4 seats folding table  
ø80 - H74  
Kg 10,1

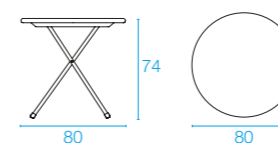

**364**  
Tavolo pieghevole  
4/6 posti  
4/6 seats folding table  
W160 - D80 - H74  
Kg 26,5

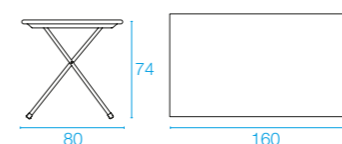

### COLORI STRUTTURA—FRAME COLORS

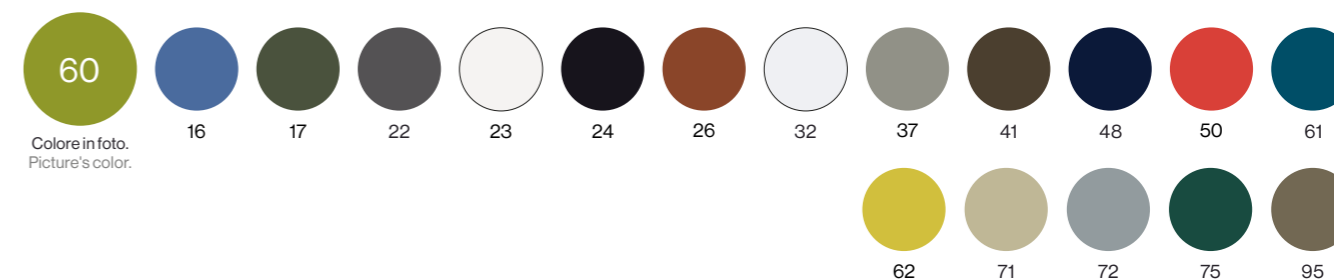

### PLUS

- Il bloccaggio delle gambe evita la chiusura accidentale e garantisce una sicura stabilità.  
Legs locking prevents accidental closure and ensures greater stability.
- Tavoli pieghevoli. Facilità rimessaggio e salvaspazio.  
Folding tables for an easy storage and space-saving.
- Le varie misure disponibili permettono di servire le differenti esigenze di spazio degli ambienti contract, sia indoor che outdoor.—The various available sizes allow to support different needs of indoor and outdoor contract contexts.



Scansiona e scopri i progetti.  
Scan and discover the projects.



**800**  
Tavolo quadrato 2 posti  
2 seats square table



**801**  
Tavolo quadrato 2/4 posti  
2/4 seats square table

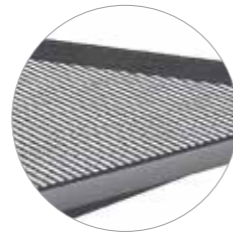

Lamiera stirata zincata a caldo.  
Hot-dip zincated sheet.

**802**  
Tavolo quadrato 4 posti  
4 seats square table

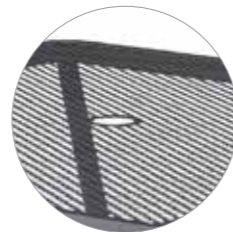

Foro centrale per palo ombrellone (escluso cod. 800).  
Table top with central hole for the insertion of the sunshade pole (not included cod. 800).

**803**  
Tavolo tondo 4 posti  
4 seats round table



## PRODOTTI—PRODUCTS

| Codice/Code<br>Tipologia/Typology   | Disegno/Drawing | Info |
|---|-----------------|------|
| <b>800</b><br>Tavolo quadrato 2 posti<br>2 seats square table<br>W60 - D60 - H75<br>Kg 11,2     |                 |      |
| <b>801</b><br>Tavolo quadrato 2/4 posti<br>2/4 seats square table<br>W80 - D80 - H75<br>Kg 14,9 |                 |      |
| <b>802</b><br>Tavolo quadrato 4 posti<br>4 seats square table<br>W90 - D90 - H75<br>Kg 16,8     |                 |      |
| <b>803</b><br>Tavolo tondo 4 posti<br>4 seats round table<br>ø80 - H75<br>Kg 12,0               |                 |      |

### COLORI STRUTTURA—FRAME COLORS

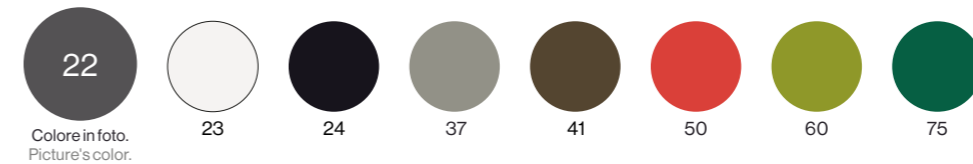

### PLUS

• Il design intramontabile di questa linea di tavoli li rende particolarmente adatti ad ambienti contract dallo stile classico, sia indoor che outdoor.—The timeless design of this tables collection make them suitable to classic indoor and outdoor contract contexts.  
• Le varie misure disponibili permettono di servire le differenti esigenze di spazio.  
The various available sizes allow to support different space needs.



Scansiona e scopri i progetti.  
Scan and discover the projects.

**804**  
Tavolo tondo 5 posti  
5 seats round table



**805**  
Tavolo tondo 6 posti  
6 seats round table



**807**  
Tavolo rettangolare 4/6 posti  
4/6 seats rectangular table



**808**  
Tavolo rettangolare 6 posti  
6 seats rectangular table



Sottopiede regolabile per una migliore stabilità su superfici irregolari.  
Adjustable feet for better stability on uneven surfaces.

## PRODOTTI—PRODUCTS



| Codice/Code<br>Tipologia/Typology  | Disegno/Drawing | Info |
|--|-----------------|------|
| <b>804</b><br>Tavolo tondo 5 posti<br>5 seats round table<br>ø106 - H75<br>Kg 16,2                           |                 |      |
| <b>805</b><br>Tavolo tondo 6 posti<br>6 seats round table<br>ø120 - H75<br>Kg 19,0                           |                 |      |
| <b>807</b><br>Tavolo rettangolare<br>4/6 posti<br>4/6 seats rectangular table<br>W120 - D80 - H75<br>Kg 18,3 |                 |      |
| <b>808</b><br>Tavolo rettangolare<br>6 posti<br>6 seats rectangular table<br>W140 - D80 - H75<br>Kg 20,5     |                 |      |

### COLORI STRUTTURA—FRAME COLORS

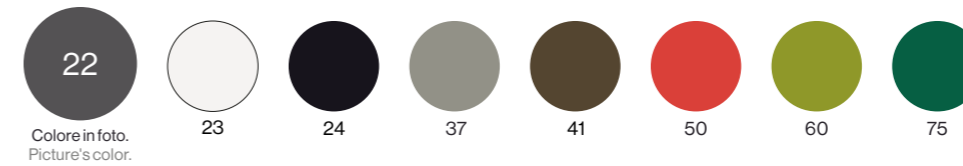



Scansiona e scopri i progetti.  
Scan and discover the projects.



**857**  
Tavolo quadrato impilabile 2/4 posti  
2/4 seats stackable square table



**858**  
Tavolo quadrato impilabile 2 posti  
2 seats stackable square table



**859**  
Tavolo quadrato impilabile 4 posti  
4 seats stackable square table



**854**  
Tavolo rettangolare impilabile  
4/6 posti  
4/6 seats stackable rectangular table



Gambe smontabili e imballo salvaspazio per i cod. 859, 854 e per i tavoli alti.  
The products cod. 859, 854 and the counter tables have removable legs and space-saving packaging.

## PRODOTTI—PRODUCTS

| Codice/Code<br>Tipologia/Typology  | Disegno/Drawing | Info | TEST            |
|--|-----------------|------|-----------------|
| <b>857</b><br>Tavolo quadrato impilabile 2/4 posti<br>2/4 Seats stackable square table<br>W80 - D80 - H74<br>Kg 14,0           |                 |      | EN581-1/EN581-3 |
| <b>858</b><br>Tavolo quadrato impilabile 2 posti<br>2 seats stackable square table<br>W70 - D70 - H74<br>Kg 11,8               |                 |      | EN581-1/EN581-3 |
| <b>859</b><br>Tavolo quadrato impilabile 4 posti<br>4 seats stackable square table<br>W90 - D90 - H74<br>Kg 18,9               |                 |      |                 |
| <b>854</b><br>Tavolo rettangolare impilabile 4/6 posti<br>4/6 seats stackable rectangular table<br>W120 - D80 - H74<br>Kg 24,0 |                 |      |                 |

### COLORI STRUTTURA—FRAME COLORS

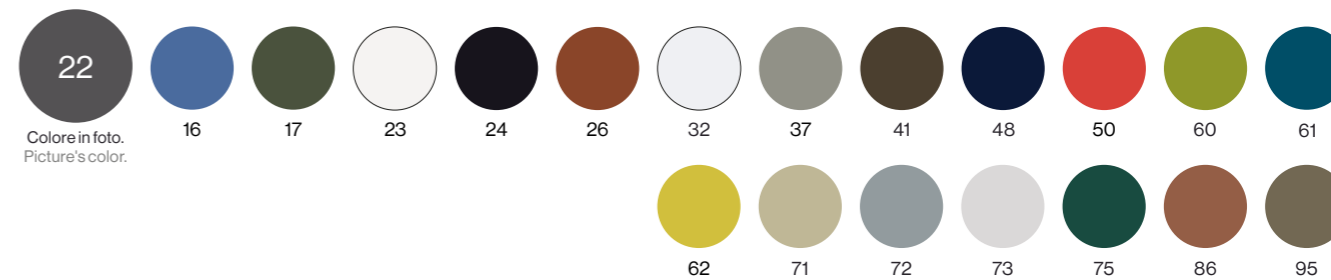

### PLUS

- I tavoli dining hanno un piano autolivellante che garantisce grande stabilità anche sulle superfici più irregolari.—Self-levelling dining tables that guarantee great stability even on the most uneven surfaces.
- I tavoli alti da aperitivo sono dotati di piedini regolabili.  
The counter tables have 4 adjustable feet.
- Piani in lamiera zincata a caldo.—Hot-dip zincated steel sheets.
- Imballati singolarmente x cod. 859, 854, 890, 891, 892, 893, 894. Imballo salvaspazio grazie alle gambe smontabili.  
Single item for pack x cod. 859, 854, 890, 891, 892, 893, 894. Flat pack due to legs to assemble.
- Ampia offerta di misure per renderli idonei a tutti gli spazi.  
Tables available in different sizes to make them suitable for all spaces.





**890**  
Tavolo alto quadrato 2 posti  
2 seats counter square table



**891**  
Tavolo alto quadrato 2/4 posti  
2/4 seats counter square table



**892**  
Tavolo alto quadrato 4 posti  
4 seats counter square table



**893**  
Tavolo alto rettangolare 4 posti  
4 seats counter rectangular table



**894**  
Tavolo alto rettangolare 4/6 posti  
4/6 seats counter rectangular table



## PRODOTTI—PRODUCTS

| Codice/Code<br>Tipologia/Typology  | Disegno/Drawing | Info |
|--|-----------------|------|
| <b>890</b><br>Tavolo alto quadrato 2 posti<br>2 seats counter square table<br>W70 - D70 - H105 Kg 18,0               |                 |      |
| <b>891</b><br>Tavolo alto quadrato 2/4 posti<br>2/4 seats counter square table<br>W80 - D80 - H105 Kg 20,0           |                 |      |
| <b>892</b><br>Tavolo alto quadrato 4 posti<br>4 seats counter square table<br>W90 - D90 - H105 Kg 22,0               |                 |      |
| <b>893</b><br>Tavolo alto rettangolare 4 posti<br>4 seats counter rectangular table<br>W120 - D70 - H105 Kg 22,5     |                 |      |
| <b>894</b><br>Tavolo alto rettangolare 4/6 posti<br>4/6 seats counter rectangular table<br>W120 - D80 - H105 Kg 23,8 |                 |      |

### COLORI STRUTTURA—FRAME COLORS

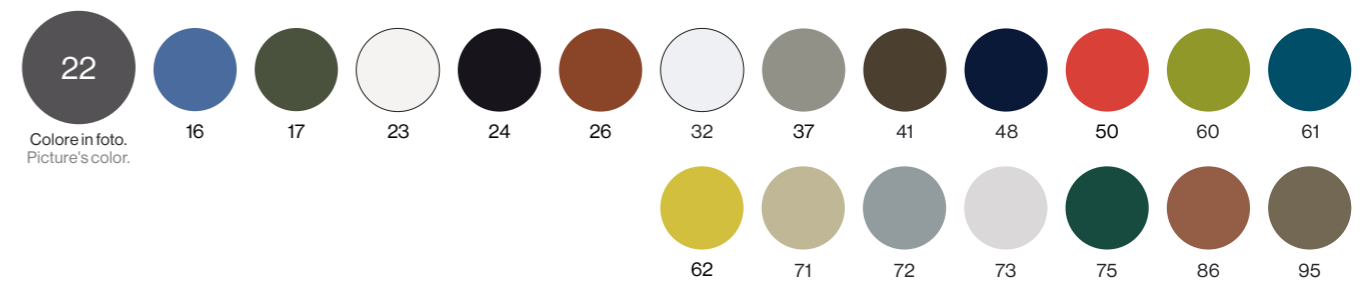



Scansiona e scopri i progetti.  
Scan and discover the projects.



**905**  
Tavolo tondo 2 posti  
2 seats round table



**906**  
Tavolo tondo 2/4 posti  
2/4 seats round table



**907**  
Tavolo pieghevole 2/4 posti  
2/4 seats folding table

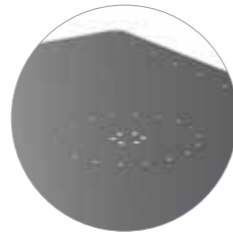

Fori decorativi per scolo acqua piovana.  
Decorative holes for rainwater drainage.

**904**  
Tavolo pieghevole 5 posti  
5 seats folding table



Gli archi conferiscono grazia alla struttura delle gambe garantendo un maggior comfort agli utenti.  
The curvatures give grace to the legs frame ensuring greater comfort to the users.

**903**  
Tavolo pieghevole  
4/6 posti  
4/6 seats folding table



## PRODOTTI—PRODUCTS

| Codice/Code<br>Tipologia/Typology   | Disegno/Drawing | Info |
|---|-----------------|------|
| <b>905</b><br>Tavolo tondo 2 posti<br>2 seats round table<br>ø60 - H72 Kg 6,4                       |                 |      |
| <b>906</b><br>Tavolo tondo 2/4 posti<br>2/4 seats round table<br>ø80 - H72 Kg 9,6                   |                 |      |
| <b>907</b><br>Tavolo pieghevole<br>2/4 posti<br>2/4 seats folding table<br>W76 - D76 - H74 Kg 12,2  |                 |      |
| <b>904</b><br>Tavolo pieghevole<br>5 posti<br>5 seats folding table<br>ø105 - H74 Kg 16,3           |                 |      |
| <b>903</b><br>Tavolo pieghevole<br>4/6 posti<br>4/6 seats folding table<br>W118 - D76 - H74 Kg 16,5 |                 |      |

## COLORI STRUTTURA—FRAME COLORS

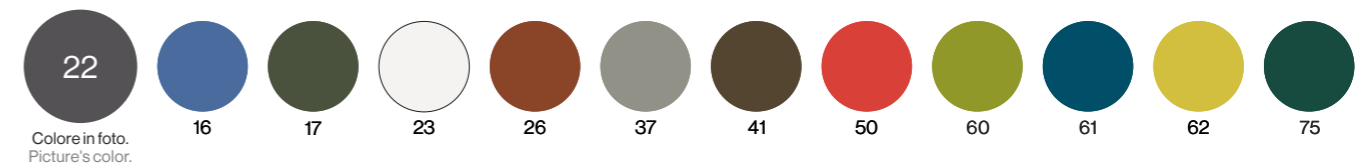

## PLUS

- Tavolo pieghevole (x cod. 907, 904, 903): facilità rimessaggio e salvaspazio.  
Folding table (x cod. 907, 904, 903) for an easy storage and space-saving.
- Il bloccaggio delle gambe evita la chiusura accidentale e garantisce una sicura stabilità.  
Legs locking prevents accidental closure and ensures greater stability.
- Design evergreen particolarmente adatto ad ambienti contract dallo stile classico, sia indoor che outdoor.  
Evergreen design suitable to classic indoor and outdoor contract contexts.



Scansiona e scopri i progetti.  
Scan and discover the projects.



**305**  
Tavolo quadrato 2 posti  
2 seats square table



**306**  
Tavolo quadrato 4 posti  
4 seats square table



La forma simil-ellittica del tubo delle gambe e l'orientamento a 45° circa rispetto ai due lati del piano conferisce particolare solidità al tavolo.  
The elliptical shape of the leg pipe and the orientation at about 45° with respect to the two sides of the table top give particular solidity to the table.

**307**  
Tavolo rettangolare 6 posti  
6 seats rectangular table



## PRODOTTI—PRODUCTS

| Codice/Code<br>Tipologia/Typology  | Disegno/Drawing | Info |
|--|-----------------|------|
| <b>305</b><br>Tavolo quadrato 2 posti<br>2 seats square table<br>W70 - D70 - H75<br>Kg 17,5              |                 |      |
| <b>306</b><br>Tavolo quadrato 4 posti<br>4 seats square table<br>W90 - D90 - H75<br>Kg 23,0              |                 |      |
| <b>307</b><br>Tavolo rettangolare<br>6 posti<br>6 seats rectangular table<br>W160 - D90 - H75<br>Kg 34,5 |                 |      |

### COLORI STRUTTURA—FRAME COLORS

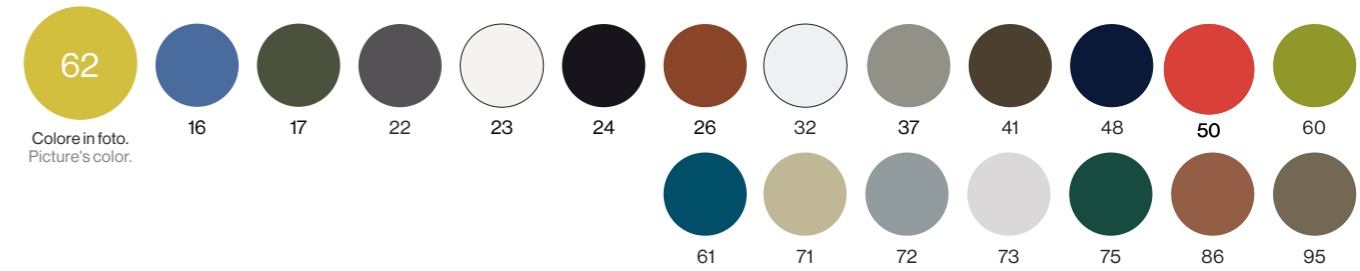

### PLUS

- Piano in lamiera zincata a caldo.— Tables with hot-dip zincated sheet top.
- Gambe smontabili. Imballo salvaspazio.— Removable legs. Flat pack.
- Cod. 306 e 307 possono essere accostati per aumentare i posti tavola.  
Cod. 306 and 307 could be placed side by side to increase the number of available seats.

# TABLE SYSTEM

Design by EMU



Scansiona e scopri i progetti.  
Scan and discover the projects.



1133

Tavolo abbattibile bordo basso 4/6 posti  
4/6 seats low border collapsible table



17

Colore in foto.  
Picture's color.

1134

Tavolo abbattibile bordo basso 6 posti  
6 seats low border collapsible table



17

Colore in foto.  
Picture's color.

1163

Tavolo bordo basso 4/6 posti  
4/6 seats low border table



24

Colore in foto.  
Picture's color.

1165

Tavolo bordo basso 6 posti  
6 seats low border table



24

Colore in foto.  
Picture's color.

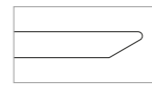

Piano bordo basso—Low border top

## PRODOTTI—PRODUCTS

| Codice/Code<br>Tipologia/Typology   | Disegno/Drawing | Info |
|---|-----------------|------|
| 1133<br>Tavolo abbattibile bordo basso 4/6 posti<br>4/6 seats low border collapsible table<br>W120 - D80 - H75<br>Kg 24,1 |                 |      |
| 1134<br>Tavolo abbattibile bordo basso 6 posti<br>6 seats low border collapsible table<br>W140 - D80 - H75<br>Kg 26,1     |                 |      |
| 1163<br>Tavolo bordo basso 4/6 posti<br>4/6 seats low border table<br>W120 - D80 - H74<br>Kg 24,8                         |                 |      |
| 1165<br>Tavolo bordo basso 6 posti<br>6 seats low border table<br>W140 - D80 - H74<br>Kg 26,9                             |                 |      |

### COLORI STRUTTURA—FRAME COLORS

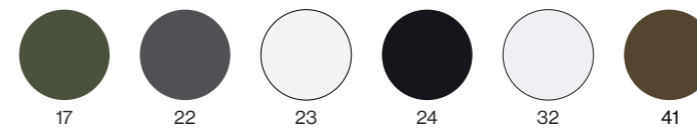

## PLUS

- Struttura in acciaio zincato dentro e fuori.— Inside and out frame in hot-dip zincated steel.
- N.4 sottopiedi regolabili.— N.4 adjustable feet.
- Disponibili con piani abbattibili e piani fissi.— Available with collapsible and fixed tops.
- Piani abbattibili x cod. 1133, 1134, 1139, 1141.— Collapsible tops x cod. 1133, 1134, 1139, 1141.
- Tavoli con piano abbattibile - possibilità di scegliere due diverse tipologie di bordi dei piani: bordo basso e bordo squadrato a seconda dello stile della seduta in abbinamento.— Collapsible tables - you can choose two different types of tops: low border and square border according to the style of the matching seat.
- Piani fissi x cod. 1163, 1165, 1172, 1174, 1157.— Fixed tops x cod. 1163, 1165, 1172, 1174, 1157.
- Tavoli con piano fisso - possibilità di scegliere tre diverse tipologie di bordi dei piani: bordo basso, bordo squadrato e bordo tondo a seconda dello stile della seduta in abbinamento.— Fixed tables - you can choose three different types of border tops: low border, square border and round border according to the style of the matching seat.
- Ampia gamma di dimensione piani.— Table tops available in different sizes.
- Possibile applicazione di piani speciali — Possibility to apply special tops.

# TABLE SYSTEM

Design by EMU



Scansiona e scopri i progetti.  
Scan and discover the projects.



1139

Tavolo abbattibile bordo squadrato 4/6 posti  
4/6 seats square border collapsible table



22

Colore in foto.  
Picture's color.

1141

Tavolo abbattibile bordo squadrato 6 posti  
6 seats square border collapsible table



22

Colore in foto.  
Picture's color.

1172

Tavolo bordo squadrato 4/6 posti  
4/6 seats square border table



41

Colore in foto.  
Picture's color.

1174

Tavolo bordo squadrato 6 posti  
6 seats square border table



41

Colore in foto.  
Picture's color.

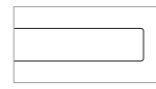

Piano bordo squadrato—Square border top

## PRODOTTI—PRODUCTS

| Codice/Code<br>Tipologia/Typology  | Disegno/Drawing | Info |
|--|-----------------|------|
| 1139<br>Tavolo abbattibile bordo squadrato 4/6 posti<br>4/6 seats square border collapsible table<br>W120 - D80 - H75<br>Kg 23,8 |                 |      |
| 1141<br>Tavolo abbattibile bordo squadrato 6 posti<br>6 seats square border collapsible table<br>W140 - D80 - H75<br>Kg 25,4     |                 |      |
| 1172<br>Tavolo bordo squadrato 4/6 posti<br>4/6 seats square border table<br>W120 - D80 - H75<br>Kg 25,5                         |                 |      |
| 1174<br>Tavolo bordo squadrato 6 posti<br>6 seats square border table<br>W140 - D80 - H75<br>Kg 26,7                             |                 |      |

### COLORI STRUTTURA—FRAME COLORS

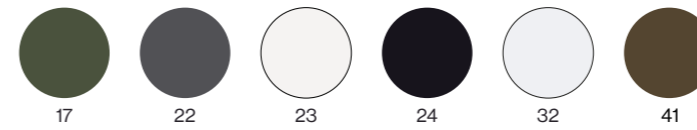

# TABLE SYSTEM

Design by EMU



Scansiona e scopri i progetti.  
Scan and discover the projects.

1157

Tavolo bordo tondo 4/6 posti  
4/6 seats round border table



Colore in foto.  
Picture's color.

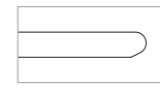

Piano bordo tondo—Round border top



## PRODOTTI—PRODUCTS

| Codice/Code<br>Tipologia/Typology | Disegno/Drawing | Info |
|-----------------------------------|-----------------|------|
|-----------------------------------|-----------------|------|

1157

Tavolo bordo  
tondo 4/6 posti  
4/6 seats round border table  
W120 - D76 - H74  
Kg 21,6

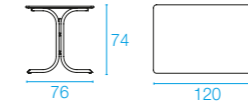

### COLORI STRUTTURA—FRAME COLORS

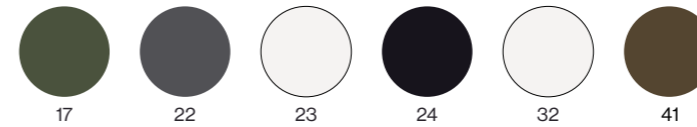



Scansiona e scopri i progetti.  
Scan and discover the projects.

**096**  
Tavolo impilabile 2/4 posti  
2/4 seats stackable table



**090**  
Tavolo impilabile 4 posti  
4 seats stackable table



**091**  
Tavolo impilabile 4/6 posti  
4/6 seats stackable table

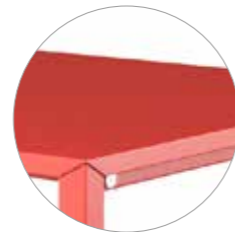

Piano in lamiera piena preferito nell'utilizzo contract perché protegge le gambe in caso di caduta di liquidi sulla sua superficie.  
Solid sheet metal top preferred in contract use because it protects the legs in case liquids fall on its surface.

## PRODOTTI—PRODUCTS



| Codice/Code<br>Tipologia/Typology   | Disegno/Drawing | Info | TEST            |
|---|-----------------|------|-----------------|
| <b>096</b><br>Tavolo impilabile 2/4 posti<br>2 seats stackable table<br>W80 - D80 - H75<br>Kg 8,5     |                 |      | EN581-1/EN581-3 |
| <b>090</b><br>Tavolo impilabile 4 posti<br>4 seats stackable table<br>W90 - D90 - H75<br>Kg 9,8       |                 |      |                 |
| <b>091</b><br>Tavolo impilabile 4/6 posti<br>4/6 seats stackable table<br>W120 - D80 - H75<br>Kg 11,8 |                 |      |                 |

### COLORI STRUTTURA—FRAME COLORS

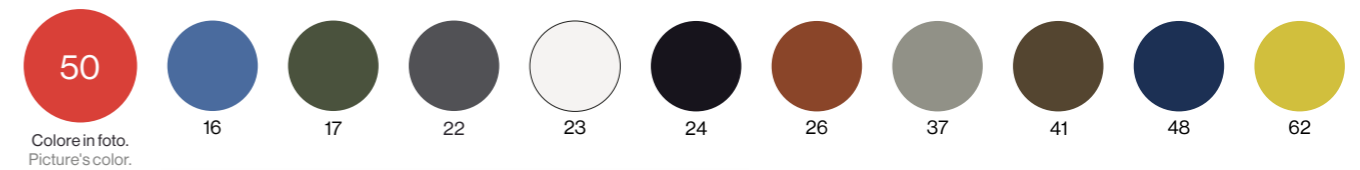

Impilabile.  
Stackable.

### PLUS

- Modello a 4 gambe dal design lineare, che può essere accompagnato a tutte le collezioni.  
4-legged model with a linear design, which can be combined with all collections.
- Quattro piedi regolabili per garantire stabilità ed un perfetto allineamento dei piani se si accoppiano i tavoli.— 4 adjustable feet to ensure greater stability and perfect alignment if you decide to align them closer.
- Autolivellante su pavimenti irregolari e dotato di piedini regolabili per compensare anche i dislivelli maggiori.  
Self-leveling tables and equipped with adjustable feet to compensate greater height differences.
- Facile da montare. Imballo salvaspazio.— Easy to assemble. Flat pack.
- Leggerezza (piano e struttura in alluminio).— Lightness (aluminium top and frame).
- Tavoli disponibili in diverse misure, idonei a tutti gli spazi.  
Tables available in different sizes to make them suitable for all spaces.
- Smontabile per ridurre il volume di imballo e facilitare stoccaggio e spedizione.  
Removable legs to reduce the volume of packaging and facilitate the storage.
- Imballati singolarmente.— One piece for pack.



Scansiona e scopri i progetti.  
Scan and discover the projects.

**538**  
Tavolo alto 6/8 posti  
6/8 seats counter table



## PRODOTTI—PRODUCTS



| Codice/Code<br>Tipologia/Typology | Disegno/Drawing | Info | TEST |
|-----------------------------------|-----------------|------|------|
|-----------------------------------|-----------------|------|------|

**538**

Tavolo alto 6/8 posti  
6/8 seats counter table  
W180 - D70 - H105  
Kg 24,0

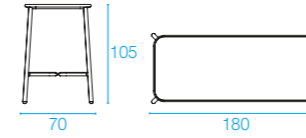

EN581-1/ EN581-3

### COLORI STRUTTURA—FRAME COLORS

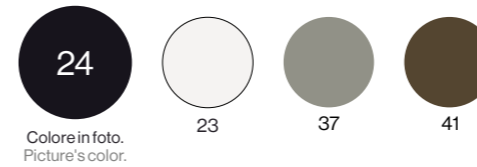

Colore in foto.  
Picture's color.

### PLUS

- Tavolo capace di ospitare 6-8 posti.—Large counter table up to 6/8 seating.
- La struttura in alluminio leggera e slanciata offre altresì grande stabilità.  
Light and slender aluminum frame offers great stability.
- Protezione traversa poggia piedi in nylon.—Nylon feet crossbar cover.



# EMU NEL MONDO EMU IN THE WORLD

ROUND—TRULLO ERMES & ATENA—ITALY



RIO R50+NOVA—MAXXI MUSEUM—ITALY



HEAVEN+RE-TROUVÉ—ANEMOS LUXURY GRAND RESORT—GREECE



# TAVOLI A PALO CENTRALE CENTRAL POLE TABLES

Disponibili in diverse dimensioni, materiali e colori, i tavoli con struttura a palo centrale conferiscono all'ambiente un'estetica pulita ed elegante. Per una soluzione salvaspazio, questa tipologia di tavolo può prevedere piani abbattibili. I pali centrali, con sezioni quadrate e rotonde, vengono abbinati con basamenti anch'essi disponibili in più forme e completati con un'ampia scelta di piani.

Available in various sizes, materials and colors, our tables with a central pole frame ensure the space a feeling of elegance and clean lines. This type of table has also space-saving solutions with folding tops. The central pole with square and round sections is matched with round, square and cross-shaped bases, completed with a broad selection of table tops.

## INDEX

LEGENDA—LEGEND  
● Acciaio—Steel  
● Alluminio—Aluminium  
● Legno—Wood

|     |              |   |
|-----|--------------|---|
| 162 | COMO         | ● |
| 164 | DARWIN       | ● |
| 168 | GRACE        | ● |
| 170 | HEAVEN       | ● |
| 172 | HPL TOPS     | ● |
| 178 | RE-TROUVÉ    | ● |
| 180 | ROUND        | ● |
| 184 | SHINE        | ● |
| 186 | TABLE SYSTEM | ● |
| 200 | TERRAMARE    | ● |
| 202 | THOR         | ● |



Scansiona e scopri  
i progetti.  
Scan and discover  
the projects.

494+1207  
Tavolo tondo 6/7 posti  
6/7 seats round table

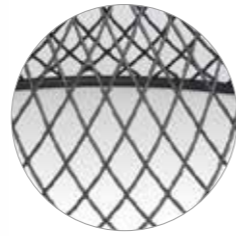

Il sinuoso reticolo di tondini zincati della base del tavolo evoca forme classiche e definisce il design esclusivo del prodotto. La struttura in tondini è realizzata tramite saldatura a proiezione. The sinuous grid of zincated bars of the table base reminds classic shaped and defines the exclusive design of the collection. The bars frame is manufactured by spot welding.



Piano in lamiera zincata di ampie dimensioni capace di ospitare 7 posti tavola. Large table top in hot-dip zincated sheet capable of 7 seating.

## PRODOTTI—PRODUCTS



| Codice/Code<br>Tipologia/Typology | Disegno/Drawing | Info |
|-----------------------------------|-----------------|------|
|-----------------------------------|-----------------|------|

494

Struttura tavolo tondo  
Round table frame  
ø110 - H74  
Kg 13,2

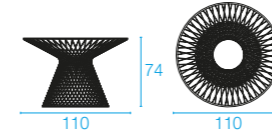

1207

Piano tavolo tondo  
6/7 posti  
6/7 seats round  
table top  
ø144 - H2  
Kg 26,6

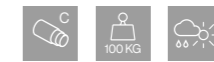

### COLORI STRUTTURA—FRAME COLORS

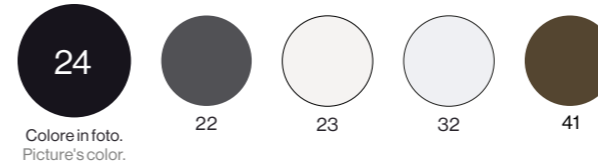

Colore in foto.  
Picture's color.



Scansiona e scopri i progetti.  
Scan and discover the projects.

525

Tavolo abbattibile 2 posti  
2 seats collapsible table



528

Tavolo alto abbattibile 2 posti  
2 seats collapsible high table



529

Tavolo abbattibile 2/4 posti  
2/4 seats collapsible table



## PRODOTTI—PRODUCTS



| Codice/Code<br>Tipologia/Typology  | Disegno/Drawing | Info | TEST              |
|--|-----------------|------|-------------------|
| 525<br>Tavolo abbattibile<br>2 posti<br>2 seats collapsible table<br>W70 - D70 - H74<br>Kg 14,3            |                 |      | EN581-1 / EN581-3 |
| 528<br>Tavolo alto abbattibile<br>2 posti<br>2 seats collapsible high table<br>W70 - D70 - H105<br>Kg 15,2 |                 |      | EN581-1 / EN581-3 |
| 529<br>Tavolo abbattibile<br>2/4 posti<br>2/4 seats collapsible table<br>W80 - D80 - H74<br>Kg 16,0        |                 |      | EN581-1 / EN581-3 |

### COLORI STRUTTURA—FRAME COLORS

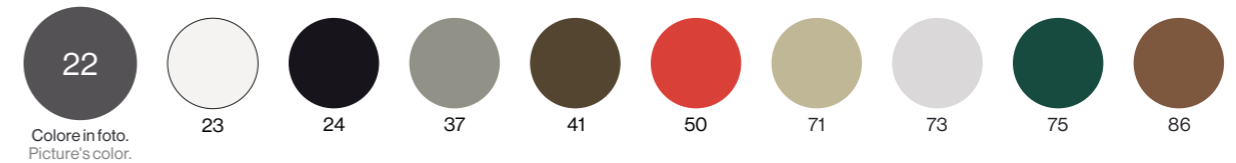

### PLUS

- Varie dimensioni disponibili.— Available in different sizes.
- Piano abbattibile, per una soluzione salvaspazio, tramite snodo in pressofusione di alluminio.  
Folding tops for a space-saving solution, by means of a die-cast aluminium joint.
- Sottopiede regolabile per una migliore stabilità su superfici irregolari.  
Adjustable feet for better stability on uneven surfaces.
- Struttura cod. 564: possibili personalizzazioni con piani HPL.  
Frame code 564: possible customizations with HPL table tops.



Scansiona e scopri i progetti.  
Scan and discover the projects.

**848**  
Tavolo abbattibile 2 posti  
2 seats collapsible table



**849**  
Tavolo abbattibile 2/4 posti  
2/4 seats collapsible table



## PRODOTTI—PRODUCTS

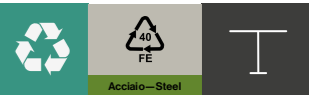

| Codice/Code<br>Tipologia/Typology | Disegno/Drawing | Info |
|-----------------------------------|-----------------|------|
|-----------------------------------|-----------------|------|

**848**  
Tavolo abbattibile  
2 posti  
2 seats collapsible table  
ø60 - H74  
Kg 11,9

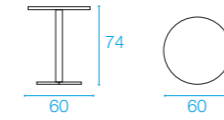

**849**  
Tavolo abbattibile  
2/4 posti  
2/4 seats collapsible table  
ø80 - H74  
Kg 14,8

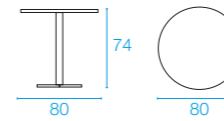

**564**  
Struttura tavolo  
per piani HPL  
Table frame for HPL tops  
x cod. 977, 978  
W51 - D51 - H73  
Kg 7,3

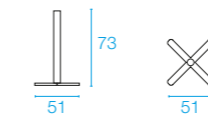

### COLORI STRUTTURA—FRAME COLORS

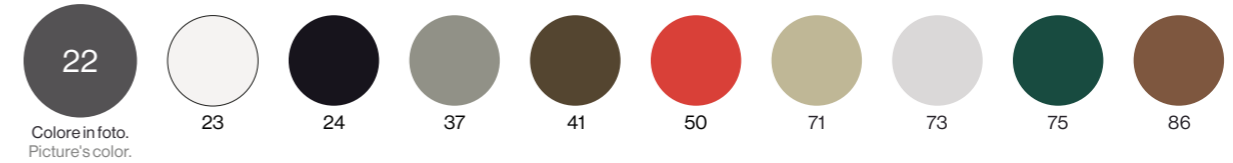



**285+288**  
Tavolo abbattibile bordo quadro 2 posti  
2 seats collapsible square border table



**285+286**  
Tavolo abbattibile bordo quadro 2/4 posti  
2/4 seats collapsible square border table



**285+544**  
Tavolo abbattibile bordo tondo 2 posti  
2 seats collapsible round border table



**285+547**  
Tavolo abbattibile bordo tondo 2/4 posti  
2/4 seats collapsible round border table



Elegante struttura a palo centrale dalle forme slanciate. Gambe realizzate in tubolare di alluminio e giunto in pressofusione che conferisce un'estetica pulita e curata.  
Central pole table with slender shapes. Legs made of aluminium tubular and die-cast joint that gives a clean and refined aesthetic.



N.4 sottopiedi regolabili che permettono di livellare il tavolo e garantire stabilità anche su superfici irregolari.  
N. 4 adjustable feet that allow the table to be levelled and ensure its stability even on uneven floors.

## PRODOTTI—PRODUCTS



| Codice/Code<br>Tipologia/Typology | Disegno/Drawing | Info | TEST |
|-----------------------------------|-----------------|------|------|
|-----------------------------------|-----------------|------|------|

|   |  |  |  |
|---|--|--|--|
| <b>285</b><br>Struttura tavolo abbattibile<br>Collapsible table frame<br>x cod. 286, 288, 544, 547<br>W52 - D52 - H70<br>Kg 3,3 |  |  | EN581-1/EN581-3<br>(cod. 285+288, 285+286) |
|---|--|--|--|

|  |  |  |                                   |
|--|--|--|-----------------------------------|
| <b>288</b><br>Piano bordo quadro per tavolo abbattibile 2 posti<br>2 seats collapsible square border table top<br>W70 - D70 - H3,5<br>Kg 8,6 |  |  | EN581-1/EN581-3<br>(cod. 285+288) |
|--|--|--|-----------------------------------|

|  |  |  |                                   |
|--|--|--|-----------------------------------|
| <b>286</b><br>Piano bordo quadro per tavolo abbattibile 2/4 posti<br>2/4 seats collapsible square border table top<br>W80 - D80 - H3,5<br>Kg 9,2 |  |  | EN581-1/EN581-3<br>(cod. 285+286) |
|--|--|--|-----------------------------------|

|  |  |  |  |
|--|--|--|--|
| <b>544</b><br>Piano bordo tondo per tavolo abbattibile 2 posti<br>2 seats collapsible round border table top<br>W70 - D70 - H2,5<br>Kg 7,0 |  |  |  |
|--|--|--|--|

|  |  |  |  |
|--|--|--|--|
| <b>547</b><br>Piano bordo tondo per tavolo abbattibile 2/4 posti<br>2/4 seats collapsible round border table top<br>W80 - D80 - H2,5<br>Kg 7,6 |  |  |  |
|--|--|--|--|

### COLORI STRUTTURA—FRAME COLORS

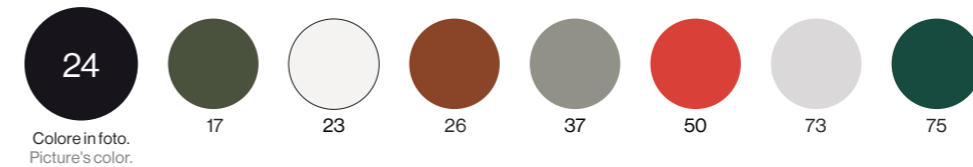

### PLUS

- Meccanismo piano reclinabile.—Reclining top.
- Viteria in inox per ridurre il rischio di corrosione, ruggine e deterioramento da agenti atmosferici.  
Stainless steel screws to reduce the risk of corrosion, rust and deterioration due to weather conditions.
- Chiusura salvaspazio - in fase di rimessaggio abbattere il piano e incrociare le varie basi per avere un "impilamento verticale" salvaspazio.  
Vertical space-saving stacking - during storage, fold the table top and cross the various bases.
- Possibilità di combinare due diverse tipologie di piani, uno con bordo squadrato e una con bordo arrotondato da scegliere a seconda dello stile della seduta in abbinamento.—It is possible to combine two different types of tops, one with a square border and one with a round border to be chosen according to the style of the matching seat.
- Leggerezza (piano e struttura in alluminio).—Great lightness of the product thanks to the aluminium top and frame.



Scansiona e scopri i progetti.  
Scan and discover the projects.

**493+493/V**  
Tavolo tondo 2/4 posti  
2/4 seats round table



**494+494/V**  
Tavolo tondo 4/6 posti  
4/6 seats round table



Piano in cristallo temperato, sicuro in uso, capace di ospitare 6 posti tavola.  
Safe in use tempered glass table top, up to 6 seats.

## PRODOTTI—PRODUCTS

| Codice/Code<br>Tipologia/Typology | Disegno/Drawing | Info |
|-----------------------------------|-----------------|------|
|-----------------------------------|-----------------|------|

### 493

Struttura tavolo tondo  
Round table frame  
x cod. 493/V  
ø70 - H74  
Kg 8,7



### 494

Struttura tavolo tondo  
Round table frame  
x cod. 494/V  
ø110 - H74  
Kg 13,2

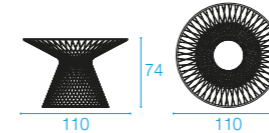

### COLORI STRUTTURA—FRAME COLORS

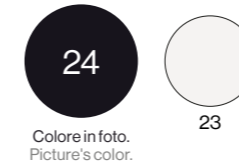

Colore in foto.  
Picture's color.

## PIANI IN CRISTALLO—GLASS TOPS

| Codice/Code<br>Tipologia/Typology  | Colori<br>Colors |
|--|------------------|
| <b>493/V</b><br>Piano in cristallo per tavolo 2/4 posti<br>Glass top for 2/4 seats table<br>x cod. 493<br>ø80 - H0,6<br>Kg 7,5   | 00<br>83         |
| <b>494/V</b><br>Piano in cristallo per tavolo 4/6 posti<br>Glass top for 4/6 seats table<br>x cod. 494<br>ø120 - H0,8<br>Kg 22,5 | 00<br>83         |

# HPL TOPS

Design by EMU



Scansiona e scopri i progetti.  
Scan and discover the projects.

**464+977**

Tavolo 2 posti con piano in HPL  
2 seats table with HPL top



**564+977**

Tavolo 2 posti con piano in HPL  
2 seats table with HPL top



**1115+977**

Tavolo 2 posti con piano in HPL  
2 seats table with HPL top



# PRODOTTI—PRODUCTS

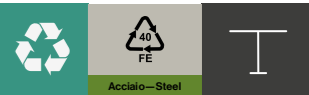

| Codice/Code<br>Tipologia/Typology | Disegno/Drawing | Info |
|-----------------------------------|-----------------|------|
|-----------------------------------|-----------------|------|

**464**

Struttura tavolo per piani HPL  
Table frame for HPL tops  
x cod. 977  
W45 - D45 - H73 Kg 14,0

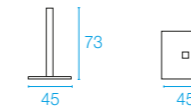

**564**

Struttura tavolo per piani HPL  
Table frame for HPL tops  
x cod. 977  
W51 - D51 - H73 Kg 7,3

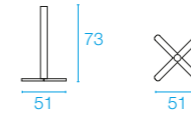

**1115**

Struttura tavolo piccola per piani HPL  
Small table frame for HPL tops  
x cod. 977  
W53 - D53 - H73 Kg 9,5

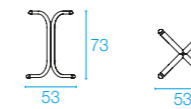

**977**

Piano in HPL per tavolo 2 posti  
HPL top for 2 seats table  
x cod. 464, 564, 1115  
W69 - D69 - H1 Kg 8,3

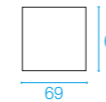

## COLORI STRUTTURA COD. 464—FRAME COLORS COD. 464

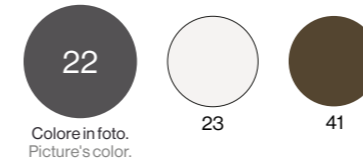

## COLORI STRUTTURA COD. 564—FRAME COLORS COD. 564

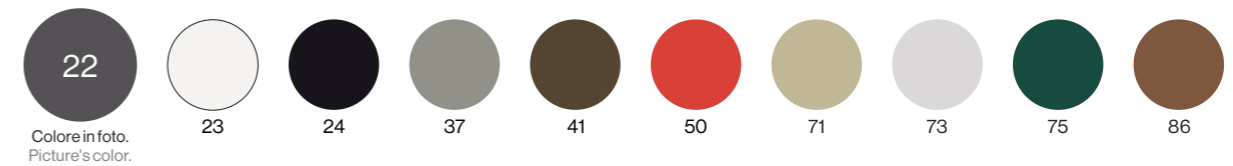

## COLORI STRUTTURA COD. 1115—FRAME COLORS COD. 1115

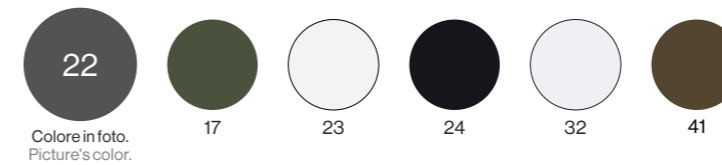

## COLORI PIANI HPL COD. 977—HPL TOPS COLORS COD. 977

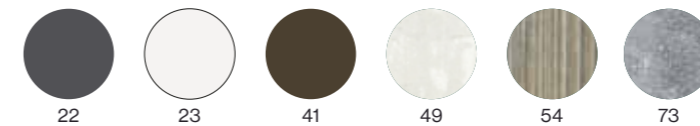



# HPL TOPS

Design by EMU



Scansiona e scopri i progetti.  
Scan and discover the projects.

**464+978**  
Tavolo 2/4 posti con piano in HPL  
2/4 seats table with HPL top



**564+978**  
Tavolo 2/4 posti con piano in HPL  
2/4 seats table with HPL top



**1116+978**  
Tavolo 2/4 posti con piano in HPL  
2/4 seats table with HPL top



# PRODOTTI—PRODUCTS



| Codice/Code<br>Tipologia/Typology   | Disegno/Drawing | Info |
|---|-----------------|------|
| <b>464</b><br>Struttura tavolo per piani HPL<br>Table frame for HPL tops<br>x cod. 978<br>W45 - D45 - H73 Kg 14,0                   |                 |      |
| <b>564</b><br>Struttura tavolo per piani HPL<br>Table frame for HPL tops<br>x cod. 978<br>W51 - D51 - H73 Kg 7,3                    |                 |      |
| <b>1116</b><br>Struttura tavolo media per piani HPL<br>Medium table frame for HPL tops<br>x cod. 978<br>W65,5 - D65,5 - H73 Kg 11,0 |                 |      |
| <b>978</b><br>Piano in HPL per tavolo 2/4 posti<br>HPL top for 2/4 seats table<br>x cod. 464, 564, 1116<br>W79 - D79 - H1 Kg 10,5   |                 |      |

## COLORI STRUTTURA COD. 464—FRAME COLORS COD. 464

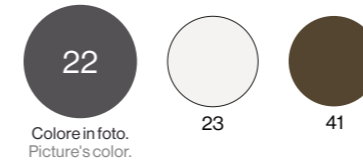

## COLORI STRUTTURA COD. 564—FRAME COLORS COD. 564

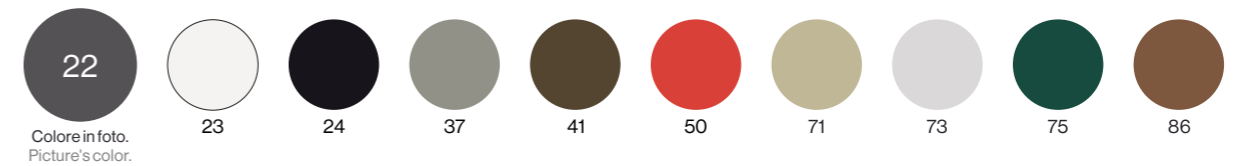

## COLORI STRUTTURA COD. 1116—FRAME COLORS COD. 1116

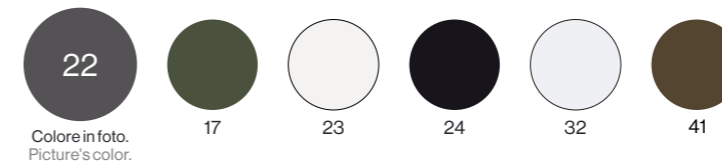

## COLORI PIANI HPL COD. 978—HPL TOPS COLORS COD. 978

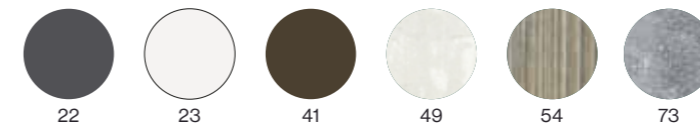

# HPL TOPS

Design by EMU



Scansiona e scopri i progetti.  
Scan and discover the projects.

1117+979

Tavolo 4 posti con piano in HPL

4 seats table with HPL top



## PRODOTTI—PRODUCTS



| Codice/Code<br>Tipologia/Typology | Disegno/Drawing | Info |
|-----------------------------------|-----------------|------|
|-----------------------------------|-----------------|------|

1117

Struttura tavolo grande per piani HPL

Big table frame for HPL tops

x cod. 979

W73 - D73 - H73 Kg 12,0

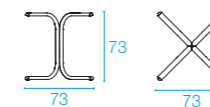

979

Piano in HPL per tavolo 4 posti

HPL top for 4 seats table

x cod. 1117

W89 - D89 - H1 Kg 13,3

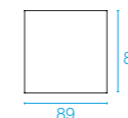

COLORI STRUTTURA COD. 1117—FRAME COLORS COD. 1117

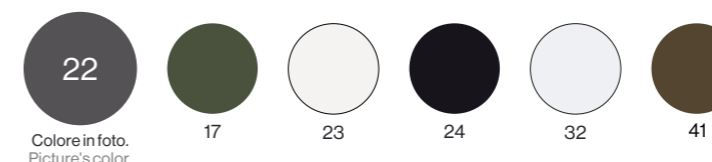

COLORI PIANI HPL COD. 979—HPL TOPS COLORS COD. 979

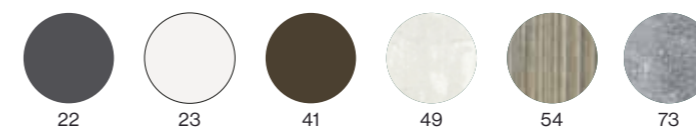

### PLUS

• Utilizzabile con le basi delle collezioni Round, Darwin e Table System.

Suitable to the bases of Round, Darwin and Table System collections.

• L'HPL è un materiale composito di strati di carta kraft e carta decorativa impregnati di resine polimeriche pressati ad alte temperature, con importanti proprietà meccaniche.

HPL is a composite material of layers of kraft paper and decorative paper impregnated with polymer resins pressed at high temperatures, with important mechanical properties.

• 6 differenti versioni tra colori pieni e colori che simulano i materiali del legno e del cemento.

6 different versions between plain colors and colors that simulate the wood and cement's materials.

• Pregi HPL: oltre ai particolari effetti "naturali", i piani HPL sono resistenti ai graffi, urti, usura, vapore, calore, macchie e luce.— In addition to the special natural effects, HPL surfaces are resistant to scratches, shocks, wear, steam, heat, stains and light.



Scansiona e scopri i progetti.  
Scan and discover the projects.

569  
Tavolo tondo 5 posti  
5 seats round table



Tondino di acciaio zincato piegato con macchine a controllo numerico che dà vita ad un motivo estetico originale, esclusivo ed iconico.  
Hot-dip zincated steel bar bent with numerical control machines that gives life to an original, exclusive and iconic aesthetic motif.

570  
Tavolo tondo 6 posti  
6 seats round table



Piano in lamiera prezincata a caldo di ampie dimensioni capace di ospitare 6 posti tavola.  
Pre hot-dip zincated sheet.  
Large table top up to 6 seating.

## PRODOTTI—PRODUCTS

| Codice/Code<br>Tipologia/Typology | Disegno/Drawing | Info |
|-----------------------------------|-----------------|------|
|-----------------------------------|-----------------|------|

569

Tavolo tondo 5 posti  
5 seats round table  
ø105 - H74  
Kg 22,2

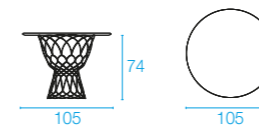

570

Tavolo tondo 6 posti  
6 seats round table  
ø130 - H74  
Kg 29,2

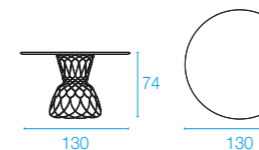

### COLORI STRUTTURA—FRAME COLORS

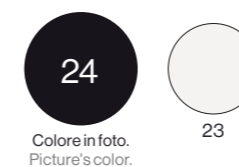

24  
Colore in foto.  
Picture's color.

23

## PLUS

- Tavoli con piano in lamiera zincata a caldo, disponibili in diverse dimensioni.  
Tables with hot-dip zincated sheet top, available in different sizes.
- Struttura saldata a proiezione, cataforizzata in un unico pezzo che offre un'alta resistenza agli agenti atmosferici anche nei punti di giuntura.—Spot welded frame cataphorised in a single piece to increase the resistance to oxidation due to weathering even on the most critical points.
- Sottopiedi in nylon trasparente per maggiore stabilità su suolo irregolare; elemento comune a sedute, tavoli e vasi.—Transparent nylon feet for a better stability on irregular floor; element for seats, tables and vases.

# ROUND

Design by Christophe Pillet



Scansiona e scopri i progetti.  
Scan and discover the projects.

472  
Tavolo quadrato 2 posti  
2 seats square table



471  
Tavolo quadrato 2 posti  
2 seats square table



473  
Tavolo quadrato 2/4 posti  
2/4 seats square table

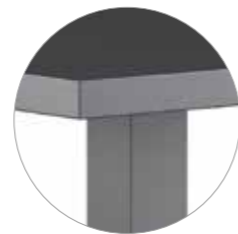

Piano in lamiera piena zincata a caldo preferito nell'utilizzo contract perché protegge le gambe in caso di caduta di liquidi sulla sua superficie.  
Solid table top with hot-dip zincated steel sheet preferred in contract use since it protects the legs in case fluids fall on its surface.

## PRODOTTI—PRODUCTS



| Codice/Code<br>Tipologia/Typology  | Disegno/Drawing | Info | TEST              |
|--|-----------------|------|-------------------|
| 472<br>Tavolo quadrato 2 posti<br>2 seats square table<br>W60 - D60 - H75<br>Kg 20,0     |                 |      |                   |
| 471<br>Tavolo quadrato 2 posti<br>2 seats square table<br>W70 - D70 - H75<br>Kg 22,0     |                 |      |                   |
| 473<br>Tavolo quadrato 2/4 posti<br>2/4 seats square table<br>W80 - D80 - H75<br>Kg 27,2 |                 |      | EN581-1 / EN581-3 |

### COLORI STRUTTURA—FRAME COLORS

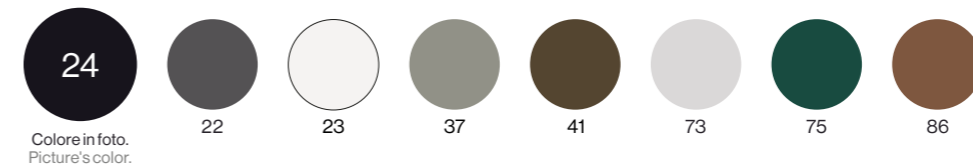

### PLUS

• Struttura cod. 464: possibili personalizzazioni con piani HPL.  
Frame cod. 464: possible customizations with HPL table tops.

# ROUND

Design by Christophe Pillet



Scansiona e scopri i progetti.  
Scan and discover the projects.

470  
Tavolo tondo 4 posti  
4 seats round table



474  
Tavolo rettangolare 4 posti  
4 seats rectangular table



475  
Tavolo alto 2 posti  
2 seats counter table



476  
Tavolo rettangolare 2 posti  
2 seats rectangular table



Sottopiedi regolabili per una migliore stabilità su superfici irregolari.  
Adjustable feet for a better stability on uneven surfaces.

## PRODOTTI—PRODUCTS



| Codice/Code<br>Tipologia/Typology  | Disegno/Drawing | Info | TEST            |
|--|-----------------|------|-----------------|
| 470<br>Tavolo tondo 4 posti<br>4 seats round table<br>ø90 - H75<br>Kg 23,0                     |                 |      |                 |
| 474<br>Tavolo rettangolare 4 posti<br>4 seats rectangular table<br>W120 - D80 - H75<br>Kg 41,8 |                 |      |                 |
| 475<br>Tavolo alto 2 posti<br>2 seats counter table<br>W60 - D60 - H105<br>Kg 23,5             |                 |      |                 |
| 476<br>Tavolo rettangolare 2 posti<br>2 seats rectangular table<br>W70 - D50 - H75<br>Kg 20,1  |                 |      | EN581-1/EN581-3 |

### COLORI STRUTTURA—FRAME COLORS

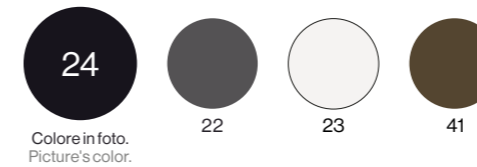



**254+256**  
Tavolo 2/4 posti con piano in HPL  
2/4 seats table with HPL top



Palo centrale con base a crociera per l'ottimizzazione dell'ingombro a terra delle sedute in uso.  
Central pole with cross base to safe space when seats in use.

**254+257**  
Tavolo 2/4 posti con piano in teak  
2/4 seats table with teak top



Sottopiedi regolabili che permettono di livellare il tavolo e garantire stabilità anche su suoli più irregolari.  
Adjustable feet to level the table and ensure its stability even on the most irregular floors.

**255+258**  
Tavolo alto 2 posti con piano in HPL  
2 seats counter table with HPL top



## PRODOTTI—PRODUCTS



| Codice/Code<br>Tipologia/Typology   | Disegno/Drawing | Info | TEST                              |
|---|-----------------|------|-----------------------------------|
| <b>254</b><br>Struttura tavolo<br>Table frame<br>x cod. 256, 257<br>W75 - D75 - H72<br>Kg 3,4                                   |                 |      | EN581-1/EN581-3<br>(cod. 254+257) |
| <b>255</b><br>Struttura tavolo<br>Table frame<br>x cod. 258<br>W66 - D66 - H103<br>Kg 5,2                                       |                 |      | EN581-1/EN581-3<br>(cod. 255+258) |
| <b>256</b><br>Piano in HPL<br>per tavolo 2/4 posti<br>HPL top for 2/4 seats table<br>x cod. 254<br>W79 - D79 - H1,2<br>Kg 10,2  |                 |      |                                   |
| <b>257</b><br>Piano in teak<br>per tavolo 2/4 posti<br>Teak top for 2/4 seats table<br>x cod. 254<br>W79 - D79 - H1,2<br>Kg 5,4 |                 |      | EN581-1/EN581-3<br>(cod. 254+257) |
| <b>258</b><br>Piano in HPL<br>per tavolo 2 posti<br>HPL top for 2 seats table<br>x cod. 255<br>W60 - D60 - H1,2<br>Kg 5,9       |                 |      | EN581-1/EN581-3<br>(cod. 255+258) |

COLORI STRUTTURA E PIANO IN HPL X COD. 254, 255, 256, 258—FRAME AND HPL TOP COLORS X COD. 254, 255, 256, 258

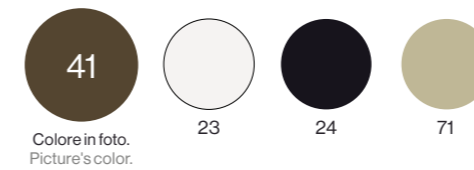

COLORI PIANO IN TEAK X COD. 257—TEAK TOP COLORS X COD. 257



### PLUS

- Struttura in tubolare di lega di alluminio.—Tubular aluminium alloy frame.
- Due opzioni per il piano: teak FSC® per un piacevole effetto tattile e visivo, HPL come pratica soluzione. Possibilità di personalizzazione con piano cliente.—Two material option for the top: FSC® teak for a pleasant touch, look and feel and HPL as handy solution. Possibility of customization with client top.

# TABLE SYSTEM

Design by EMU



Scansiona e scopri i progetti.  
Scan and discover the projects.



Piano bordo basso—Low border top



1130

Tavolo abbattibile bordo basso 2 posti  
2 seats low border collapsible table



1131

Tavolo abbattibile bordo basso 2 posti  
2 seats low border collapsible table



1132

Tavolo abbattibile bordo basso 2/4 posti  
2/4 seats low border collapsible table



1135

Tavolo abbattibile bordo basso 2 posti  
2 seats low border collapsible table



## PRODOTTI—PRODUCTS

| Codice/Code<br>Tipologia/Typology  | Disegno/Drawing | Info |
|--|-----------------|------|
| 1130<br>Tavolo abbattibile bordo basso 2 posti<br>2 seats low border collapsible table<br>W60 - D60 - H75<br>Kg 15,0     |                 |      |
| 1131<br>Tavolo abbattibile bordo basso 2 posti<br>2 seats low border collapsible table<br>W70 - D70 - H75<br>Kg 17,7     |                 |      |
| 1132<br>Tavolo abbattibile bordo basso 2/4 posti<br>2/4 seats low border collapsible table<br>W80 - D80 - H75<br>Kg 19,8 |                 |      |
| 1135<br>Tavolo abbattibile bordo basso 2 posti<br>2 seats low border collapsible table<br>W60 - D70 - H75<br>Kg 17,9     |                 |      |

### COLORI STRUTTURA—FRAME COLORS

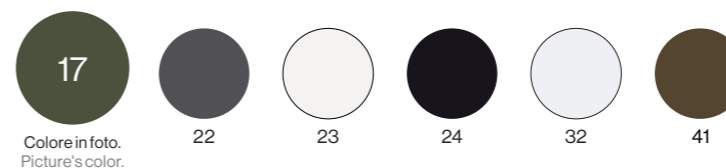

### PLUS

- Piani in lamiera piena zincata a caldo preferiti nell'utilizzo contract perché protegge le gambe in caso di caduta di liquidi sulla sua superficie.— Solid table top with hot-dip zincated steel sheet more suitable for contract use since it protects the legs in case fluids fall on its surface.
- Struttura in acciaio zincato dentro e fuori.— Inside and outside frame in hot-dip zincated steel.
- N.4 sottopiedi regolabili.— N.4 adjustable feet.
- Tavoli con piano abbattibile - possibilità di scegliere due diverse tipologie di bordi dei piani: bordo basso e bordo squadrato a seconda dello stile della seduta in abbinamento.— Collapsible tables - you can choose two different types of tops: low border and square border according to the style of the matching seat.
- Ampia gamma di dimensione piani.— Table tops available in different sizes.
- Possibilità di personalizzazione con piano cliente.— Possibility of customization with client top.

# TABLE SYSTEM

Design by EMU



Scansiona e scopri i progetti.  
Scan and discover the projects.

**1136**  
Tavolo abbattibile bordo quadrato 2 posti  
2 seats square border collapsible table



**1137**  
Tavolo abbattibile bordo quadrato 2 posti  
2 seats square border collapsible table



**1138**  
Tavolo abbattibile bordo quadrato 2/4 posti  
2/4 seats square border collapsible table



**1140**  
Tavolo abbattibile bordo quadrato 2/4 posti  
2/4 seats square border collapsible table



**1142**  
Tavolo abbattibile bordo quadrato 2 posti  
2 seats square border collapsible table

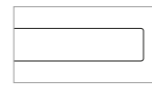

Piano bordo squadrato—Square border top

## PRODOTTI—PRODUCTS

| Codice/Code<br>Tipologia/Typology  | Disegno/Drawing | Info |
|--|-----------------|------|
| <b>1136</b><br>Tavolo abbattibile bordo quadrato 2 posti<br>2 seats round border collapsible table<br>W60 - D60 - H75<br>Kg 15,3     |                 |      |
| <b>1137</b><br>Tavolo abbattibile bordo quadrato 2 posti<br>2 seats round border collapsible table<br>W70 - D70 - H75<br>Kg 17,9     |                 |      |
| <b>1138</b><br>Tavolo abbattibile bordo quadrato 2/4 posti<br>2/4 seats round border collapsible table<br>W80 - D80 - H75<br>Kg 20,0 |                 |      |
| <b>1140</b><br>Tavolo abbattibile bordo quadrato 2/4 posti<br>2/4 seats round border collapsible table<br>ø80 - H75<br>Kg 18,7       |                 |      |
| <b>1142</b><br>Tavolo abbattibile bordo quadrato 2 posti<br>2 seats round border collapsible table<br>W60 - D70 - H75<br>Kg 18,2     |                 |      |

### COLORI STRUTTURA—FRAME COLORS

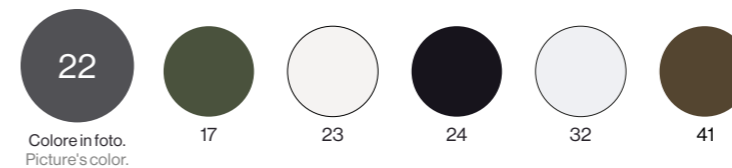



# TABLE SYSTEM

Design by EMU



Scansiona e scopri i progetti.  
Scan and discover the projects.



1151

Tavolo bordo tondo 2 posti  
2 seats round border table



1152

Tavolo bordo tondo 2 posti  
2 seats round border table



1153

Tavolo bordo tondo 2/4 posti  
2/4 seats round border table

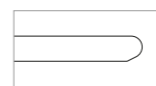

Piano bordo tondo—Round border top

## PRODOTTI—PRODUCTS

| Codice/Code<br>Tipologia/Typology   | Disegno/Drawing | Info |
|---|-----------------|------|
| <b>1151</b><br>Tavolo bordo tondo 2 posti<br>2 seats round border table<br>W60 - D60 - H74<br>Kg 13,6     |                 |      |
| <b>1152</b><br>Tavolo bordo tondo 2 posti<br>2 seats round border table<br>W70 - D70 - H74<br>Kg 16,5     |                 |      |
| <b>1153</b><br>Tavolo bordo tondo 2/4 posti<br>2/4 seats round border table<br>W80 - D80 - H74<br>Kg 17,8 |                 |      |

## COLORI STRUTTURA—FRAME COLORS

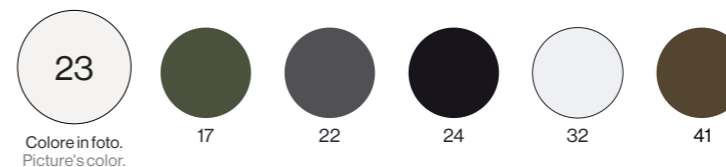

## PLUS

- Piani in lamiera piena zincata a caldo preferiti nell'utilizzo contract perché protegge le gambe in caso di caduta di liquidi sulla sua superficie.— Solid table top with hot-dip zincated steel sheet more suitable for contract use since it protects the legs in case fluids fall on its surface.
- Struttura in acciaio zincato dentro e fuori.— Inside and outside frame in hot-dip zincated steel.
- N.4 sottopiedi regolabili.— N.4 adjustable feet.
- Tavoli con piano fisso - possibilità di scegliere tre diverse tipologie di bordi dei piani: bordo basso, bordo squadrato e bordo tondo a seconda dello stile della seduta in abbinamento.— Fixed tables - you can choose three different types of border tops: low border, square border and round border according to the style of the matching seat.
- Ampia gamma di dimensione piani.— Table tops available in different sizes.
- Possibilità di personalizzazione con piano cliente.— Possibility of customization with client top.

# TABLE SYSTEM

Design by EMU



Scansiona e scopri i progetti.  
Scan and discover the projects.

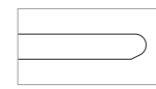

Piano bordo tondo—Round border top



1154

Tavolo bordo tondo 2 posti  
2 seats round border table



1155

Tavolo bordo tondo 2/4 posti  
2/4 seats round border table



1156

Tavolo bordo tondo 5/6 posti  
5/6 seats round border table



## PRODOTTI—PRODUCTS

| Codice/Code<br>Tipologia/Typology   | Disegno/Drawing | Info |
|---|-----------------|------|
| 1154<br>Tavolo bordo tondo 2 posti<br>2 seats round border table<br>ø71 - H74<br>Kg 14,2      |                 |      |
| 1155<br>Tavolo bordo tondo 2/4 posti<br>2/4 seats round border table<br>ø80 - H74<br>Kg 15,2  |                 |      |
| 1156<br>Tavolo bordo tondo 5/6 posti<br>5/6 seats round border table<br>ø117 - H74<br>Kg 25,0 |                 |      |

## COLORI STRUTTURA—FRAME COLORS

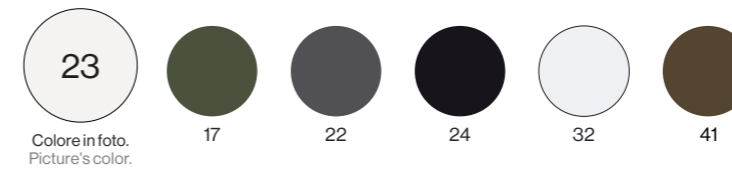

# TABLE SYSTEM

Design by EMU



Scansiona e scopri i progetti.  
Scan and discover the projects.

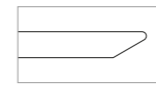

Piano bordo basso—Low border top



**1160**  
Tavolo bordo basso 2 posti  
2 seats low border table



**1161**  
Tavolo bordo basso 2 posti  
2 seats low border table



**1162**  
Tavolo bordo basso 2/4 posti  
2/4 seats low border table



**1164**  
Tavolo bordo basso 2 posti  
2 seats low border table



## PRODOTTI—PRODUCTS

| Codice/Code<br>Tipologia/Typology   | Disegno/Drawing | Info |
|---|-----------------|------|
| <b>1160</b><br>Tavolo bordo basso 2 posti<br>2 seats low border table<br>W60 - D60 - H74<br>Kg 15,1     |                 |      |
| <b>1161</b><br>Tavolo bordo basso 2 posti<br>2 seats low border table<br>W70 - D70 - H74<br>Kg 18,3     |                 |      |
| <b>1162</b><br>Tavolo bordo basso 2/4 posti<br>2/4 seats low border table<br>W80 - D80 - H74<br>Kg 20,5 |                 |      |
| <b>1164</b><br>Tavolo bordo basso 2 posti<br>2 seats low border table<br>W60 - D70 - H74<br>Kg 16,0     |                 |      |

## COLORI STRUTTURA—FRAME COLORS

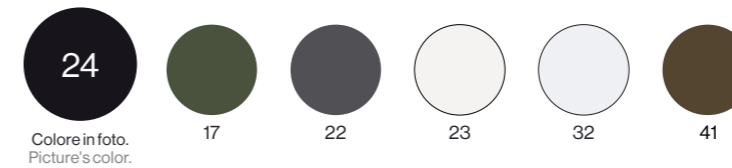

# TABLE SYSTEM

Design by EMU



Scansiona e scopri i progetti.  
Scan and discover the projects.



**1166**  
Tavolo bordo squadrato 2 posti  
2 seats square border table



**1167**  
Tavolo bordo squadrato 2 posti  
2 seats square border table



**1168**  
Tavolo bordo squadrato 2/4 posti  
2/4 seats square border table



**1169**  
Tavolo bordo squadrato 4 posti  
4 seats square border table

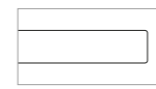

Piano bordo squadrato—Square border top

## PRODOTTI—PRODUCTS

| Codice/Code<br>Tipologia/Typology  | Disegno/Drawing | Info |
|--|-----------------|------|
| <b>1166</b><br>Tavolo bordo squadrato 2 posti<br>2 seats square border table<br>W60 - D60 - H75<br>Kg 16,0     |                 |      |
| <b>1167</b><br>Tavolo bordo squadrato 2 posti<br>2 seats square border table<br>W70 - D70 - H75<br>Kg 19,3     |                 |      |
| <b>1168</b><br>Tavolo bordo squadrato 2/4 posti<br>2/4 seats square border table<br>W80 - D80 - H75<br>Kg 21,2 |                 |      |
| <b>1169</b><br>Tavolo bordo squadrato 4 posti<br>4 seats square border table<br>W90 - D90 - H75<br>Kg 24,5     |                 |      |

## COLORI STRUTTURA—FRAME COLORS

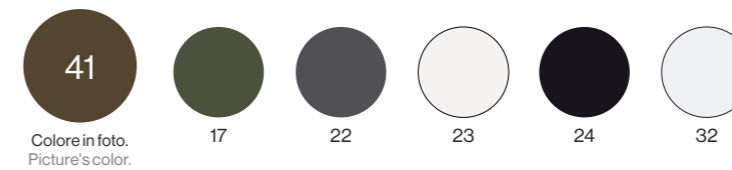

# TABLE SYSTEM

Design by EMU



Scansiona e scopri i progetti.  
Scan and discover the projects.

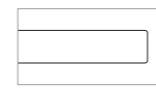

Piano bordo squadrato—Square border top



**1170**  
Tavolo bordo squadrato 2/4 posti  
2/4 seats square border table



**1171**  
Tavolo bordo squadrato 5/6 posti  
5/6 seats square border table



**1173**  
Tavolo bordo squadrato 2 posti  
2 seats square border table



## PRODOTTI—PRODUCTS

| Codice/Code<br>Tipologia/Typology  | Disegno/Drawing | Info |
|--|-----------------|------|
| <b>1170</b><br>Tavolo bordo squadrato 2/4 posti<br>2/4 seats square border table<br>ø80 - H75<br>Kg 17,4   |                 |      |
| <b>1171</b><br>Tavolo bordo squadrato 5/6 posti<br>5/6 seats square border table<br>ø117 - H75<br>Kg 26,4  |                 |      |
| <b>1173</b><br>Tavolo bordo squadrato 2 posti<br>2 seats square border table<br>W60 - D70 - H75<br>Kg 17,0 |                 |      |

### COLORI STRUTTURA—FRAME COLORS

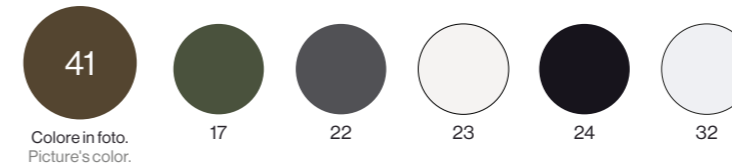



Scansiona e scopri  
i progetti.  
Scan and discover  
the projects.



726  
Tavolo smart  
Smart table



Il palo centrale è regolabile e permette un'altezza minima di 46 cm e una massima di 70 cm. L'altezza può essere bloccata tramite pratico sistema di bloccaggio.

The central pole can be adjusted and allows 46 cm as minimum height and 70 cm as maximum one. The height can be fixed thanks to a handy clamping system.

| Codice/Code<br>Tipologia/Typology | Disegno/Drawing | Info |
|-----------------------------------|-----------------|------|
|-----------------------------------|-----------------|------|

726

Tavolo smart  
Smart table

W65 - D49 - H46/70

Kg 4,9

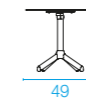
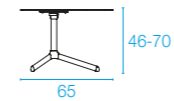

## COLORI STRUTTURA—FRAME COLORS

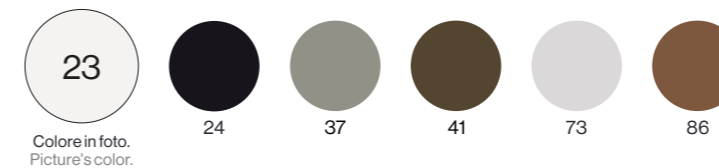

Colore in foto.  
Picture's color.

## PLUS

- Utile piano di appoggio per tutte le sedute sia per un utilizzo di smart working sia come tavolo di servizio per snack e aperitivi.— It's a helpful worktop matching with whatever seating, good for many uses like working from home. It's a side table for snacks and drinks as well.
- La base, realizzata a raggiera, ne permette l'utilizzo con tutte le sedute della nostra collezione. Its radial base allows matching it with all EMU seatings.



Scansiona e scopri i progetti.  
Scan and discover the projects.

900  
Tavolo tondo 2 posti  
2 seats round table



902  
Tavolo tondo 2/3 posti  
2/3 seats round table



## PRODOTTI—PRODUCTS



| Codice/Code<br>Tipologia/Typology | Disegno/Drawing | Info |
|-----------------------------------|-----------------|------|
|-----------------------------------|-----------------|------|

|   |  |  |
|---|--|--|
| <b>900</b><br>Tavolo tondo 2 posti<br>2 seats round table<br>ø60 - H75<br>Kg 12,2 |  |  |
|---|--|--|

|   |  |  |
|---|--|--|
| <b>902</b><br>Tavolo tondo 2/3 posti<br>2/3 seats round table<br>ø80 - H75<br>Kg 16,7 |  |  |
|---|--|--|

### COLORI STRUTTURA—FRAME COLORS

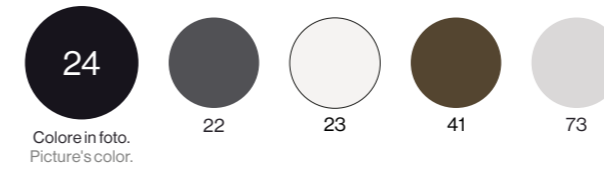

### PLUS

- Piano in lamiera piena preferito nell'utilizzo contract perché protegge le gambe in caso di caduta di liquidi sulla sua superficie.—Solid sheet metal top preferred in contract use because it protects the legs in case liquids fall on its surface.
- Tavolo a base tonda con palo centrale tondo e piano realizzato in lamiera zincata a caldo. A table with a round base and a round central pole. Its pole is made of a hot-dip zincated sheet.
- Pratico e facile da montare.—Easy and practical assembly.
- Il basamento realizzato in lamiera di acciaio garantisce un'ottima stabilità. Base made of steel sheet that ensures an excellent stability.
- Elegante ed essenziale nelle linee si combina con tutti i prodotti realizzati con tubi tondi. It matches with all products made with round pipes. Elegant and essential design.

# EMU NEL MONDO EMU IN THE WORLD

ROUND—THE ORANGE CUBE—FRANCE



LYZE—BIO'S KITCHEN—ITALY



RE-TROUVÉ—HOTEL ME SITGES—SPAIN



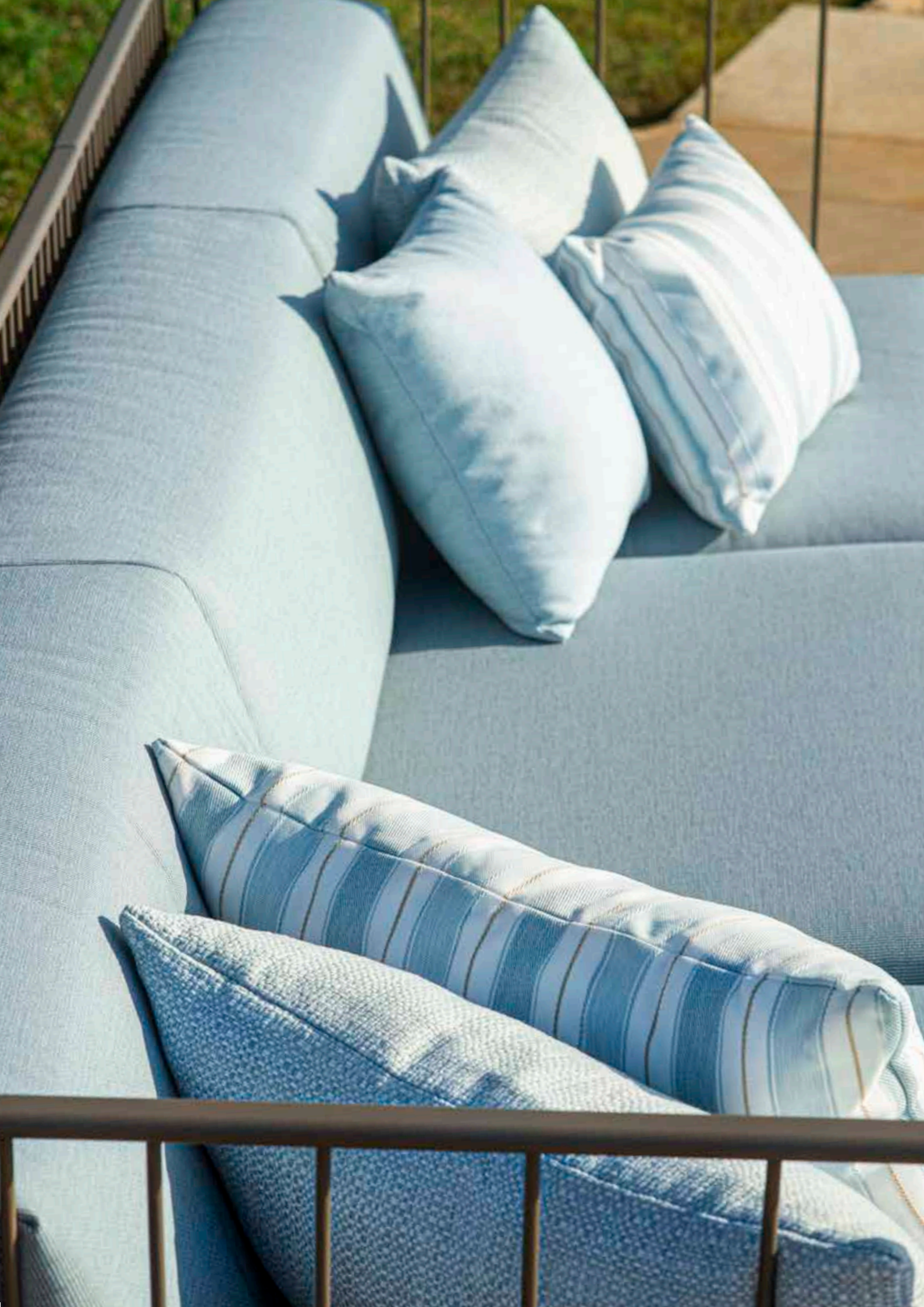

# POLTRONE E DIVANI ARMCHAIRS AND SOFAS

Versatilità, comfort, modularità e ricerca estetica caratterizzano le poltrone e i divani EMU. L'ampia gamma di tessuti permette di personalizzare i cuscini di seduta, così come i cuscini decorativi offerti in varie misure, per creare eleganti soluzioni di arredo. L'offerta si completa con sofa a 2 posti e 3 posti ed alcuni accessori, come tavoli orientabili, coffee table e snack table.

EMU modular armchairs and sofas are versatile, comfortable and elegant. The extensive range of fabrics offers bespoke seating cushions and decorative cushions in various sizes to create elegant furnishings. The offer of 2 and 3-seater sofas comes complete with some accessories, such as adjustable tables, coffee tables and snack tables.

## INDEX

|     |           |     |
|-----|-----------|-----|
| 208 | CANNOLE   | ●   |
| 214 | CROSS     | ●   |
| 218 | DOCK      | ●   |
| 222 | IVY       | ●   |
| 224 | TAMI      | ● ● |
| 232 | TERRAMARE | ●   |

LEGENDA—LEGEND  
● Acciaio—Steel  
● Alluminio—Aluminium  
● Legno—Wood



Scansiona e scopri i progetti.  
Scan and discover the projects.



## 1080

Poltrona

Lounge chair

W96 - D90 - H79

C/1080 + C/1081 + C/1082 + C/1083



Tutte le componenti in acciaio, i tondini e i tubi sono zincati a caldo internamente ed esternamente.  
All steel components, bars and pipes are both internally and externally hot-dip zincated.

\* Cuscino visibile in foto 900/01 Cielo—Cushion in the picture 900/01 Sky

## 1085

Pouf

Pouf

W85 - D85 - H43

C/1085



\* Cuscino visibile in foto 900/01 Cielo—Cushion in the picture 900/01 Sky

## 1082+1083

Divano 2 posti—2-seater sofa  
W180 - D90 - H79

2x C/1080 + 2x C/1081 + C/1082 + C/1083

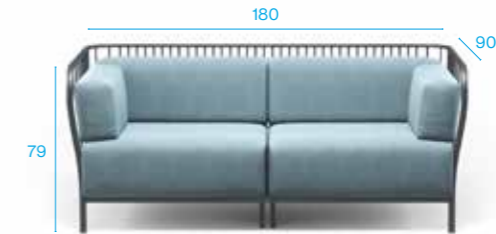

## 1081+1082+1083

Divano 3 posti—3-seater sofa  
W265 - D90 - H79

3x C/1080 + 3x C/1081 + C/1082 + C/1083



## 1081+1082+1083+1085

Divano 3 posti con daybed  
3-seater sofa with daybed  
W265 - D175 - H79

3x C/1080 + 3x C/1081 + C/1082 + C/1083 + C/1086



## 2x1081+1082+1083+1084

Divano angolare 5 posti  
5-seater corner sofa  
W265 - D265 - H79

4x C/1080 + 4x C/1081 + C/1082 + C/1083 + C/1084 + C/1085



## 1082+1083+2x1085

Daybed matrimoniale  
Double daybed  
W180 - D175 - H79

2x C/1080 + 2x C/1081 + C/1082 + C/1083 + 2x C/1086



\* Cuscino visibile in foto 900/01 Cielo—Cushion in the picture 900/01 Sky

# PRODOTTI—PRODUCTS

| Codice/Code<br>Tipologia/Typology   | Disegno/Drawing | Info | TEST            |
|---|-----------------|------|-----------------|
| <b>1080</b><br>Struttura poltrona<br>Lounge chair frame<br>W96 - D90 - H79<br>Kg 20,4 |                 |      | EN581-1/EN581-2 |
| <b>1081</b><br>Modulo lineare<br>Straight module<br>W85 - D90 - H79<br>Kg 13,5        |                 |      |                 |
| <b>1082</b><br>Modulo terminale dx<br>Right end module<br>W90 - D90 - H79<br>Kg 16,9  |                 |      |                 |
| <b>1083</b><br>Modulo terminale sx<br>Left end module<br>W90 - D90 - H79<br>Kg 16,9   |                 |      |                 |
| <b>1084</b><br>Modulo angolare<br>Corner module<br>W90 - D90 - H79<br>Kg 19,6         |                 |      |                 |
| <b>1085</b><br>Modulo pouf<br>Pouf module<br>W85 - D85 - H20<br>Kg 9,6                |                 |      |                 |

## COLORI STRUTTURA—FRAME COLORS

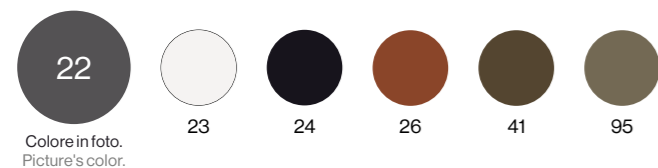

## ALTRI PRODOTTI IN COLLEZIONE—OTHER COLLECTION'S PRODUCTS

210



**CANNOLÉ**  
Cod. 1087  
Tavolo basso grande  
Big coffee table  
PAG. 244



**CANNOLÉ**  
Cod. 1088  
Tavolo basso piccolo  
Small coffee table  
PAG. 244

# CUSCINI—CUSHIONS











| Codice/Code<br>Tipologia/Typology  | Colori tessuto<br>Fabric colors | Categoria tessuto<br>Fabric category   |
|--|---------------------------------|--|
| <b>C/1080</b><br>Cuscino seduta—Seat cushion<br>x cod. 1080, 1081, 1082, 1083<br>W84 - D23 - H84<br>Kg 4,4                     |                                 | Vedi pg. 213<br>Look at pg. 213<br><br>Tessuti Basic (Vedi riepilogo pg. 213)<br>Tessuti Standard (Vedi riepilogo pg. 213)*<br>Tessuti Premium (Vedi riepilogo pg. 213)<br>Basic Fabrics (Look at pg. 213)<br>Standard Fabrics (Look at pg. 213)*<br>Premium Fabrics (Look at pg. 213) |
| <b>C/1081</b><br>Cuscino schienale—Back cushion<br>x cod. 1080, 1081, 1082, 1083<br>W84 - D30 - H33<br>Kg 1,6                  |                                 |  |
| <b>C/1082</b><br>Cuscino bracciolo dx—Right armrest cushion<br>x cod. 1080, 1082<br>W69 - D18 - H31<br>Kg 0,9                  |                                 |  |
| <b>C/1083</b><br>Cuscino bracciolo sx—Left armrest cushion<br>x cod. 1080, 1083<br>W69 - D18 - H31<br>Kg 0,9                   |                                 |  |
| <b>C/1084</b><br>Cuscino schienale angolare—Corner back cushion<br>x cod. 1084<br>W84 - D33 - H30<br>W84 - D33 - H30<br>Kg 2,8 |                                 |  |
| <b>C/1085</b><br>Cuscino seduta angolare—Corner seat cushion<br>x cod. 1084<br>W84 - D23 - H84<br>Kg 4,4                       |                                 |  |
| <b>C/1086</b><br>Cuscino pouf—Pouf cushion<br>x cod. 1085<br>W84 - D23 - H84<br>Kg 4,0   |                                 |  |

\* Cuscino visibile in foto 900/01 Cielo—Cushion in the picture 900/01 Sky

## PLUS

- La spaziatura dei tondini irregolare segue una sapiente gradualità che conferisce grande personalità al design del prodotto.—The irregular spacing of the bars follows a wise gradualness that gives great personality to the product design.
- Fissaggio cuscino con antiscivolo.—Non-slip fastening cushion.
- Giunti di accoppiamento e viterie in acciaio inossidabile.—Stainless steel coupling joints and screws.
- Il fissaggio del cuscino del pouf alla struttura è assicurato da velcro.  
The pouf cushion is fastened to the frame by velcro system.

211

| Codice/Code<br>Tipologia/Typology   | Colori tessuto<br>Fabric colors   | Categoria tessuto<br>Fabric category  |
|---|---|---|
| <b>C/701</b><br>Cuscino decorativo<br>Decorative cushion<br>x cod. 1080, 1081, 1082, 1083, 1084<br>W40 - D40 - H15 Kg 0,7 |       | Tessuti Basic (Vedi riepilogo pg. 325)<br>Tessuti Standard (Vedi riepilogo pg. 325)<br>Tessuti Premium (Vedi riepilogo pg. 325)<br>Basic Fabrics (Look at pg. 325)<br>Standard Fabrics (Look at pg. 325)<br>Premium Fabrics (Look at pg. 325) |
| <b>C/705</b><br>Cuscino decorativo<br>Decorative cushion<br>x cod. 1080, 1081, 1082, 1083, 1084<br>W45 - D35 - H15 Kg 0,6 |       |   |
| <b>C/706</b><br>Cuscino decorativo<br>Decorative cushion<br>x cod. 1080, 1081, 1082, 1083, 1084<br>W60 - D40 - H20 Kg 0,8 |       |   |
| <b>FC/729</b><br>Cover x cod. 1080  |       |   |
| <b>FC/742</b><br>Cover x cod. 1082+1083   |       |   |
| <b>FC/743</b><br>Cover x cod. 1081+1082+1083  |   |   |
| <b>FC/1085</b><br>Cover x cod. 1085   |   |   |



## TESSUTI CUSCINI—CUSHION FABRICS

### C/1080 - C/1081 - C/1082 - C/1083 - C/1084 - C/1085 - C/1086

| Composizione/Categoria tessuti<br>Composition/Fabrics category | Colori<br>Colors |
|--|------------------|
|--|------------------|

#### TESSUTI BASIC—BASIC FABRICS

|                  |        |
|------------------|--------|
| Acrilico—Acrylic | 700/4  |
|                  | 700/10 |
|                  | 700/12 |
|                  | 700/13 |
|                  | 700/14 |

#### TESSUTI STANDARD—STANDARD FABRICS

|  |        |
|--|--------|
| 85% Polipropilene, 15% Poliestere—85% Polypropylene, 15% Polyester | 900/01 |
|  | 900/02 |
|  | 900/03 |
|  | 900/05 |
|  | 900/06 |
|  | 900/07 |
|  | 900/08 |
|  | 900/09 |
|  | 900/13 |
|  | 900/14 |
| 900/17   |        |
| Acrilico—Acrylic   | 900/18 |
| Polipropilene—Polypropylene  | 900/71 |
|  | 900/75 |
|  | 900/77 |
|  | 900/79 |

#### TESSUTI PREMIUM—PREMIUM FABRICS

|  |        |
|--|--------|
| CAT. D<br>Visitare il nostro sito web <a href="http://www.emu.it">www.emu.it</a> —Visit our website <a href="http://www.emu.it">www.emu.it</a> | 600/08 |
|  | 600/09 |
|  | 600/15 |
|  | 600/17 |
|  | 600/24 |
|  | 600/26 |
|  | 600/27 |
| CAT. C<br>Visitare il nostro sito web <a href="http://www.emu.it">www.emu.it</a> —Visit our website <a href="http://www.emu.it">www.emu.it</a> | 900/16 |
|  | 900/19 |
|  | 600/02 |
|  | 600/07 |
|  | 600/14 |
| CAT. B<br>Visitare il nostro sito web <a href="http://www.emu.it">www.emu.it</a> —Visit our website <a href="http://www.emu.it">www.emu.it</a> | 600/16 |
|  | 600/18 |
|  | 600/03 |
|  | 600/10 |
| CAT. A<br>Visitare il nostro sito web <a href="http://www.emu.it">www.emu.it</a> —Visit our website <a href="http://www.emu.it">www.emu.it</a> | 600/11 |
|  | 600/12 |
|  | 600/22 |
|  | 600/04 |
|  | 600/06 |
|  | 600/21 |

#### CON TESSUTO CLIENTE—WITH CUSTOMER'S FABRIC

|  |  |
|--|--|
| FABBISOGNO TESSUTO (cm)—FABRIC REQUIRED (cm) | C/1080 132x240, C/1081 132x160, C/1082 132x100, C/1083 132x100<br>C/1084 132x240, C/1085 132x240, C/1086 132x280 |
|--|--|

Ⓢ La caratteristica FLAME RETARDANT indica una capacità di resistenza contro fonti di calore o fuoco.  
Per conoscere nel dettaglio tale caratteristica si prega di far riferimento alle schede tecniche presenti nell'area riservata del sito [www.emu.it](http://www.emu.it)  
The FLAME RETARDANT characteristic is an indication of chemical resistance against sources of heat or fire.  
To find out more about this feature, please refer to the technical data sheets in the reserved area of the website [www.emu.it](http://www.emu.it)



Scansiona e scopri i progetti.  
Scan and discover the projects.



**421+C/421**  
Poltrona  
Lounge chair



Schienale intrecciato in corda di polipropilene.  
Backrest made of wave in polypropylene rope.

**422+C/422**  
Divano  
Sofa



Gambe dal disegno esclusivo in pressofusione di lega di alluminio.  
Legs with an exclusive design made of die-cast aluminium alloy.

## PRODOTTI—PRODUCTS

| Codice/Code<br>Tipologia/Typology | Disegno/Drawing | Info |
|-----------------------------------|-----------------|------|
|-----------------------------------|-----------------|------|

### 421

Poltrona  
Lounge chair  
W66 - D75 - H80  
Kg 17,4

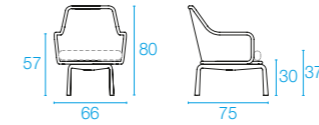

### 422

Divano  
Sofa  
W149 - D79 - H80  
Kg 31,0

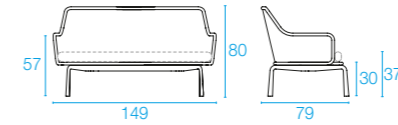

### COLORI STRUTTURA/SEDUTA/SCHIENALE—FRAME/SEAT/BACKREST COLORS

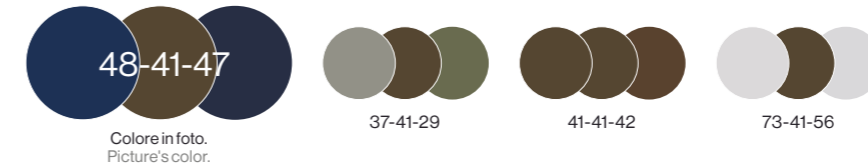

## CUSCINI—CUSHIONS

| Codice/Code<br>Tipologia/Typology  | Colori tessuto<br>Fabric colors | Categoria tessuto<br>Fabric category   |
|--|---------------------------------|--|
| <b>C/421</b><br>Cuscino seduta—Seat cushion<br>x cod. 421<br>W46/53 - D57 - H7 Kg 0,87             |                                 | Vedi pg. 216<br>Look at pg. 216<br><br>Tessuti Basic (Vedi riepilogo pg. 216)<br>Tessuti Standard (Vedi riepilogo pg. 216)*<br>Tessuti Premium (Vedi riepilogo pg. 216)<br>Basic Fabrics (Look at pg. 216)<br>Standard Fabrics (Look at pg. 216)*<br>Premium Fabrics (Look at pg. 216) |
| <b>C/422</b><br>Cuscino seduta—Seat cushion<br>x cod. 422<br>W128/138 - D65 - H7 Kg 2,4            |                                 |  |
| <b>C/701</b><br>Cuscino decorativo—Decorative cushion<br>x cod. 421, 422<br>W40 - D40 - H15 Kg 0,7 |                                 | Vedi pg. 325<br>Look at pg. 325<br><br>Tessuti Basic (Vedi riepilogo pg. 325)<br>Tessuti Standard (Vedi riepilogo pg. 325)<br>Tessuti Premium (Vedi riepilogo pg. 325)<br>Basic Fabrics (Look at pg. 325)<br>Standard Fabrics (Look at pg. 325)<br>Premium Fabrics (Look at pg. 325)   |
| <b>C/705</b><br>Cuscino decorativo—Decorative cushion<br>x cod. 421, 422<br>W45 - D35 - H15 Kg 0,6 |                                 |  |
| <b>C/706</b><br>Cuscino decorativo—Decorative cushion<br>x cod. 421, 422<br>W60 - D40 - H20 Kg 0,8 |                                 |  |

\* Cuscino visibile in foto 900/06 Bronzo—Cushion in the picture 900/06 Bronze

### ALTRI PRODOTTI IN COLLEZIONE—OTHER COLLECTION'S PRODUCTS



CROSS  
Cod. 423  
Tavolo basso  
Coffee table  
PAG. 248

## PLUS

- Struttura schienale braccioli in acciaio zincato a caldo. Lamiera stirata zincata a caldo del sedile.  
Frame of the backrest and armrests made of hot-dip zincated steel. Hot-dip zincated expanded sheet of the seat.
- Fissaggio cuscino con antiscivolo.— Non-slip fastening cushion.
- Cuscini seduta C/421 e C/422 sfoderabili e personalizzabili con un'ampia gamma di tessuti.  
C/421 and C/422 seat cushions are cover removable and customizable with a wide fabric range.



## TESSUTI CUSCINI—CUSHION FABRICS C/421 - C/422

Composizione/Categoria tessuti  
Composition/Fabrics category

Colori  
Colors

### TESSUTI BASIC—BASIC FABRICS

|                  |        |
|------------------|--------|
| Acrilico—Acrylic | 700/4  |
|                  | 700/10 |
|                  | 700/12 |
|                  | 700/13 |
|                  | 700/14 |

### TESSUTI STANDARD—STANDARD FABRICS

|  |        |
|--|--------|
| 85% Polipropilene, 15% Poliestere—85% Polypropylene, 15% Polyester | 900/01 |
|  | 900/02 |
|  | 900/03 |
|  | 900/05 |
|  | 900/06 |
|  | 900/07 |
|  | 900/08 |
|  | 900/09 |
|  | 900/13 |
|  | 900/14 |
|  | 900/17 |
|  | 900/18 |
|  | 900/71 |

|                             |        |
|-----------------------------|--------|
| Polipropilene—Polypropylene | 900/75 |
|                             | 900/77 |
|                             | 900/79 |

### TESSUTI PREMIUM—PREMIUM FABRICS

|  |        |   |
|--|--------|---|
| CAT. D<br>Visitare il nostro sito web <a href="http://www.emu.it">www.emu.it</a> —Visit our website <a href="http://www.emu.it">www.emu.it</a> | 600/08 | ⓧ |
|  | 600/09 | ⓧ |
|  | 600/15 | ⓧ |
|  | 600/17 | ⓧ |
|  | 600/24 | ⓧ |
| CAT. C<br>Visitare il nostro sito web <a href="http://www.emu.it">www.emu.it</a> —Visit our website <a href="http://www.emu.it">www.emu.it</a> | 600/26 | ⓧ |
|  | 600/27 | ⓧ |
|  | 600/28 | ⓧ |
|  | 900/16 | ⓧ |
|  | 900/19 | ⓧ |
| CAT. B<br>Visitare il nostro sito web <a href="http://www.emu.it">www.emu.it</a> —Visit our website <a href="http://www.emu.it">www.emu.it</a> | 600/02 |   |
|  | 600/07 |   |
|  | 600/14 |   |
|  | 600/16 |   |
|  | 600/18 |   |
| CAT. A<br>Visitare il nostro sito web <a href="http://www.emu.it">www.emu.it</a> —Visit our website <a href="http://www.emu.it">www.emu.it</a> | 600/03 |   |
|  | 600/10 |   |
|  | 600/11 |   |
|  | 600/12 |   |
|  | 600/22 |   |

### CON TESSUTO CLIENTE—WITH CUSTOMER'S FABRIC

FABBISOGNO TESSUTO (cm)—FABRIC REQUIRED (cm) C/421 132x90, C/422 132x230

ⓧ La caratteristica FLAME RETARDANT indica una capacità di resistenza contro fonti di calore o fuoco.  
Per conoscere nel dettaglio tale caratteristica si prega di far riferimento alle schede tecniche presenti nell'area riservata del sito [www.emu.it](http://www.emu.it)  
The FLAME RETARDANT characteristic is an indication of chemical resistance against sources of heat or fire.  
To find out more about this feature, please refer to the technical data sheets in the reserved area of the website [www.emu.it](http://www.emu.it)





Scansiona e scopri i progetti.  
Scan and discover the projects.



744

Poltrona

Lounge chair

W103 - D83 - H72



\* Cuscino visibile in foto 900/02 Mare—Cushion in the picture 900/02 Sea

745

Pouf

Pouf

W78 - D68 - H42

C/745



\* Cuscino visibile in foto 900/02 Mare—Cushion in the picture 900/02 Sea

## COMBINAZIONI CONSIGLIATE—SUGGESTED MATCHINGS

218



YARD  
Cod. 507  
Tavolo basso  
Coffee table  
PAG. 264



YARD  
Cod. 509  
Tavolo basso  
Coffee table  
PAG. 264



Possibilità di personalizzazione dei cuscini schienali che, nelle loro diverse altezze, possono creare diverse geometrie di arredo secondo il proprio gusto e le proprie esigenze.  
Possibility to customize the backrest cushions that, in their different heights, can create different furniture geometries according to your taste and your needs.

742

Divano 2 posti  
schienale basso

Short back 2-seater sofa  
W195 - D91 - H72

C/751+C/752+2xC/756+4  
x742/S



743

Divano 3 posti  
schienale alto

Tall back 3-seater sofa  
W289 - D91 - H84

C/753+C/754+C/757+C/760+  
2xC/756+5x742/S

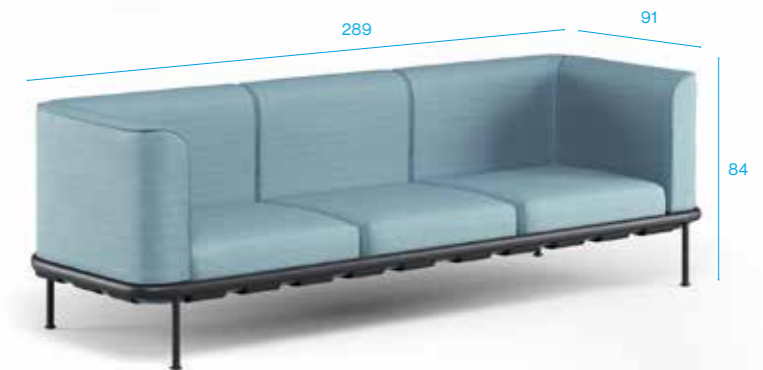

742

Divano 2 posti con isola  
schienale alto

Tall back 2-seater sofa  
with island  
W195 - D91 - H84

C/753+C/756+C/758+2x742/S



743

Divano 3 posti con isola  
schienale alto

Tall back 3-seater sofa  
with island  
W289 - D91 - H84

C/753+C/756+C/757+C/758+  
C/760+3x742/S



\* Cuscino visibile in foto 900/02 Mare—Cushion in the picture 900/02 Sea

## PLUS

- **Leggerezza:** struttura in tubolare e lamiera in alluminio.  
Tubular frame and aluminium sheet that give the product both lightness and solidity.
- **Praticità** nel fissaggio del cuscino schienale che viene incalzato sul supporto schienale e fissato tramite un pratico sistema in velcro.—Practicality fastening backrest cushion that is pressed on the backrest support and fixed by a practical Velcro system.
- **Cuscini sfoderabili e personalizzabili** con un'ampia gamma di tessuti.  
Cushions are cover removable and customizable with a wide fabric range.

219

# PRODOTTI—PRODUCTS

| Codice/Code<br>Tipologia/Typology  | Disegno/Drawing | Info | TEST              |
|--|-----------------|------|-------------------|
| <b>744</b><br>Poltrona—Lounge chair<br>W103 - D83 - H72<br>Kg 16,6                           |                 |      | EN581-1 / EN581-2 |
| <b>742</b><br>Struttura divano 2 posti<br>2-seater sofa frame<br>W195 - D91 - H32<br>Kg 17,7 |                 |      | EN581-1 / EN581-2 |
| <b>743</b><br>Struttura divano 3 posti<br>3-seater sofa frame<br>W289 - D91 - H32<br>Kg 25,4 |                 |      | EN581-1 / EN581-2 |
| <b>745</b><br>Pouf—Pouf<br>W78 - D68 - H32<br>Kg 6,8   |                 |      |                   |

## COLORI STRUTTURA—FRAME COLORS

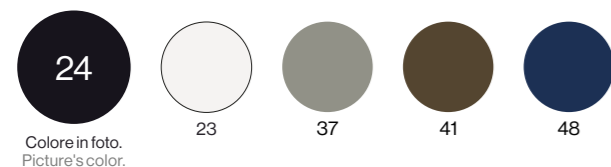

# CUSCINI—CUSHIONS

| Codice/Code<br>Tipologia/Typology  | Colori<br>Colors                | Categoria tessuto<br>Fabric category  |
|--|---------------------------------|---|
| <b>742/S</b><br>Kit n. 3 supporti cuscini<br>Cushions supports (n. 3) kit<br>x cod. C/751, C/752, C/753, C/754, C/759, C/760<br>Kg 2,1 | 23<br>24<br>37<br>41<br>48      |   |
| <b>C/701</b><br>Cuscino decorativo—Decorative cushion<br>x cod. 742, 743, 744<br>W40 - D40 - H15 Kg 0,7                                |                                 | Tessuti Basic (Vedi riepilogo pg. 325)<br>Tessuti Standard (Vedi riepilogo pg. 325)<br>Tessuti Premium (Vedi riepilogo pg. 325)<br>Basic Fabrics (Look at pg. 325)<br>Standard Fabrics (Look at pg. 325)<br>Premium Fabrics (Look at pg. 325) |
| <b>C/705</b><br>Cuscino decorativo—Decorative cushion<br>x cod. 742, 743, 744<br>W45 - D35 - H15 Kg 0,6                                | Vedi pg. 325<br>Look at pg. 325 |   |
| <b>C/706</b><br>Cuscino decorativo—Decorative cushion<br>x cod. 742, 743, 744<br>W60 - D40 - H20 Kg 0,8                                |                                 |   |

# CUSCINI—CUSHIONS



| Codice/Code<br>Tipologia/Typology  | Colori tessuto<br>Fabric colors                                    | Categoria tessuto<br>Fabric category |
|--|--|--------------------------------------|
| <b>C/751</b><br>Cuscino angolo dx basso—Short right corner cushion<br>x cod. 742, 743<br>W97+83 - D49 - H18 Kg 4,1 | 900/02<br>900/03<br>900/05<br>900/07<br>900/71<br>900/75<br>900/77 | Tessuti Standard<br>Standard Fabrics |
| <b>C/752</b><br>Cuscino angolo sx basso—Short left corner cushion<br>x cod. 742, 743<br>W97+83 - D49 - H18 Kg 4,1  | 900/02<br>900/03<br>900/05<br>900/07<br>900/71<br>900/75<br>900/77 |                                      |
| <b>C/753</b><br>Cuscino angolo dx alto—Tall right corner cushion<br>x cod. 742, 743<br>W97+83 - D62 - H18 Kg 5,0   | 900/02<br>900/03<br>900/05<br>900/07<br>900/71<br>900/75<br>900/77 |                                      |
| <b>C/754</b><br>Cuscino angolo sx alto—Tall left corner cushion<br>x cod. 742, 743<br>W97+83 - D62 - H18 Kg 5,0    | 900/02<br>900/03<br>900/05<br>900/07<br>900/71<br>900/75<br>900/77 |                                      |
| <b>C/756</b><br>Cuscino seduta angolare—Corner seat cushion<br>x cod. 742, 743<br>W75 - D63 - H20 Kg 2,8           | 900/02<br>900/03<br>900/05<br>900/07<br>900/71<br>900/75<br>900/77 |                                      |
| <b>C/757</b><br>Cuscino seduta—Seat cushion<br>x cod. 742, 743<br>W94 - D63 - H20 Kg 3,5                           | 900/02<br>900/03<br>900/05<br>900/07<br>900/71<br>900/75<br>900/77 |                                      |
| <b>C/758</b><br>Cuscino seduta isola—Island seat cushion<br>x cod. 742, 743<br>W94 - D83 - H20 Kg 4,1              | 900/02<br>900/03<br>900/05<br>900/07<br>900/71<br>900/75<br>900/77 |                                      |
| <b>C/759</b><br>Cuscino schienale basso—Short back cushion<br>x cod. 742, 743<br>W94 - D49 - H18 Kg 2,5            | 900/02<br>900/03<br>900/05<br>900/07<br>900/71<br>900/75<br>900/77 |                                      |
| <b>C/760</b><br>Cuscino schienale alto—Tall back cushion<br>x cod. 742, 743<br>W94 - D62 - H18 Kg 3,2              | 900/02<br>900/03<br>900/05<br>900/07<br>900/71<br>900/75<br>900/77 |                                      |
| <b>C/745</b><br>Cuscino seduta—Seat cushion<br>x cod. 745<br>W70 - D59 - H20 Kg 2,3                                | 900/02<br>900/03<br>900/05<br>900/07<br>900/71<br>900/75<br>900/77 |                                      |
| <b>FC/742</b> Cover x cod. 742   |  |                                      |
| <b>FC/743</b> Cover x cod. 743   |  |                                      |
| <b>FC/744</b> Cover x cod. 744   |  |                                      |
| <b>FC/745</b> Cover x cod. 745   |  |                                      |





Scansiona e scopri i progetti.  
Scan and discover the projects.

585+C/585  
Poltrona  
Lounge chair



La lamiera stirata prezinata viene saldata a proiezione ai toncini perimetrali e successivamente cataforizzata. The pre hot-dip zincated expanded sheet is spot welded and cataphorised later on.

586  
Divano  
Sofa



Tale tipologia di lamiera, esclusiva per la collezione Ivy, viene modellata tramite stampo per conferire ergonomia alle sedute. This type of sheet is exclusively used for the Ivy collection. It is moulded to make the seating collection extremely ergonomic.

PRODOTTI—PRODUCTS



| Codice/Code<br>Tipologia/Typology                        | Disegno/Drawing | Info |
|--|-----------------|------|
| 585<br>Poltrona—Lounge chair<br>W110 - D90 - H66 Kg 16,2 |                 |      |
| 586<br>Divano—Sofa<br>W192 - D90 - H66 Kg 25,2           |                 |      |

COLORI STRUTTURA—FRAME COLORS



Colore in foto.  
Picture's color.

CUSCINI—CUSHIONS

| Codice/Code<br>Tipologia/Typology  | Colori tessuto<br>Fabric colors | Categoria tessuto<br>Fabric category   |
|--|---------------------------------|--|
| C/585<br>Cuscino seduta e schienale polipropilene<br>Polyporpylene seat and back cushion<br>x cod. 585<br>W70 - D64 - H5 Kg 1,1  |                                 | 900/71*<br>Tessuti Standard<br>Standard Fabrics  |
| C/586<br>Cuscino seduta e schienale polipropilene<br>Polyporpylene seat and back cushion<br>x cod. 586<br>W70 - D148 - H5 Kg 3,6 |                                 | 900/71<br>Tessuti Standard<br>Standard Fabrics   |
| C/701<br>Cuscino decorativo—Decorative cushion<br>x cod. 585, 586<br>W40 - D40 - H15 Kg 0,7                                      |                                 | Vedi pg. 325<br>Look at pg. 325<br>Tessuti Basic (Vedi riepilogo pg. 325)<br>Tessuti Standard (Vedi riepilogo pg. 325)<br>Tessuti Premium (Vedi riepilogo pg. 325)<br>Basic Fabrics (Look at pg. 325)<br>Standard Fabrics (Look at pg. 325)<br>Premium Fabrics (Look at pg. 325) |
| C/705<br>Cuscino decorativo—Decorative cushion<br>x cod. 585, 586<br>W45 - D35 - H15 Kg 0,6                                      |                                 |  |
| C/706<br>Cuscino decorativo—Decorative cushion<br>x cod. 585, 586<br>W60 - D40 - H20 Kg 0,8                                      |                                 |  |

\* Cuscino visibile in foto—Cushion in the picture

ALTRI PRODOTTI IN COLLEZIONE—OTHER COLLECTION'S PRODUCTS



IVY  
Cod. 589  
Tavolo basso  
Coffee table  
PAG. 254

# TAMI (Bamboo slats)

Design by Patrick Norguet



Scansiona e scopri i progetti.  
Scan and discover the projects.



## 763+2x761+762

Poltrona  
Lounge chair  
W132 - D86 - H84

C/770+C/771+2x C/772



Struttura in profilati di alluminio.  
Frame in aluminium profiles.

\* Cuscino visibile in foto 900/77 Grigio trama stretta—Cushion in the picture 900/77 Small weft grey

## 764+2x761+2x762

Divano 2 posti  
2-seater sofa  
W205 - D86 - H84

2x C/770+2x C/771+2x C/772



Giunti in pressofusione di alluminio per una migliore ricercatezza estetica.  
Aluminium die-cast joints for a better aesthetic refinement.

\* Cuscino visibile in foto 900/77 Grigio trama stretta—Cushion in the picture 900/77 Small weft grey

## 765+2x761+3x762

Divano 3 posti  
3-seater sofa  
W277 - D86 - H84

3x C/770+3x C/771+2x C/772



Doghe in bambù per un piacevole effetto tattile e visivo.  
Slats made of bamboo for a pleasant touch, look and feel.

\* Cuscino visibile in foto 900/77 Grigio trama stretta—Cushion in the picture 900/77 Small weft grey

## 763+764+769+2x761+4x762

Divano angolare 4 posti  
4-seater corner sofa  
W338 - D265 - H84

4x C/770+4x C/771+2x C/772



\* Cuscino visibile in foto 900/77 Grigio trama stretta—Cushion in the picture 900/77 Small weft grey



Cuscini seduta antiscivolo con sistema di fissaggio tramite laccetti che si assicurano alla struttura dello schienale con pratici ganci.  
Non-slip seat cushions with laces/hooks system fastened to the backrest frame.

## PLUS

- Ampia possibilità di personalizzazione tramite posizionamento dei cuscini e dei moduli.  
Wide range of customizable position of cushions and modules.
- Cuscini sfoderabili e personalizzabili con un'ampia gamma di tessuti.  
Cushions are cover removable and customizable with a wide fabric range.
- Tavolo orientabile disponibile come accessorio.—Free standing table available as accessory.



**763+2x761+762**

Poltrona  
Lounge chair  
W132 - D86 - H84

C/770+C/771+2x C/772



Struttura in profilati di alluminio.  
Frame in aluminium profiles.

\* Cuscino visibile in foto 900/77 Grigio trama stretta—Cushion in the picture 900/77 Small weft grey

**764+2x761+2x762**

Divano 2 posti  
2-seater sofa  
W205 - D86 - H84

2x C/770+2x C/771+2x C/772



Giunti in pressofusione di  
alluminio per una migliore  
ricercatezza estetica.  
Aluminium die-cast joints for  
a better aesthetic refinement.

\* Cuscino visibile in foto 900/77 Grigio trama stretta—Cushion in the picture 900/77 Small weft grey

**765+2x761+3x762**

Divano 3 posti  
3-seater sofa  
W277 - D86 - H84

3x C/770+3x C/771+2x C/772



Doghe in WPC, materiale  
composito estremamente  
resistente.  
Slats made of WPC, an extremely  
resistant composite material.

\* Cuscino visibile in foto 900/77 Grigio trama stretta—Cushion in the picture 900/77 Small weft grey

**763+764+769+2x761+4x762**

Divano angolare 4 posti  
4-seater corner sofa  
W338 - D265 - H84

4x C/770+4x C/771+2x C/772



\* Cuscino visibile in foto 900/77 Grigio trama stretta—Cushion in the picture 900/77 Small weft grey



Cuscini seduta antiscivolo con sistema di fissaggio tramite laccetti  
che si assicurano alla struttura dello schienale con pratici ganci.  
Non-slip seat cushions with laces/hooks system fastened to the backrest frame.

# PRODOTTI—PRODUCTS

| Codice/Code<br>Tipologia/Typology   | Disegno/Drawing | Info | TEST  |    |        |    |        |    |        |    |        |    |        |    |        |    |        |    |        |    |        |    |        |    |        |    |        |    |        |    |        |    |        |    |        |    |  |    |  |
|---|-----------------|------|---|----|--------|----|--------|----|--------|----|--------|----|--------|----|--------|----|--------|----|--------|----|--------|----|--------|----|--------|----|--------|----|--------|----|--------|----|--------|----|--------|----|--|----|--|
| <b>763</b><br>Struttura poltrona<br>Lounge chair frame<br>W132 - D86 - H25<br>Kg 35,6/42,3        |                 |      |   |    |        |    |        |    |        |    |        |    |        |    |        |    |        |    |        |    |        |    |        |    |        |    |        |    |        |    |        |    |        |    |        |    |  |    |  |
| <b>764</b><br>Struttura divano 2 posti<br>2-seater sofa frame<br>W205 - D86 - H25<br>Kg 50,0/60,4 |                 |      |   |    |        |    |        |    |        |    |        |    |        |    |        |    |        |    |        |    |        |    |        |    |        |    |        |    |        |    |        |    |        |    |        |    |  |    |  |
| <b>765</b><br>Struttura divano 3 posti<br>3-seater sofa frame<br>W277 - D86 - H25<br>Kg 64,0/78,0 |                 |      | EN581-1/EN581-2   |    |        |    |        |    |        |    |        |    |        |    |        |    |        |    |        |    |        |    |        |    |        |    |        |    |        |    |        |    |        |    |        |    |  |    |  |
| <b>769</b><br>Struttura angolare<br>Angular frame<br>W194 - D86 - H25<br>Kg 32,1/35,6             |                 |      |   |    |        |    |        |    |        |    |        |    |        |    |        |    |        |    |        |    |        |    |        |    |        |    |        |    |        |    |        |    |        |    |        |    |  |    |  |
| <b>761</b><br>Telaio bracciolo<br>Armrest frame<br>W65 - D5 - H35<br>Kg 1,2                       |                 |      | <table border="1"> <tr><td>23</td><td>900/71</td></tr> <tr><td>23</td><td>900/75</td></tr> <tr><td>23</td><td>900/77</td></tr> <tr><td>23</td><td>900/79</td></tr> <tr><td>24</td><td>900/71</td></tr> <tr><td>24</td><td>900/75</td></tr> <tr><td>24</td><td>900/77</td></tr> <tr><td>24</td><td>900/79</td></tr> <tr><td>23</td><td>900/71</td></tr> <tr><td>23</td><td>900/75</td></tr> <tr><td>23</td><td>900/77</td></tr> <tr><td>23</td><td>900/79</td></tr> <tr><td>24</td><td>900/71</td></tr> <tr><td>24</td><td>900/75</td></tr> <tr><td>24</td><td>900/77</td></tr> <tr><td>24</td><td>900/79</td></tr> <tr><td>23</td><td></td></tr> <tr><td>24</td><td></td></tr> </table> | 23 | 900/71 | 23 | 900/75 | 23 | 900/77 | 23 | 900/79 | 24 | 900/71 | 24 | 900/75 | 24 | 900/77 | 24 | 900/79 | 23 | 900/71 | 23 | 900/75 | 23 | 900/77 | 23 | 900/79 | 24 | 900/71 | 24 | 900/75 | 24 | 900/77 | 24 | 900/79 | 23 |  | 24 |  |
| 23  | 900/71          |      |   |    |        |    |        |    |        |    |        |    |        |    |        |    |        |    |        |    |        |    |        |    |        |    |        |    |        |    |        |    |        |    |        |    |  |    |  |
| 23  | 900/75          |      |   |    |        |    |        |    |        |    |        |    |        |    |        |    |        |    |        |    |        |    |        |    |        |    |        |    |        |    |        |    |        |    |        |    |  |    |  |
| 23  | 900/77          |      |   |    |        |    |        |    |        |    |        |    |        |    |        |    |        |    |        |    |        |    |        |    |        |    |        |    |        |    |        |    |        |    |        |    |  |    |  |
| 23  | 900/79          |      |   |    |        |    |        |    |        |    |        |    |        |    |        |    |        |    |        |    |        |    |        |    |        |    |        |    |        |    |        |    |        |    |        |    |  |    |  |
| 24  | 900/71          |      |   |    |        |    |        |    |        |    |        |    |        |    |        |    |        |    |        |    |        |    |        |    |        |    |        |    |        |    |        |    |        |    |        |    |  |    |  |
| 24  | 900/75          |      |   |    |        |    |        |    |        |    |        |    |        |    |        |    |        |    |        |    |        |    |        |    |        |    |        |    |        |    |        |    |        |    |        |    |  |    |  |
| 24  | 900/77          |      |   |    |        |    |        |    |        |    |        |    |        |    |        |    |        |    |        |    |        |    |        |    |        |    |        |    |        |    |        |    |        |    |        |    |  |    |  |
| 24  | 900/79          |      |   |    |        |    |        |    |        |    |        |    |        |    |        |    |        |    |        |    |        |    |        |    |        |    |        |    |        |    |        |    |        |    |        |    |  |    |  |
| 23  | 900/71          |      |   |    |        |    |        |    |        |    |        |    |        |    |        |    |        |    |        |    |        |    |        |    |        |    |        |    |        |    |        |    |        |    |        |    |  |    |  |
| 23  | 900/75          |      |   |    |        |    |        |    |        |    |        |    |        |    |        |    |        |    |        |    |        |    |        |    |        |    |        |    |        |    |        |    |        |    |        |    |  |    |  |
| 23  | 900/77          |      |   |    |        |    |        |    |        |    |        |    |        |    |        |    |        |    |        |    |        |    |        |    |        |    |        |    |        |    |        |    |        |    |        |    |  |    |  |
| 23  | 900/79          |      |   |    |        |    |        |    |        |    |        |    |        |    |        |    |        |    |        |    |        |    |        |    |        |    |        |    |        |    |        |    |        |    |        |    |  |    |  |
| 24  | 900/71          |      |   |    |        |    |        |    |        |    |        |    |        |    |        |    |        |    |        |    |        |    |        |    |        |    |        |    |        |    |        |    |        |    |        |    |  |    |  |
| 24  | 900/75          |      |   |    |        |    |        |    |        |    |        |    |        |    |        |    |        |    |        |    |        |    |        |    |        |    |        |    |        |    |        |    |        |    |        |    |  |    |  |
| 24  | 900/77          |      |   |    |        |    |        |    |        |    |        |    |        |    |        |    |        |    |        |    |        |    |        |    |        |    |        |    |        |    |        |    |        |    |        |    |  |    |  |
| 24  | 900/79          |      |   |    |        |    |        |    |        |    |        |    |        |    |        |    |        |    |        |    |        |    |        |    |        |    |        |    |        |    |        |    |        |    |        |    |  |    |  |
| 23  |                 |      |   |    |        |    |        |    |        |    |        |    |        |    |        |    |        |    |        |    |        |    |        |    |        |    |        |    |        |    |        |    |        |    |        |    |  |    |  |
| 24  |                 |      |   |    |        |    |        |    |        |    |        |    |        |    |        |    |        |    |        |    |        |    |        |    |        |    |        |    |        |    |        |    |        |    |        |    |  |    |  |
| <b>762</b><br>Telaio schienale<br>Backrest frame<br>W68 - D5 - H49<br>Kg 1,6                      |                 |      |   |    |        |    |        |    |        |    |        |    |        |    |        |    |        |    |        |    |        |    |        |    |        |    |        |    |        |    |        |    |        |    |        |    |  |    |  |
| <b>768</b><br>Tavolino orientabile<br>Free standing table<br>W50 - D35 - H40<br>Kg 2,1            |                 |      |   |    |        |    |        |    |        |    |        |    |        |    |        |    |        |    |        |    |        |    |        |    |        |    |        |    |        |    |        |    |        |    |        |    |  |    |  |

COLORI STRUTTURA/DOGHE X COD. 763, 764, 765—FRAME/SLATS COLORS X COD. 763, 764, 765

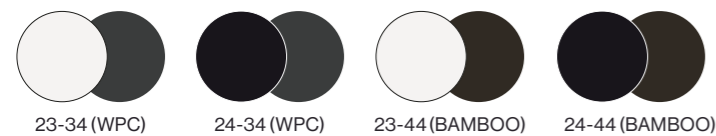

COLORI STRUTTURA/DOGHE/PIANO IN GRES X COD. 769—FRAME/SLATS/GRES TOP COLORS X COD. 769

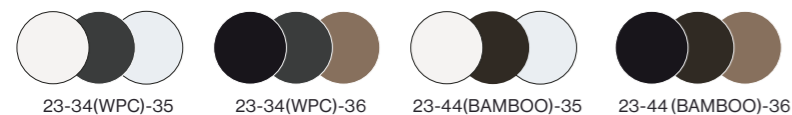

ALTRI PRODOTTI IN COLLEZIONE—OTHER COLLECTION'S PRODUCTS



# CUSCINI—CUSHIONS



| Codice/Code<br>Tipologia/Typology  | Colori tessuto<br>Fabric colors | Categoria tessuto<br>Fabric category |
|--|---------------------------------|--------------------------------------|
| <b>C/770</b><br>Cuscino seduta—Seat cushion<br>x cod. 763, 764, 765, 769<br>W69 - D69 - H19 Kg 2,3           |                                 | Vedi pg. 230<br>Look at pg. 230      |
| <b>C/771</b><br>Cuscino schienale—Back cushion<br>x cod. 763, 764, 765, 769<br>W69 - D43 - H19 Kg 2,2        |                                 |                                      |
| <b>C/772</b><br>Cuscino bracciolo—Armrest cushion<br>x cod. 763, 764, 765<br>W67 - D40 - H16 Kg 1,6          |                                 |                                      |
| <b>C/773</b><br>Cuscino decorativo—Decorative cushion<br>x cod. 763, 764, 765, 769<br>W55 - D24 - H13 Kg 0,7 |                                 |                                      |
| <b>C/701</b><br>Cuscino decorativo—Decorative cushion<br>x cod. 763, 764, 765, 769<br>W40 - D40 - H15 Kg 0,7 |                                 | Vedi pg. 325<br>Look at pg. 325      |
| <b>C/705</b><br>Cuscino decorativo—Decorative cushion<br>x cod. 763, 764, 765, 769<br>W45 - D35 - H15 Kg 0,6 |                                 |                                      |
| <b>C/706</b><br>Cuscino decorativo—Decorative cushion<br>x cod. 763, 764, 765, 769<br>W60 - D40 - H20 Kg 0,8 |                                 |                                      |
| <b>FC/743</b> Cover x cod. 765   |                                 |                                      |
| <b>FC/763</b> Cover x cod. 763   |                                 |                                      |
| <b>FC/764</b> Cover x cod. 764   |                                 |                                      |



## TESSUTI CUSCINI—CUSHION FABRICS C/770 - C/771 - C/772 - C/773

Composizione/Categoria tessuti  
Composition/Fabrics category

Colori  
Colors

### TESSUTI BASIC—BASIC FABRICS

|                  |        |
|------------------|--------|
| Acrilico—Acrylic | 700/4  |
|                  | 700/10 |
|                  | 700/12 |
|                  | 700/13 |
|                  | 700/14 |

### TESSUTI STANDARD—STANDARD FABRICS

|  |        |
|--|--------|
| 85% Polipropilene, 15% Poliestere—85% Polypropylene, 15% Polyester | 900/01 |
|  | 900/02 |
|  | 900/03 |
|  | 900/05 |
|  | 900/06 |
|  | 900/07 |
|  | 900/08 |
|  | 900/09 |
|  | 900/13 |
|  | 900/14 |
|  | 900/17 |
|  | 900/18 |
|  | 900/71 |
|  | 900/75 |
| 900/77   |        |
| 900/79   |        |

### TESSUTI PREMIUM—PREMIUM FABRICS

|  |        |   |
|--|--------|---|
| CAT. D<br>Visitare il nostro sito web <a href="http://www.emu.it">www.emu.it</a> —Visit our website <a href="http://www.emu.it">www.emu.it</a> | 600/08 | Ⓢ |
|  | 600/09 | Ⓢ |
|  | 600/15 | Ⓢ |
|  | 600/17 | Ⓢ |
|  | 600/24 | Ⓢ |
| CAT. C<br>Visitare il nostro sito web <a href="http://www.emu.it">www.emu.it</a> —Visit our website <a href="http://www.emu.it">www.emu.it</a> | 600/26 | Ⓢ |
|  | 600/27 | Ⓢ |
|  | 600/28 | Ⓢ |
|  | 900/16 | Ⓢ |
|  | 900/19 | Ⓢ |
| CAT. B<br>Visitare il nostro sito web <a href="http://www.emu.it">www.emu.it</a> —Visit our website <a href="http://www.emu.it">www.emu.it</a> | 600/02 | Ⓢ |
|  | 600/07 | Ⓢ |
|  | 600/14 | Ⓢ |
|  | 600/16 | Ⓢ |
|  | 600/18 | Ⓢ |
| CAT. A<br>Visitare il nostro sito web <a href="http://www.emu.it">www.emu.it</a> —Visit our website <a href="http://www.emu.it">www.emu.it</a> | 600/03 | Ⓢ |
|  | 600/10 | Ⓢ |
|  | 600/11 | Ⓢ |
|  | 600/12 | Ⓢ |
|  | 600/22 | Ⓢ |
| 600/04   | Ⓢ      |   |
| 600/06   | Ⓢ      |   |
| 600/21   | Ⓢ      |   |

### CON TESSUTO CLIENTE—WITH CUSTOMER'S FABRIC

FABBISOGNO TESSUTO (cm)—FABRIC REQUIRED (cm) C/770 132x120, C/771 132x120, C/772 132x100, C/773 132x60

Ⓢ La caratteristica FLAME RETARDANT indica una capacità di resistenza contro fonti di calore o fuoco.  
Per conoscere nel dettaglio tale caratteristica si prega di far riferimento alle schede tecniche presenti nell'area riservata del sito [www.emu.it](http://www.emu.it)  
The FLAME RETARDANT characteristic is an indication of chemical resistance against sources of heat or fire.  
To find out more about this feature, please refer to the technical data sheets in the reserved area of the website [www.emu.it](http://www.emu.it)

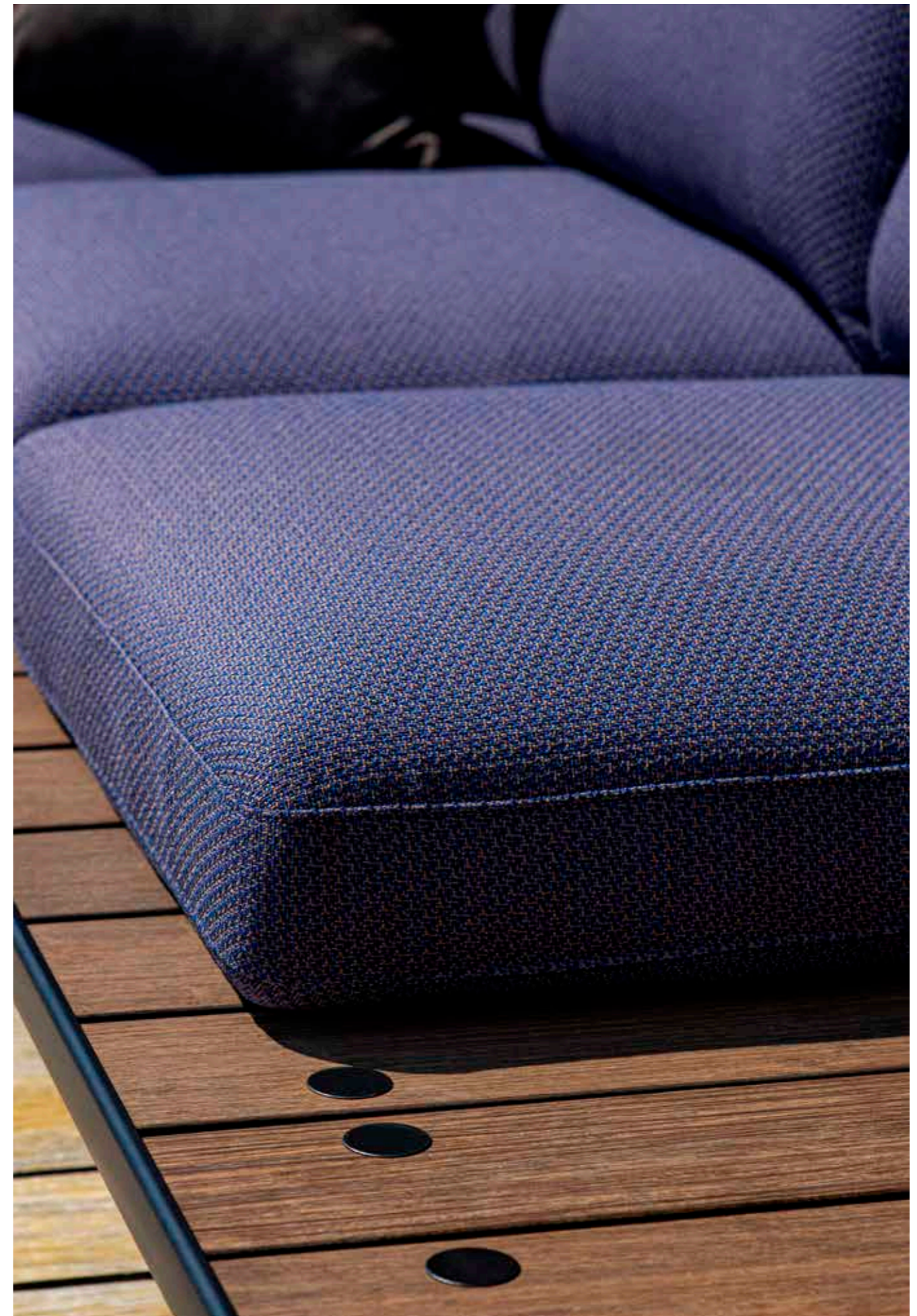



Scansiona e scopri i progetti.  
Scan and discover the projects.



## 729+C/729 Poltrona Lounge chair



I cuscini dello schienale hanno piccole asole per il fissaggio ai perni in acciaio inossidabile presenti sulla struttura.  
Backrest cushions have small holes to be fastened to the stainless-steel button on the frame.

\* Cuscino visibile in foto 900/07 Avana—Cushion in the picture 900/07 Chesnut

## 730+2xC/729 Divano 2 posti 2-seater sofa

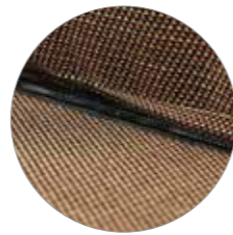

Grande comfort e funzione antiscivolo dei cuscini garantiti dalla pratica zip che unisce sedile e schienale.  
Great comfort and non-slip feature of the cushions thanks to the handy zip between seat and backrest.

\* Cuscino visibile in foto 900/07 Avana—Cushion in the picture 900/07 Chesnut

## 731+3xC/729 Divano 3 posti 3-seater sofa



Struttura in profili di alluminio. Schienale e braccioli in ecopelle per esterni.  
Frame in aluminium profiles. Backrest and armrests in eco-leather for outdoor use.

\* Cuscino visibile in foto 900/07 Avana—Cushion in the picture 900/07 Chesnut

### ALTRI PRODOTTI IN COLLEZIONE—OTHER COLLECTION'S PRODUCTS



TERRAMARE  
Cod. 732+735P  
Tavolo basso piccolo  
Small coffee table  
PAG. 262



TERRAMARE  
Cod. 733+736P  
Tavolo basso medio  
Medium coffee table  
PAG. 262



TERRAMARE  
Cod. 726  
Tavolo smart  
Smart table  
PAG. 200

## PRODOTTI—PRODUCTS

| Codice/Code<br>Tipologia/Typology  | Disegno/Drawing | Info | TEST             |
|--|-----------------|------|------------------|
| 729<br>Struttura poltrona<br>Lounge chair frame<br>W94 - D86 - H72 Kg 13,6           |                 |      | EN581-1/ EN581-2 |
| 730<br>Struttura divano a 2 posti<br>2-seater sofa frame<br>W175 - D86 - H72 Kg 18,5 |                 |      | EN581-1/ EN581-2 |
| 731<br>Struttura divano a 3 posti<br>3-seater sofa frame<br>W257 - 86 - H72 Kg 24,1  |                 |      | EN581-1/ EN581-2 |

### COLORI STRUTTURA/BRACCIOLI—FRAME/ARMRESTS COLORS



## CUSCINI—CUSHIONS

| Codice/Code<br>Tipologia/Typology   | Colori tessuto<br>Fabric colors | Categoria tessuto<br>Fabric category   |
|---|---------------------------------|--|
| C/729<br>Cuscino seduta e schienale<br>Seat and back cushion<br>x cod.729, 730, 731<br>W95 - D95 - H25 W90 - D50 - H25 Kg 6,5 |                                 | Vedi pg. 234<br>Look at pg. 234<br>Tessuti Basic (Vedi riepilogo pg. 234)<br>Tessuti Standard (Vedi riepilogo pg. 234)<br>Tessuti Premium (Vedi riepilogo pg. 234)<br>Basic Fabrics (Look at pg. 234)<br>Standard Fabrics (Look at pg. 234)<br>Premium Fabrics (Look at pg. 234) |
| C/701<br>Cuscino decorativo—Decorative cushion<br>x cod.729, 730, 731<br>W40 - D40 - H15 Kg 0,7                               |                                 | Vedi pg. 325<br>Look at pg. 325<br>Tessuti Basic (Vedi riepilogo pg. 325)<br>Tessuti Standard (Vedi riepilogo pg. 325)<br>Tessuti Premium (Vedi riepilogo pg. 325)<br>Basic Fabrics (Look at pg. 325)<br>Standard Fabrics (Look at pg. 325)<br>Premium Fabrics (Look at pg. 325) |
| C/705<br>Cuscino decorativo—Decorative cushion<br>x cod.729, 730, 731<br>W45 - D35 - H15 Kg 0,6                               |                                 |  |
| C/706<br>Cuscino decorativo—Decorative cushion<br>x cod.729, 730, 731<br>W60 - D40 - H20 Kg 0,8                               |                                 |  |
| FC/729 Cover x cod. 729   |                                 |  |
| FC/730 Cover x cod. 730   |                                 |  |
| FC/731 Cover x cod. 731   |                                 |  |

## PLUS

- Giunti in pressofusione di alluminio di grande finitura e ricercatezza estetica.  
Elegant finishing and aesthetic refinement of die-cast aluminium joints.
- Elevato comfort del cuscino grazie alla doppia composizione dell'imbottitura in poliuretano e fiocchi in poliestere.  
Great comfort of the cushions due to double padding made up of polyurethane and polyester flakes.
- Fodera interna dei cuscini impermeabile per un migliore drenaggio dell'acqua.  
Water-proof inner lining of the cushions for a better water drainage.



## TESSUTI CUSCINI—CUSHION FABRICS C/729

Composizione/Categoria tessuti  
Composition/Fabrics category

Colori  
Colors

### TESSUTI BASIC—BASIC FABRICS

|                  |        |
|------------------|--------|
| Acrilico—Acrylic | 700/4  |
|                  | 700/10 |
|                  | 700/12 |
|                  | 700/13 |
|                  | 700/14 |

### TESSUTI STANDARD—STANDARD FABRICS

|  |        |
|--|--------|
| 85% Polipropilene, 15% Poliestere—85% Polypropylene, 15% Polyester | 900/01 |
|  | 900/02 |
|  | 900/03 |
|  | 900/05 |
|  | 900/06 |
|  | 900/07 |
|  | 900/08 |
|  | 900/09 |
|  | 900/13 |
|  | 900/14 |
|  | 900/17 |
|  | 900/18 |
|  | 900/71 |
|  | 900/75 |
| 900/77   |        |
| 900/79   |        |

### TESSUTI PREMIUM—PREMIUM FABRICS

|  |        |   |
|--|--------|---|
| CAT. D<br>Visitare il nostro sito web <a href="http://www.emu.it">www.emu.it</a> —Visit our website <a href="http://www.emu.it">www.emu.it</a> | 600/08 | Ⓢ |
|  | 600/09 | Ⓢ |
|  | 600/15 | Ⓢ |
|  | 600/17 | Ⓢ |
|  | 600/24 | Ⓢ |
| CAT. C<br>Visitare il nostro sito web <a href="http://www.emu.it">www.emu.it</a> —Visit our website <a href="http://www.emu.it">www.emu.it</a> | 600/26 | Ⓢ |
|  | 600/27 | Ⓢ |
|  | 600/28 | Ⓢ |
|  | 900/16 | Ⓢ |
|  | 900/19 | Ⓢ |
| CAT. B<br>Visitare il nostro sito web <a href="http://www.emu.it">www.emu.it</a> —Visit our website <a href="http://www.emu.it">www.emu.it</a> | 600/02 | Ⓢ |
|  | 600/07 | Ⓢ |
|  | 600/14 | Ⓢ |
|  | 600/16 | Ⓢ |
|  | 600/18 | Ⓢ |
| CAT. A<br>Visitare il nostro sito web <a href="http://www.emu.it">www.emu.it</a> —Visit our website <a href="http://www.emu.it">www.emu.it</a> | 600/03 | Ⓢ |
|  | 600/10 | Ⓢ |
|  | 600/11 | Ⓢ |
|  | 600/12 | Ⓢ |
|  | 600/22 | Ⓢ |

### CON TESSUTO CLIENTE—WITH CUSTOMER'S FABRIC

FABBISOGNO TESSUTO (cm)—FABRIC REQUIRED (cm)

C/729 132x360

Ⓢ La caratteristica FLAME RETARDANT indica una capacità di resistenza contro fonti di calore o fuoco.  
Per conoscere nel dettaglio tale caratteristica si prega di far riferimento alle schede tecniche presenti nell'area riservata del sito [www.emu.it](http://www.emu.it)  
The FLAME RETARDANT characteristic is an indication of chemical resistance against sources of heat or fire.  
To find out more about this feature, please refer to the technical data sheets in the reserved area of the website [www.emu.it](http://www.emu.it)

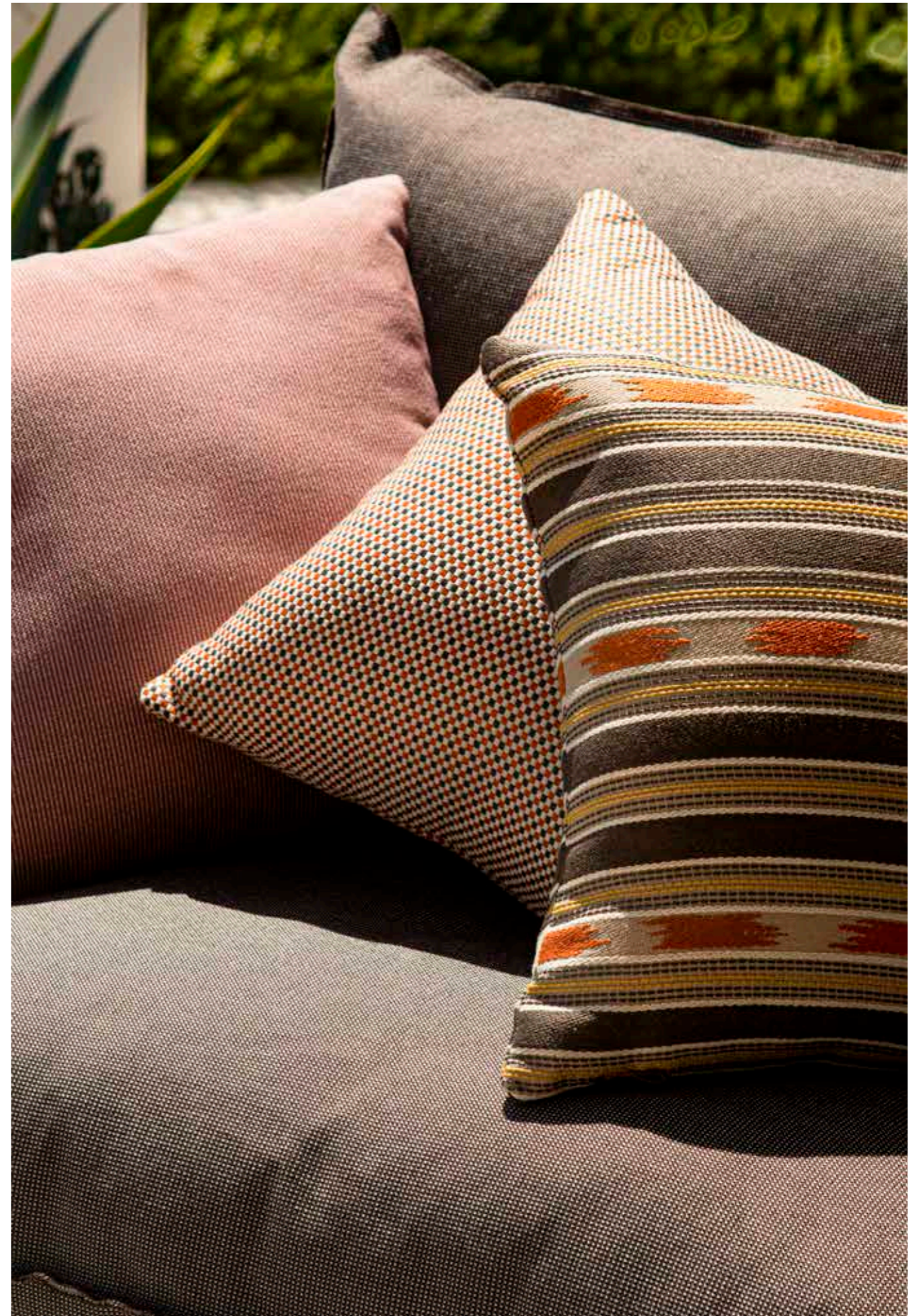

# DIVANI NELLE ALTRE COLLEZIONI

## SOFAS IN THE OTHER COLLECTIONS

### ATHENA

Design by EMU

3417

Divano 2 posti

2-seater sofa

PAG. 26



### SHINE

Design by Arik Levy

260

Divano

Sofa

PAG. 102



### CAROUSEL

Design by Sebastian Herkner

1219

Divano Alu-corda intreccio fitto

Alu-thick twist rope sofa

PAG. 40



### STAR

Design by EMU

166

Divano

Sofa

PAG. 116



### COMO

Design by Angeletti—Ruzza

1205

Divano

Sofa

PAG. 48



### YARD

Design by Strefan Diez

531

Divano

Sofa

PAG. 128



### DARWIN

Design by Lucidi—Pevere

527

Divano

Sofa

PAG. 54







RE-TROUVÉ—ELLE CAFÉ—JAPAN



AERO+ROUND+SHADE—MASSERIA BAGNARA RESORT & SPA—ITALY

# EMU NEL MONDO EMU IN THE WORLD

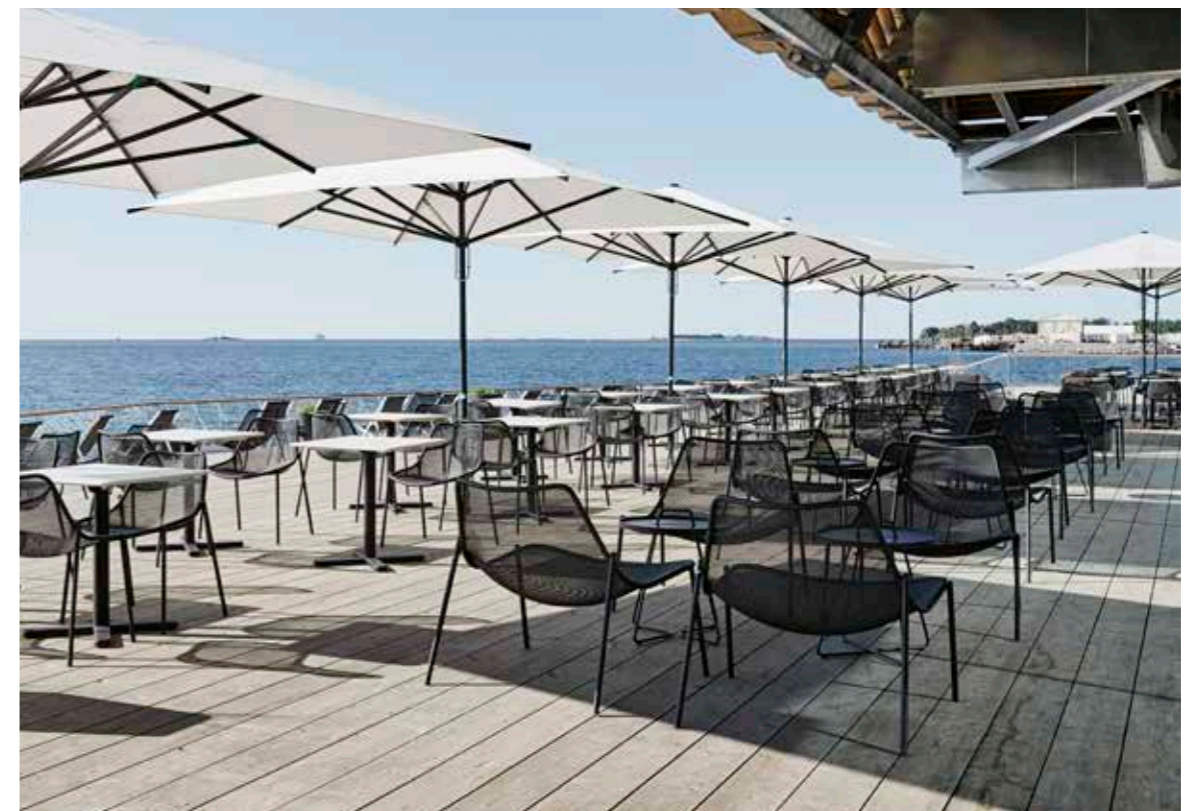

ROUND—SAUNA LÖYLY—FINLAND

# TAVOLI BASSI COFFEE TABLES

I tavoli bassi EMU sono progettati per essere facilmente abbinabili ai più svariati stili di poltrone, divani e lettini. Particolarmente performanti in ambienti esterni, questi coffee table sono disponibili in differenti misure e altezze. I piani, resistenti all'usura, alle macchie e agli agenti atmosferici, sono disponibili in diversi materiali e combinazioni colore.

EMU low tables are designed to match a wide variety of armchairs, sofas and sunbeds. These coffee tables are available in different heights and sizes and are particularly suitable in outdoor spaces. The hard-wearing, stain and weather resistant tops are available in various materials and color combinations.

## INDEX

LEGENDA—LEGEND  
● Acciaio—Steel  
● Alluminio—Aluminium  
● Legno—Wood

|     |           |     |
|-----|-----------|-----|
| 242 | ATHENA    | ●   |
| 244 | CANNOLE   | ●   |
| 246 | CAROUSEL  | ●   |
| 248 | COMO      | ●   |
| 248 | CROSS     | ●   |
| 250 | DARWIN    | ●   |
| 252 | HEAVEN    | ●   |
| 254 | HOLLY     | ● ● |
| 254 | IVY       | ●   |
| 256 | RIO R50   | ●   |
| 258 | ROUND     | ●   |
| 260 | SHINE     | ● ● |
| 260 | TAMI      | ● ● |
| 262 | TERRAMARE | ●   |
| 264 | YARD      | ●   |



Scansiona e scopri i progetti.  
Scan and discover the projects.

3418  
Tavolo basso  
Coffee table

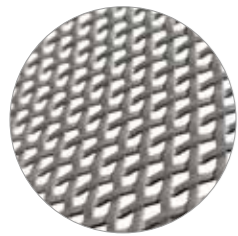

Piano in lamiera finto intreccio zincata a caldo.  
Top in hot-dip zincated simulated woven wire mesh.

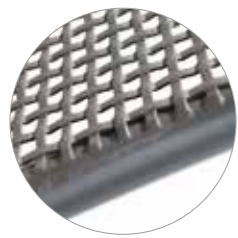

Saldatura a proiezione per una maggiore precisione estetica.  
Spot welding for greater aesthetic precision.

## PRODOTTI—PRODUCTS

| Codice/Code<br>Tipologia/Typology | Disegno/Drawing | Info |
|-----------------------------------|-----------------|------|
|-----------------------------------|-----------------|------|

3418

Tavolo basso  
Coffee table  
W100 - D60 - H40  
Kg 10,5

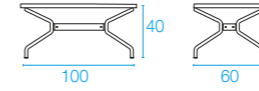

### COLORI STRUTTURA—FRAME COLORS

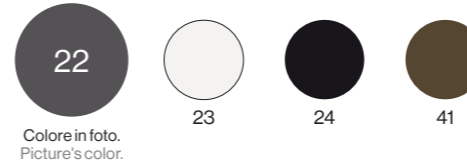

# CANNOLÈ

Design by Cristell—Gargano



Scansiona e scopri i progetti.  
Scan and discover the projects.

1087  
Tavolo basso grande  
Big coffee table



Struttura e tondini in acciaio zincato a caldo.  
Frame and bars in hot-dip zincated steel.

1088  
Tavolo basso piccolo  
Small coffee table



Piano in lamiera prezincata di acciaio.  
Top in hot-dip zincated sheet steel.

## PRODOTTI—PRODUCTS



| Codice/Code<br>Tipologia/Typology | Disegno/Drawing | Info |
|-----------------------------------|-----------------|------|
|-----------------------------------|-----------------|------|

1087  
Tavolo basso grande  
Big coffee table  
ø105 - H45  
Kg 16,8

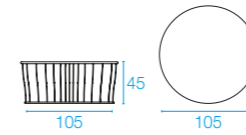

1088  
Tavolo basso piccolo  
Small coffee table  
ø60 - H55  
Kg 7,6

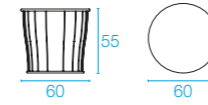

### COLORI STRUTTURA—FRAME COLORS

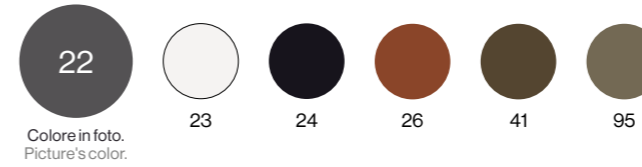

# CAROUSEL

Design by Sebastian Herkner



Scansiona e scopri i progetti.  
Scan and discover the projects.

1223

Tavolo basso quadrato  
Alu-corda intreccio fitto  
Alu-thick twist rope  
square coffee table

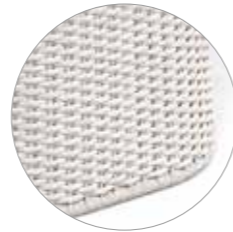

Rivestimento della base con intreccio con corda in polipropilene.  
Base covering with thick twist made of polypropylene rope.

1224

Tavolo basso rettangolare  
Alu-corda intreccio fitto  
Alu-thick twist rope  
rectangular coffee table



Sottopiedi regolabili.  
Adjustable feet.

## PRODOTTI—PRODUCTS

| Codice/Code<br>Tipologia/Typology | Disegno/Drawing | Info |
|-----------------------------------|-----------------|------|
|-----------------------------------|-----------------|------|

1223

Tavolo basso quadrato  
Alu-corda intreccio fitto  
Alu-thick twist rope  
square coffee table  
W49 - D49 - H44,5  
Kg 6,3

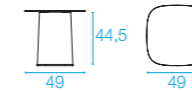

1224

Tavolo basso rettangolare  
Alu-corda intreccio fitto  
Alu-thick twist rope  
rectangular coffee table  
W110 - D80 - H30  
Kg 14,6

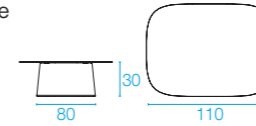

### COLORI PIANO/STRUTTURA—TOP/FRAME COLORS

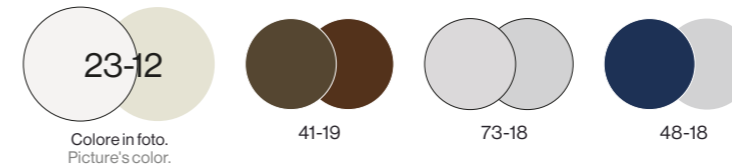

## PLUS

- Piano realizzato in lega di alluminio con angoli arrotondati.  
Top made of aluminum alloy with rounded corners.
- Base in tondino di acciaio cataforizzato su cui è costruito l'intreccio, peculiare caratteristica estetica.  
The main aesthetic feature of the product is the base in cataphorised steel bar which the weave is assembled on.
- Due differenti misure e altezze che diventano complementari.  
Tables available in two different sizes and heights that become complementary.

# COMO

Design by Jean-Marie Massaud



Scansiona e scopri i progetti.  
Scan and discover the projects.

1208  
Tavolo basso  
Coffee table



## PRODOTTI—PRODUCTS

| Codice/Code<br>Tipologia/Typology | Disegno/Drawing | Info |
|-----------------------------------|-----------------|------|
|-----------------------------------|-----------------|------|

1208

Tavolo basso  
Coffee table  
ø60 - H47  
Kg 6,5

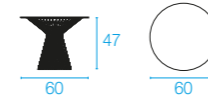

### COLORI STRUTTURA—FRAME COLORS

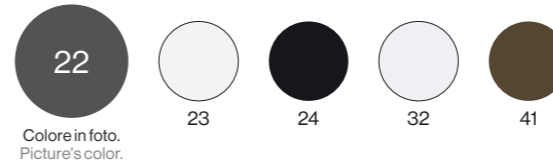

## PLUS

- Sinuoso reticolo di tondini zincati crea classiche forme affascinanti. La struttura in tondini è realizzata tramite saldatura a proiezione.— Sinuous grid of zincated bars that create classic fascinating shapes.
- Piano in lamiera zincata a caldo.— Top in hot-dip zincated sheet.

# CROSS

Design by Rodolfo Dordoni



Scansiona e scopri i progetti.  
Scan and discover the projects.

423  
Tavolo basso  
Coffee table



## PRODOTTI—PRODUCTS

| Codice/Code<br>Tipologia/Typology | Disegno/Drawing | Info |
|-----------------------------------|-----------------|------|
|-----------------------------------|-----------------|------|

423

Tavolo basso  
Coffee table  
ø70 - H30  
Kg 9,3

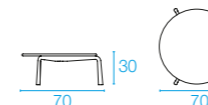

### COLORI PIANO/STRUTTURA—TOP/FRAME COLORS

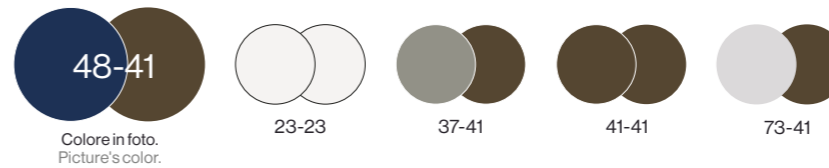

Gamba in pressofusione di lega di alluminio.  
Legs made of die-cast aluminium alloy.

## PLUS

- Piano in lamiera zincata a caldo.— Top in hot-dip zincated sheet.

# DARWIN

Design by Lucidi—Pevere



Scansiona e scopri i progetti.  
Scan and discover the projects.

526

Tavolo basso  
Coffee table



Piano in lamiera zincata a caldo con bordo arrotondato tramite imbutitura.  
Hot-dip zincated sheet top with moulded rounded edge.

## PRODOTTI—PRODUCTS



| Codice/Code<br>Tipologia/Typology | Disegno/Drawing | Info | TEST |
|-----------------------------------|-----------------|------|------|
|-----------------------------------|-----------------|------|------|

526

Tavolo basso  
Coffee table  
W70 - D70 - H40  
Kg 8,2

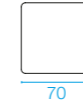
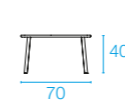

EN581-1/EN581-3

### COLORI STRUTTURA—FRAME COLORS



22  
Colore in foto.  
Picture's color.

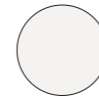

23



24



37



41



50



75



Scansiona e scopri i progetti.  
Scan and discover the projects.

495+495/V  
Tavolo basso  
Coffee table



496+494/V  
Tavolo basso  
Coffee table

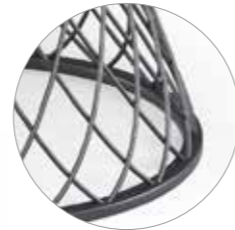

Sinuoso reticolo di tondini zincati crea forme classiche e affascinanti. La struttura in tondini è realizzata tramite saldatura a proiezione.  
Sinuous grid of hot-dip zincated bars that create classic fascinating shapes.

## PRODOTTI—PRODUCTS



| Codice/Code<br>Tipologia/Typology | Disegno/Drawing | Info |
|-----------------------------------|-----------------|------|
|-----------------------------------|-----------------|------|

### 495

Struttura pouf/tavolo basso  
Pouf/coffee table frame  
x cod. 495/S, 495/V  
ø45 - H46  
Kg 3,6

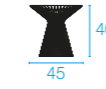

### 496

Struttura tavolo basso  
Small coffee table frame  
x cod. 494/V  
ø110 - H38  
Kg 7,7

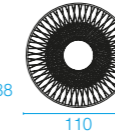
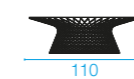

### COLORI STRUTTURA—FRAME COLORS

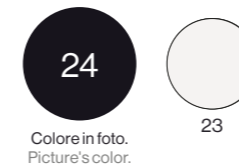

## PIANI IN CRISTALLO/CUSCINO—GLASS TOPS/CUSHION

| Codice/Code<br>Tipologia/Typology   | Colori<br>Colors | Categoria tessuto<br>Fabric category                               |
|---|------------------|--|
| <b>495/S</b><br>Cuscino seduta imbottito polipropilene<br>Polypropylene padded seat cushion<br>x cod. 495<br>ø45 - H1<br>Kg 1,8       |                  | 900/71<br>900/75<br>900/77<br>Tessuti Standard<br>Standard Fabrics |
| <b>494/V</b><br>Piano in cristallo per tavolo 4/6 posti<br>Glass top for 4/6 seats table<br>x cod. 494, 496<br>ø120 - H0,8<br>Kg 22,5 |                  | 00<br>83*  |
| <b>495/V</b><br>Piano in cristallo<br>Glass top<br>x cod. 495<br>ø50 - H0,6<br>Kg 2,9   |                  | 00<br>83*  |

\* Piano visibile in foto 83 Fumé—Glass in the picture 83 Smoky grey



# HOLLY

Design by EMU



Scansiona e scopri i progetti.  
Scan and discover the projects.

196  
Tavolo basso  
Coffee table



## PRODOTTI—PRODUCTS

| Codice/Code<br>Tipologia/Typology | Disegno/Drawing | Info |
|-----------------------------------|-----------------|------|
|-----------------------------------|-----------------|------|

196  
Tavolo basso  
Coffee table  
W44 - D45 - H43  
Kg 2,9

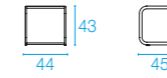

### COLORI STRUTTURA—FRAME COLORS

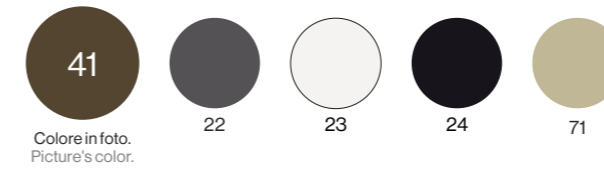

## PLUS

• Doppio piano d'appoggio.— Double top.



# IVY

Design by Paola Navone



Scansiona e scopri i progetti.  
Scan and discover the projects.

589  
Tavolo basso  
Coffee table

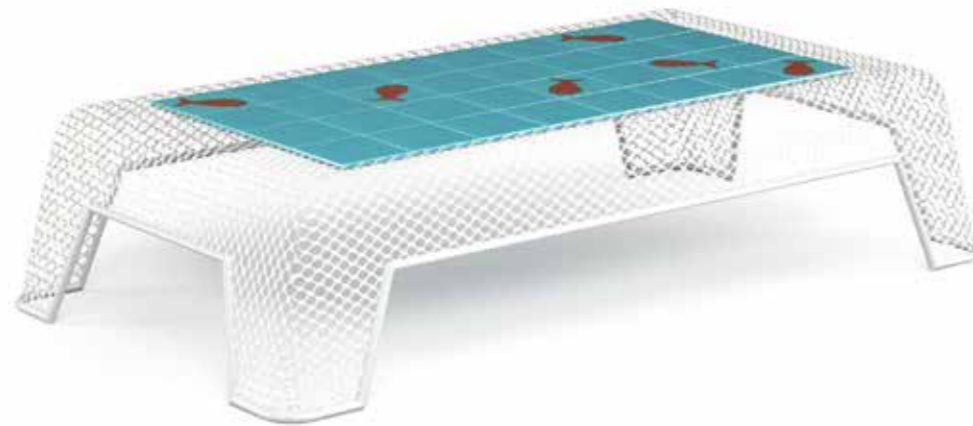

## PRODOTTI—PRODUCTS

| Codice/Code<br>Tipologia/Typology | Disegno/Drawing | Info |
|-----------------------------------|-----------------|------|
|-----------------------------------|-----------------|------|

589  
Tavolo basso  
Coffee table  
W135 - D74 - H30  
Kg 14,2

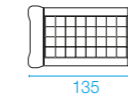
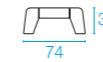

### COLORI STRUTTURA—FRAME COLORS



| Codice/Code<br>Tipologia/Typology | Colori<br>Colors |
|-----------------------------------|------------------|
|-----------------------------------|------------------|

590  
Mattonelle con pesce o scarabeo  
Tiles with fish or scrabble  
x cod. 589  
W12 - D12 - H1,5 Kg 12



01

65

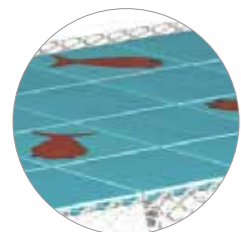

Optional: Kit di mattonelle in terracotta di Deruta dipinte a mano. Possibilità di scelta tra due kit: Variante Pesce (6 mattonelle con pesce e 26 mattonelle turchesi) e Variante Scarabeo (6 mattonelle con scarabeo e 26 mattonelle bianche). Le mattonelle sono appoggiate sul piano di lamiera ed il cliente può comporre il disegno a suo piacimento.  
Optional for low table: kit of hand-painted Deruta terracotta tiles. You can choose between two colors: Fish variant (6 tiles with fish and 26 turquoise tiles) and Beetle variant (6 tiles with beetle and 26 white tiles). The tiles stand on the sheet metal surface and the customer can compose the design according to his/her will.

## PLUS

• Tavolo con piano in lamiera zincata a caldo.  
Table top made of hot-dip zincated sheet.

# RIO R50

Design by Cristell—Gargano



Scansiona e scopri i progetti.  
Scan and discover the projects.

797

Tavolo basso  
Coffee table



## PRODOTTI—PRODUCTS



| Codice/Code<br>Tipologia/Typology | Disegno/Drawing | Info |
|-----------------------------------|-----------------|------|
|-----------------------------------|-----------------|------|

797

Tavolo basso  
Coffee table  
W104 - D104 - H42  
Kg 9,8

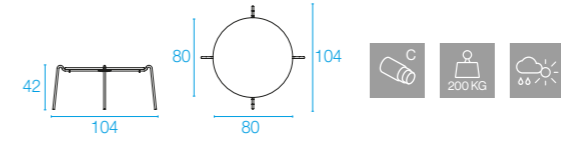

### COLORI STRUTTURA—FRAME COLORS

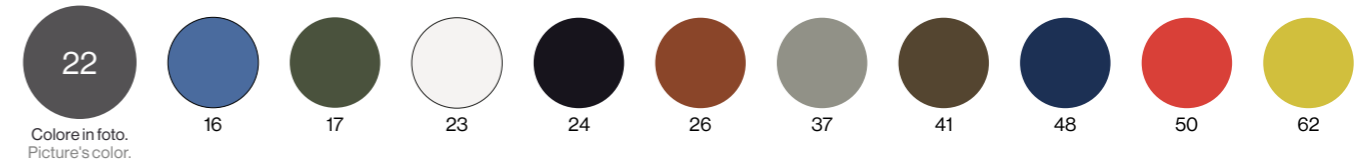

### PLUS

- Piano in lamiera zincata a caldo con bordo stondato.  
Top in hot-dip zincated sheet with rounded edge.
- Gambe in acciaio Asform con elevata capacità di resistenza meccanica.  
Asform steel legs with high static load resistance.

# ROUND

Design by Christophe Pillet



Scansiona e scopri i progetti.  
Scan and discover the projects.

482  
Tavolo snack  
Snack table



483  
Tavolo basso  
Coffee table



477  
Tavolo basso  
Coffee table



## PRODOTTI—PRODUCTS



| Codice/Code<br>Tipologia/Typology | Disegno/Drawing | Info |
|-----------------------------------|-----------------|------|
|-----------------------------------|-----------------|------|

482  
Tavolo snack  
Snack table  
W100 - D70 - H45  
Kg 12,1

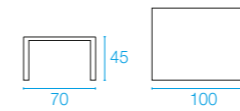

483  
Tavolo basso  
Coffee table  
W45 - D45 - H42  
Kg 4,5

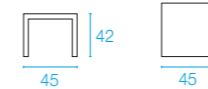

477  
Tavolo basso  
Coffee table  
W80 - D80 - H42  
Kg 11,7

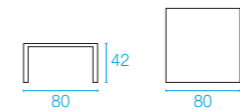

### COLORI STRUTTURA X COD. 482—FRAME COLORS X COD. 482

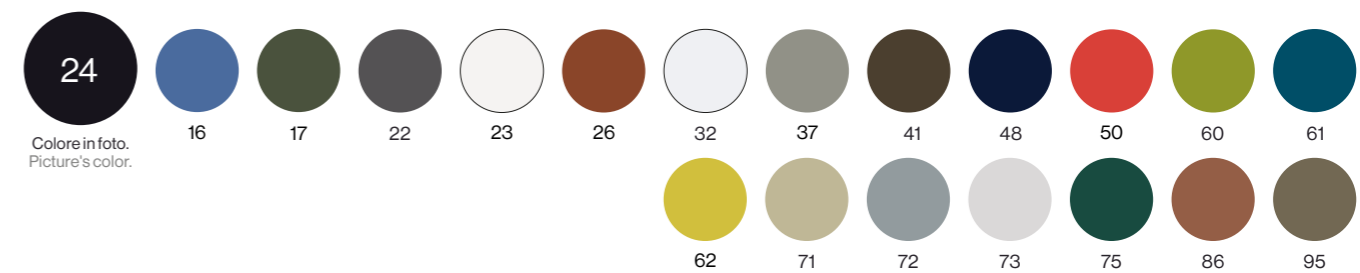

### COLORI STRUTTURA X COD. 483, 477—FRAME COLORS X COD. 483, 477

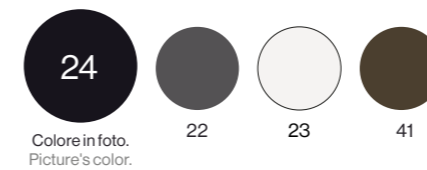

## PLUS

- Piano in lamiera zincata a caldo.—Hot-dip zincated sheet top.
- Cod. 482: altezza di 45 cm, maggiore rispetto al coffee table; altezza adatta per condividere un aperitivo, uno snack o ancora per utilizzare un computer portatile stando rilassati sul divano.  
Cod. 482: 45 cm high - higher than a usual coffee table; ideal for sharing an appetizer, a snack or even to use a laptop while relaxing on the couch.
- Piano autolivellante.—Self-levelling top.

# SHINE

Design by Arik Levy



Scansiona e scopri i progetti.  
Scan and discover the projects.

252  
Tavolo basso  
Coffee table



Piano in teak FSC®.  
Table top available in teak FSC®.

## PRODOTTI—PRODUCTS

| Codice/Code<br>Tipologia/Typology | Disegno/Drawing | Info | TEST |
|-----------------------------------|-----------------|------|------|
|-----------------------------------|-----------------|------|------|

252  
Tavolo basso  
Coffee table  
W79 - D79 - H40  
Kg 8,2

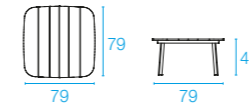

EN581-1/EN581-3



### COLORI STRUTTURA/PIANO IN TEAK—FRAME/TEAK TOP COLORS

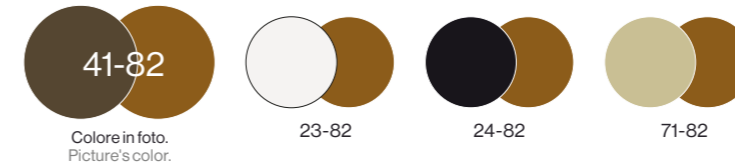

# TAMI

Design by Patrick Norguet



Scansiona e scopri i progetti.  
Scan and discover the projects.

766  
Tavolo basso  
Coffee table

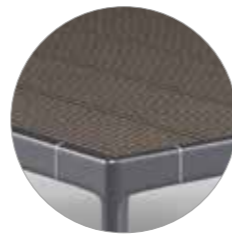

Doghe in WPC.  
Slats available in extruded WPC.

767  
Tavolo basso  
Coffee table

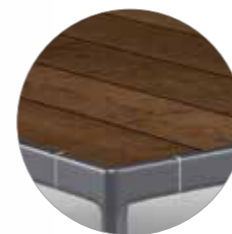

Doghe in bambù.  
Slats available in bamboo.

## PRODOTTI—PRODUCTS

| Codice/Code<br>Tipologia/Typology | Disegno/Drawing | Info |
|-----------------------------------|-----------------|------|
|-----------------------------------|-----------------|------|

766  
Tavolo basso  
Coffee table  
W89 - D86 - H25  
Kg 27,2/30,6

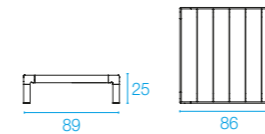

767  
Tavolo basso  
Coffee table  
W132 - D57 - H42  
Kg 27,6/31,6

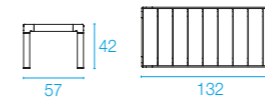

### COLORI STRUTTURA/DOGHE—FRAME/SLATS COLORS

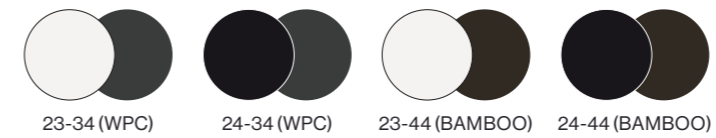

## PLUS

• Giunti in pressofusione di alluminio.—Aluminium die-cast joints.



Scansiona e scopri i progetti.  
Scan and discover the projects.



**732+735P**  
Tavolo basso piccolo  
Small coffee table



34 Basaltina



**733+736P**  
Tavolo basso medio  
Medium coffee table



35 Bianco statuario  
35 Statuario white



**734+737P**  
Tavolo basso grande  
Big coffee table



36 Emperador



## PRODOTTI—PRODUCTS

| Codice/Code<br>Tipologia/Typology | Disegno/Drawing | Info |
|-----------------------------------|-----------------|------|
|-----------------------------------|-----------------|------|

**732+735P**  
Tavolo basso piccolo  
Small coffee table  
W48 - D48 - H40  
Kg 3,1

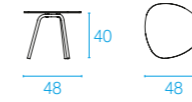

**733+736P**  
Tavolo basso medio  
Medium coffee table  
W75 - D70 - H30  
Kg 6,3

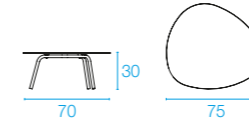

**734+737P**  
Tavolo basso grande  
Big coffee table  
W108 - D64 - H35  
Kg 8,4

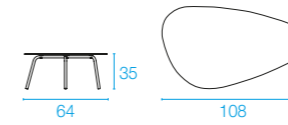

### COLORI STRUTTURA/PIANO—FRAME/TOP COLORS

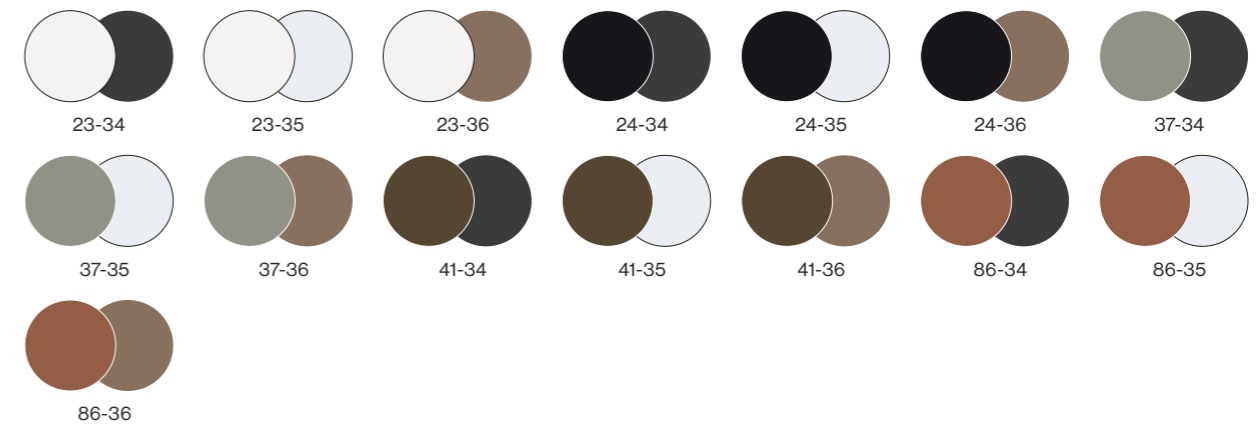

### PLUS

- Combinazione colore struttura e piani: possibilità di personalizzare e combinare i 3 colori dei piani con i 5 diversi colori della struttura.— Possibility to customize and combine 3 colors of different tops on 5 different frame colors.
- Piano in gres porcellanato, per una migliore resistenza all'usura, macchie e agenti atmosferici.  
Porcelain stoneware top for better resistance to wear, stains and atmospheric agents.



Scansiona e scopri i progetti.  
Scan and discover the projects.

507  
Tavolo basso  
Coffee table



509  
Tavolo basso  
Coffee table



## PRODOTTI—PRODUCTS



| Codice/Code<br>Tipologia/Typology | Disegno/Drawing | Info | TEST |
|-----------------------------------|-----------------|------|------|
|-----------------------------------|-----------------|------|------|

|  |  |  |                 |
|--|--|--|-----------------|
| 507<br>Tavolo basso<br>Coffee table<br>W60 - D60 - H40<br>Kg 4,0 |  |  | EN581-1/EN581-3 |
|--|--|--|-----------------|

|  |  |  |  |
|--|--|--|--|
| 509<br>Tavolo basso<br>Coffee table<br>ø50 - H50<br>Kg 3,5 |  |  |  |
|--|--|--|--|

### COLORI STRUTTURA—FRAME COLORS

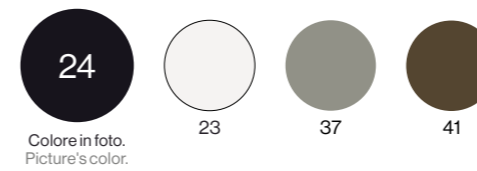

# EMU NEL MONDO EMU IN THE WORLD

SHINE+SHADE—CLUB MED EXCLUSIVE COLLECTION—ITALY



HOLLY—HARRISON URBY—USA



ROUND—CAIDOMINICI—ITALY



# LETTINI E SDRAIO SUNBEDS AND DECK CHAIRS

Robusti, pratici, leggeri, confortevoli, impilabili e perfettamente resistenti agli agenti atmosferici. I lettini e le sdraio EMU sono dotati di semplici meccanismi con cui ottenere diverse inclinazioni degli schienali. Le sedute ergonomiche garantiscono sostegno e comodità in uso. Ne completano la funzionalità alcuni optional: tetti parasole, reti e braccioli porta oggetti, poggiatesta, cuscini e ruote.

Sturdy, practical, light, comfortable, stackable and perfectly weather resistant, EMU sunbeds and deck chairs have user-friendly, reclining mechanisms to adjust the backrests. The ergonomic seats guarantee support and comfort. Optional accessories provide additional functions: sunbed roofs, storage nets and arms, footrests, cushions and wheels.

## INDEX

LEGENDA—LEGEND  
● Acciaio—Steel  
● Alluminio—Aluminium  
● Legno—Wood

|     |           |     |
|-----|-----------|-----|
| 270 | BAHAMA    | ●   |
| 272 | HOLLY     | ●   |
| 274 | ROUND     | ●   |
| 276 | SHINE     | ● ● |
| 278 | SNOOZE    | ●   |
| 282 | TERRAMARE | ●   |
| 284 | TIKI      | ●   |
| 286 | VETTA     | ●   |
| 288 | YARD      | ●   |



# BAHAMA

Design by EMU



Scansiona e scopri i progetti.  
Scan and discover the projects.

170  
Sdraio  
Deck chair



Struttura in tubo di acciaio zincato a caldo internamente ed esternamente.  
Inside and outside hot-dip zincated steel pipe.



Blocco anteriore basculante.  
Tilting front block.



Ottima per il rimessaggio invernale, piegata occupa pochissimo spazio.  
Perfect for winter storage, it can be folded and takes up very little space.

## PRODOTTI—PRODUCTS

| Codice/Code<br>Tipologia/Typology | Disegno/Drawing | Info |
|-----------------------------------|-----------------|------|
|-----------------------------------|-----------------|------|

170  
Sdraio  
Deck chair  
W58 - D108 - H95 Kg 5,4

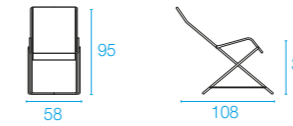

### COLORI STRUTTURA/SEDUTA E SCHIENALE—FRAME/SEAT AND BACKREST COLORS

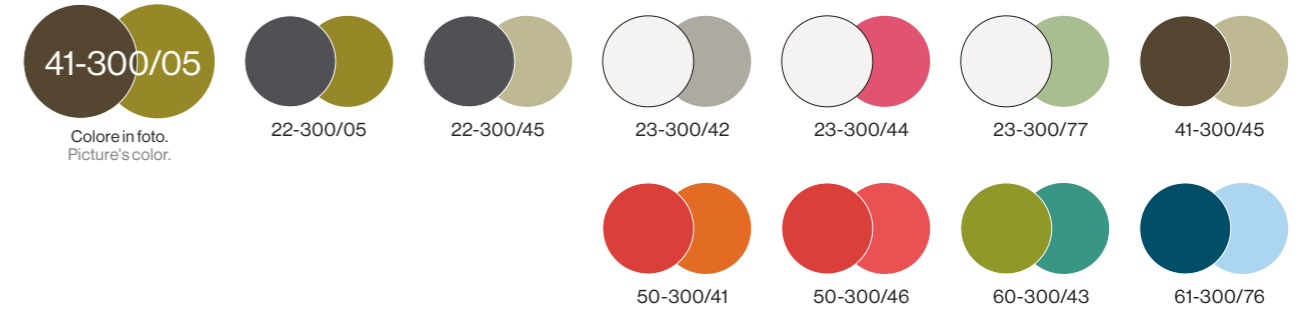

Le immagini dei colori sono a scopo illustrativo. Per vedere la trama degli EMU-Tex, consultare pg. 341.  
All colors images shown are for illustration purposes only. Look at pg. 341 to see the texture of the EMU-Tex.

### COMBINAZIONI CONSIGLIATE—SUGGESTED MATCHINGS

270



ROUND  
Cod. 483  
Tavolo basso  
Coffee table  
PAG. 258



HOLLY  
Cod. 195  
Letino impilabile con ruote a scomparsa  
Stackable sunbed with hidden wheels  
PAG. 272



HOLLY  
Cod. 196  
Tavolo basso  
Coffee table  
PAG. 254

## PLUS

• Un'icona intramontabile, da 50 anni sul mercato, dal design attualissimo. Robusta, pratica, leggera, confortevole e sicura.— A timeless icon with a contemporary design, since 50 years on the market. Sturdy, handy, light, comfortable and safe.

271

# HOLLY

Design by EMU



Scansiona e scopri i progetti.  
Scan and discover the projects.



195

Lettino impilabile  
con ruote a scomparsa

Stackable  
sunbed with  
hidden wheels



Dotato di piccole ruote, a scomparsa, è estremamente facile e leggero da muovere.  
Equipped with small hidden wheels, it is extremely easy and light to move.



Impilabilità fino a 8 pezzi.  
The sunbed can be stacked up to 8 pieces.

## PRODOTTI—PRODUCTS

| Codice/Code<br>Tipologia/Typology | Disegno/Drawing | Info |
|-----------------------------------|-----------------|------|
|-----------------------------------|-----------------|------|

195

Lettino impilabile  
con ruote a scomparsa  
Stackable sunbed with  
hidden wheels  
W202 - D79 - H 37/103  
Kg 13,6

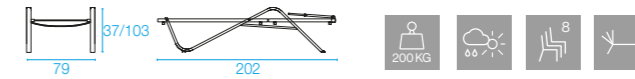

195/T

Tettino  
Sunbed roof  
W53 - D65 - H4  
Kg 1,0

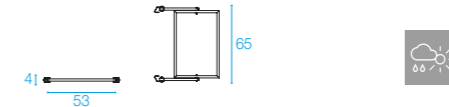

### COLORI STRUTTURA/TELO—FRAME/CLOTH COLORS



Le immagini dei colori sono a scopo illustrativo. Per vedere la trama degli EMU-TEX, consultare pg. 341.  
All colors images shown are for illustration purposes only. Look at pg. 341 to see the texture of the EMU-TEX.

### ALTRI PRODOTTI IN COLLEZIONE—OTHER COLLECTION'S PRODUCTS

272



HOLLY  
Cod. 1311  
Poltrona reclinabile  
Reclining lounge chair  
PAG. 62



HOLLY  
Cod. 1313  
Poggiapiedi  
Foot stool  
PAG. 62



HOLLY  
Cod. 196  
Tavolo basso  
Coffee table  
PAG. 254

## PLUS

- Robusta struttura in tubolare di alluminio.—Sturdy frame in aluminium frame.
- Disponibile come accessorio il tettino parasole.—The sunbed roof is available as accessory.

273

# ROUND

Design by Christophe Pillet



Scansiona e scopri i progetti.  
Scan and discover the projects.

468

Lettino impilabile  
Stackable  
sunbed

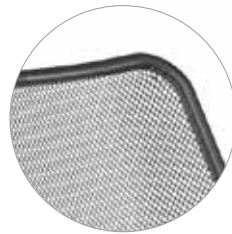

Lettino ergonomico in lamiera stirata zincata a caldo.  
Ergonomic sunbed made of hot-dip zincated sheet.

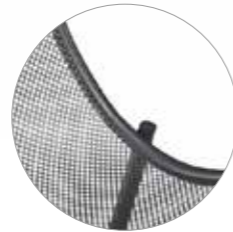

Tappi in acciaio zincato come protezione per le gambe durante impilamento.  
Hot-dip zincated steel caps to preserve the legs when sunbeds are stacked.



Fissaggio cuscino con elastici e fermacorda.  
Cushion fastening with rubber band and clip.

## PRODOTTI—PRODUCTS

| Codice/Code<br>Tipologia/Typology | Disegno/Drawing | Info |
|-----------------------------------|-----------------|------|
|-----------------------------------|-----------------|------|

468

Lettino impilabile  
Stackable sunbed  
W78 - D160 - H77  
Kg 14,0

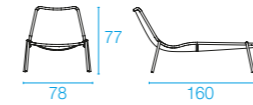

### COLORI STRUTTURA—FRAME COLORS

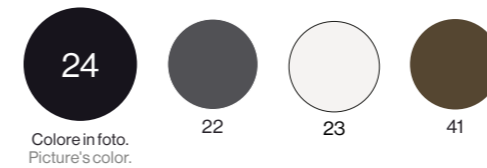

### CUSCINO—CUSHION

| Codice/Code<br>Tipologia/Typology   | Colori<br>Colors   | Categoria tessuto<br>Fabric category |
|---|--|--------------------------------------|
| C/468<br>Cuscino intero polipropilene<br>Polypropylene whole cushion<br>x cod. 468<br>W132 - D47/65/52 - H4<br>Kg 1,6 | <div style="display: flex; gap: 5px;"> <div style="border: 1px solid black; padding: 2px;">900/71</div> <div style="border: 1px solid black; padding: 2px;">900/75</div> <div style="border: 1px solid black; padding: 2px;">900/77</div> </div> | Tessuti Standard<br>Standard Fabrics |



### ALTRI PRODOTTI IN COLLEZIONE—OTHER COLLECTION'S PRODUCTS

274



ROUND  
Cod. 469  
Poltrona  
Lounge chair  
PAG. 94



ROUND  
Cod. 477  
Tavolo basso  
Coffee table  
PAG. 258



ROUND  
Cod. 482  
Tavolo basso  
Coffee table  
PAG. 258

## PLUS

• Cuscini disponibili per aumentare il comfort.—Cushions available for more comfort.

275

# SHINE

Design by Arik Levy



Scansiona e scopri i progetti.  
Scan and discover the projects.

295

Lettino impilabile con ruote a scomparsa

Stackable sunbed with hidden wheels



Le ruote a scomparsa non interferiscono con le linee volute dal design ma ne garantiscono una facile trasportabilità ed un pratico rimessaggio.

The retractable wheels do not interfere with the design lines, but guarantee an easy use for moving and storage.

289

Daybed impilabile con ruote a scomparsa

Stackable daybed with hidden wheels



Dotato di vari accessori per implementarne gli usi: bracciolo/vassoio di appoggio, rete portaoggetti e tettino. Various accessories are provided to implement the uses: armrest/support tray, storage net and roof.

## PRODOTTI—PRODUCTS



| Codice/Code<br>Tipologia/Typology | Disegno/Drawing | Info | TEST |
|-----------------------------------|-----------------|------|------|
|-----------------------------------|-----------------|------|------|

295

Lettino impilabile con ruote a scomparsa  
Stackable sunbed with hidden wheels  
W209 - D77 - H36/97  
Kg 17,6

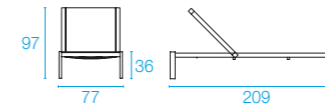

EN581-1/ EN581-2

289

Daybed impilabile con ruote a scomparsa  
Stackable daybed with hidden wheels  
W211 - D148 - H36/97  
Kg 29,5

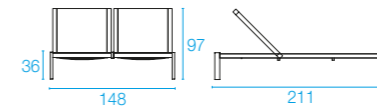

295B

N.1 bracciolo  
N.1 armrest  
x cod. 289, 295  
W50 - D23 - H2 Kg 1,5



82



295R

Rete porta oggetti  
Storage net  
x cod. 289, 295  
W45 - D50 Kg 0,1

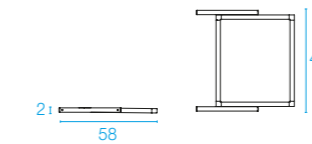

|    |        |
|----|--------|
| 23 | 300/52 |
| 24 | 300/95 |
| 41 | 300/51 |
| 71 | 300/50 |
| 71 | 300/86 |

295T

Tettino  
Sunbed roof  
x cod. 289, 295  
W58 - D45 - H2 Kg 2,2

### COLORI STRUTTURA/TELO—FRAME/CLOTH COLORS

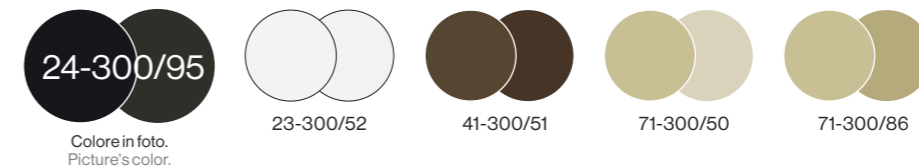

Le immagini dei colori sono a scopo illustrativo. Per vedere la trama degli EMU-Tex, consultare pg. 341.  
All colors images shown are for illustration purposes only. Look at pg. 341 to see the texture of the EMU-Tex.

### ALTRI PRODOTTI IN COLLEZIONE—OTHER COLLECTION'S PRODUCTS

276



SHINE  
Cod. 252  
Tavolo basso  
Coffee table  
PAG. 260



SHINE  
Cod. 249  
Poltrona  
Lounge chair  
PAG. 106



SHINE  
Cod. 260  
Divano  
Sofa  
PAG. 102

## PLUS

- L'estetica pulita ed essenziale è realizzata con tubolare in lega di alluminio a sezione rettangolare. Sunbed with a clean and essential aesthetic, made with tubular aluminium alloy with a rectangular section.
- Cod. 289: un semplice meccanismo permette di inclinare sia lo schienale che l'altezza dei piedi. Cod. 289: a simple mechanism allows to recline both the backrest and the bottom of the sunbed.

277

# SNOOZE

Design by Chiaramonte—Marin



Scansiona e scopri i progetti.  
Scan and discover the projects.

201  
Sdraio  
Deck chair



Bracciali in EMU-Tex impermeabile che fungono da regolatori dell'inclinazione, supportati da piastre in acciaio inox.  
Armrests in waterproof EMU-Tex that act as tilt regulators, supported by stainless steel plates.

204  
Poggiapiedi  
Foot stool



207  
Lettino impilabile  
Stackable sunbed



278

## PRODOTTI—PRODUCTS



| Codice/Code<br>Tipologia/Typology  | Disegno/Drawing | Info | TEST            |
|--|-----------------|------|-----------------|
| 201<br>Sdraio<br>Deck chair<br>W75 - D91 - H105<br>Kg 7,9                        |                 |      | EN581-1/EN581-2 |
| 204<br>Poggiapiedi<br>Foot stool<br>W72 - D32 - H43<br>Kg 3,4                    |                 |      |                 |
| 207<br>Lettino impilabile<br>Stackable sunbed<br>W215 - D92 - H37/102<br>Kg 19,0 |                 |      |                 |

### COLORI STRUTTURA/SEDUTA E SCHIENALE—FRAME/SEAT AND BACKREST COLORS

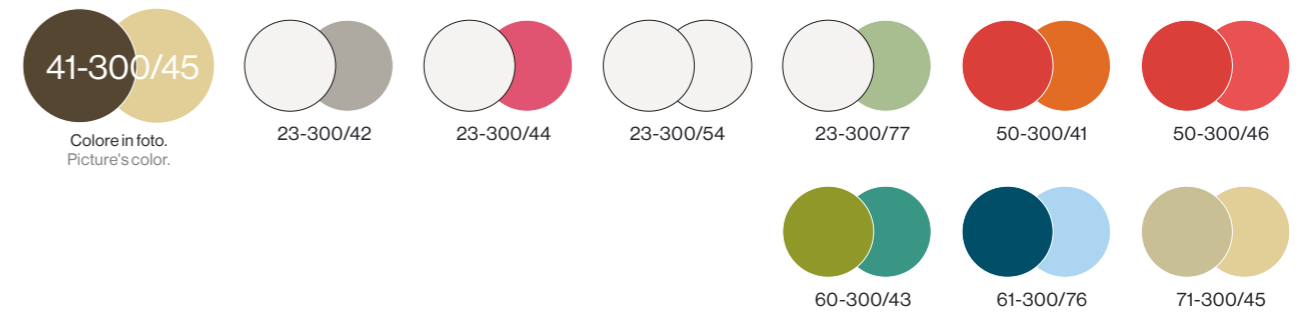

Le immagini dei colori sono a scopo illustrativo. Per vedere la trama degli EMU-Tex, consultare pg. 341.  
All colors images shown are for illustration purposes only. Look at pg. 341 to see the texture of the EMU-Tex.

### PLUS

- Seduta extra confortevole, avvolgente grazie alla sua concavità e naturale adattamento del tessuto in uso.  
Extra comfortable seat, enveloping through its concavity and the natural adaptation of the fabric used.
- L'ampia gamma dei colori disponibili rende questa collezione trasversale ai più svariati contesti contract.  
The wide colors range makes this collection suitable to various contract contexts.
- Telo sostituibile facilmente attraverso la semplice rimozione delle viti di fissaggio.  
Sunbed cloth easily replaceable through the simple fixing screws.
- Struttura in tubo acciaio zincato a caldo ed EMU-Tex impermeabile.  
Frame in hot-dip zincated steel pipe and waterproof EMU-Tex.
- Inclinazione regolabile su due posizioni.— Adjustable inclination on two positions.
- Cod. 207 lettino con ruote a vista.— Cod. 207 sunbed with visible wheels.
- Lettino impilabile fino a 4 pezzi.— Sunbeds stackable up to 4 pieces.

279

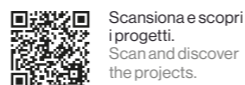

219  
Sdraio Cozy  
Cozy deck chair



Bracciolo in microfibra per un elegante effetto tattile e visivo.  
Microfiber armrest for an elegant touch, look and feel.



Il telo in maglia sintetica dalla texture caratteristica è accoppiato all'imbottitura in filo drenante, così da creare una seduta avvolgente e confortevole. La sapiente combinazione con la struttura in acciaio mantiene le prerogative di qualità e resistenza tipiche dei prodotti EMU.  
The assembly between the synthetic mesh cloth and its distinctive texture with the inner draining fiber padding makes the seat enveloping and comfortable. The skillful combination to steel frame keeps unchanged quality and resistance standards of EMU products.

229  
Poggiapiedi Cozy  
Cozy foot stool



## PRODOTTI—PRODUCTS

| Codice/Code<br>Tipologia/Typology | Disegno/Drawing | Info |
|-----------------------------------|-----------------|------|
|-----------------------------------|-----------------|------|

219  
Sdraio Cozy  
Cozy deck chair  
W75 - D91 - H105  
Kg 9,6

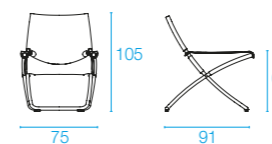

229  
Poggiapiedi cozy  
Cozy foot stool  
W72 - D32 - H43  
Kg 3,4

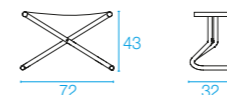

### COLORI STRUTTURA/FRONTE TELO/RETRO TELO E BRACCIOLI FRAME/FRONT CLOTH/REAR CLOTH AND ARMRESTS



Le immagini dei colori sono a scopo illustrativo. Per vedere la trama delle maglie sintetiche, consultare pg. 340.  
All colors images shown are for illustration purposes only. Look at pg. 340 to see the texture of the synthetic meshes.

### ALTRI PRODOTTI IN COLLEZIONE—OTHER COLLECTION'S PRODUCTS



## PLUS

- Naturale evoluzione della Snooze, Cozy ne mutua il comfort, la praticità, funzionalità e linea, evolvendo in una versione più curata, imbottita ed accogliente per utilizzi che vanno oltre l'outdoor, come porticati, verande e ambienti interni.—The natural evolution of the Snooze, Cozy changes its comfort, practicality, functionality and line, evolving into a more refined, padded and welcoming version for uses beyond the outdoors and also placed in porticoes, verandas and interior contexts.
- Disponibili 2 colori lucidi per la struttura, unicamente utilizzati per Snooze Cozy.—2 polished colors available for the frame, exclusively used for Cozy Snooze.
- Telo esterno che permette un facile drenaggio dell'acqua.  
An external cloth allows an easy water drainage.



Scansiona e scopri i progetti.  
Scan and discover the projects.



727

Lettino impilabile  
Stackable sunbed



L'ergonomicità della seduta ne garantisce sostegno e comodità in uso.  
Ergonomic seat that guarantees support and comfort in use.



Impilabile.—Stackable.

## PRODOTTI—PRODUCTS

| Codice/Code<br>Tipologia/Typology | Disegno/Drawing | Info | TEST |
|-----------------------------------|-----------------|------|------|
|-----------------------------------|-----------------|------|------|

727

Lettino impilabile  
Stackable sunbed  
W203 - D92 - H64  
Kg 13,6

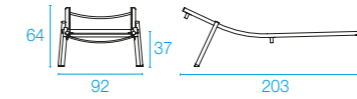

EN581-1/ EN581-2

### COLORI STRUTTURA/TELO—FRAME/CLOTH COLORS



Le immagini dei colori sono a scopo illustrativo. Per vedere la trama degli EMU-TEX, consultare pg. 341.  
All colors images shown are for illustration purposes only. Look at pg. 341 to see the texture of the EMU-TEX.

### ALTRI PRODOTTI IN COLLEZIONE—OTHER COLLECTION'S PRODUCTS

282



TERRAMARE  
Cod. 733+736P  
Tavolo basso medio  
Medium coffee table  
PAG. 262



TERRAMARE  
Cod. 726  
Tavolo smart  
Smart table  
PAG. 200

## PLUS

• Struttura in tubolare di lega di alluminio. Telo in EMU-TEX che permette l'utilizzo del lettino anche senza cuscino.—Sunbed with aluminium alloy tubular frame and EMU-TEX cloth that allows the use of the sunbed even without a cushion.

283



Scansiona e scopri i progetti.  
Scan and discover the projects.

198  
Lettino impilabile  
Stackable sunbed



Grande attenzione e ricercatezza estetica per un prodotto dalle linee pure e pulite.

Profili in alluminio realizzati per nascondere tutti gli elementi strutturali e donare armonia al design.

Great attention and aesthetic refinement for a product with pure and streamlined lines. Aluminium profiles designed to conceal all structural elements and give harmony design.

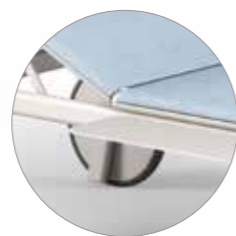

Configurabile con accessori: ruote di grandi dimensioni, bracciolo/vassoio laterale, telo portaoggetti e tettino in EMU-Tex.

Available accessories: large wheels, armrest/tray, storage cloth and sunbed roof in EMU-Tex.



## COMBINAZIONI CONSIGLIATE—SUGGESTED MATCHINGS



YARD  
Cod. 509  
Tavolo basso  
Coffee table  
PAG. 264



BREEZE  
Cod. 799  
Poltroncina  
Armchair  
PAG. 28



CIAK  
Cod. 974  
Sedia regista  
Director's chair  
PAG. 44

## PRODOTTI—PRODUCTS

| Codice/Code<br>Tipologia/Typology   | Disegno/Drawing | Info |
|---|-----------------|------|
| 198<br>Lettino impilabile<br>Stackable sunbed<br>W200 - D67 - H37/101 Kg 12,2 |                 |      |
| 198B<br>N.1 bracciolo<br>N.1 armrest<br>W49 - D17,5 - H4 Kg 1,5               |                 |      |
| 198P<br>Telo portaoggetti<br>Storage cloth<br>W88 - D50,5 - H2 Kg 0,3         |                 |      |
| 198R<br>N.2 ruote<br>N.2 wheels<br>ø27 - H5 una—each Kg 1,6                   |                 |      |
| 198T<br>Tettino<br>Sunbed roof<br>W40 - D62 - H2 Kg 1,5                       |                 |      |

### COLORI STRUTTURA/TELO X COD. 198, 198T—FRAME/CLOTH COLORS X COD. 198, 198T

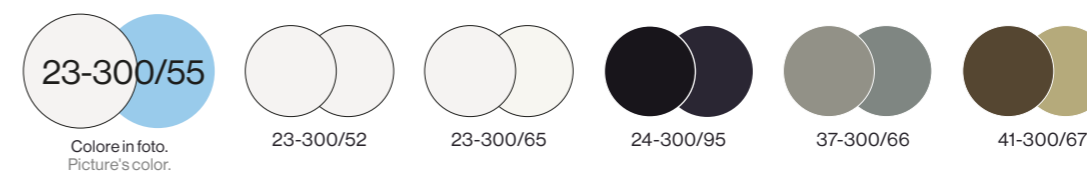

### COLORI STRUTTURA X COD. 198B, 198R—FRAME COLORS X COD. 198B, 198R

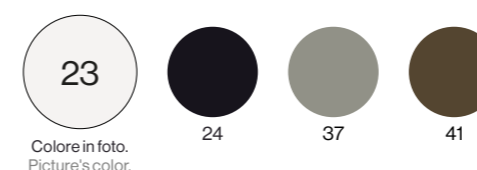

### COLORI TELO X COD. 198P—CLOTH COLORS X COD. 198P

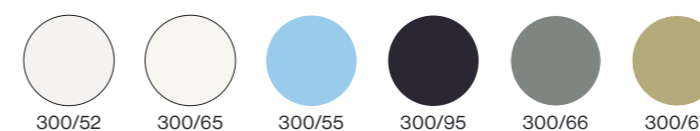

Le immagini dei colori sono a scopo illustrativo. Per vedere la trama degli EMU-Tex, consultare pg. 341.  
All colors images shown are for illustration purposes only. Look at pg. 341 to see the texture of the EMU-Tex.

\*Impilabile a 6 senza le ruote. Impilabile a 4 con le ruote ma senza bracciolo/i. Impilabile a 2 con ruote e bracciolo/i.  
Without the wheels, stackable up to 6 units. With the wheels but without the armrests, stackable up to 4 units.  
With the wheels and the armrests, stackable up to 2 units.

## PLUS

- Possibilità di smontare il telo per una facile sostituzione.— Possibility to remove the cloth for easy replacement.
- Impilabile anche con le ruote.— Stackable even with wheels.
- La grande leggerezza e la solidità delle ruote ne permettono una facile movimentazione.— Lightness and wheels solidity allow an easy handling.





Scansiona e scopri i progetti.  
Scan and discover the projects.

171  
Sdraio  
Deck chair



Elegante, ricercata nell'uso di materiali ricchi, redancie in acciaio inossidabile, teli dai colori sofisticati.  
Elegant, refined in the use of rich materials, stainless steel marine thimbles, sophisticated colors.



Schienale regolabile in due posizioni.  
Adjustable backrest in two different inclinations.

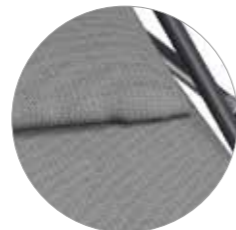

Telo EMU-Tex.  
EMU-Tex cloth.

## PRODOTTI—PRODUCTS



| Codice/Code<br>Tipologia/Typology | Disegno/Drawing | Info |
|-----------------------------------|-----------------|------|
|-----------------------------------|-----------------|------|

171  
Sdraio—Deck chair  
W78 - D104/110 - H90/80 Kg 7,7

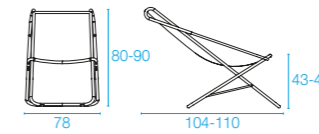

### COLORI STRUTTURA/SEDUTA E SCHIENALE/BRACCIOLI FRAME/SEAT AND BACKREST/ARMRESTS COLORS

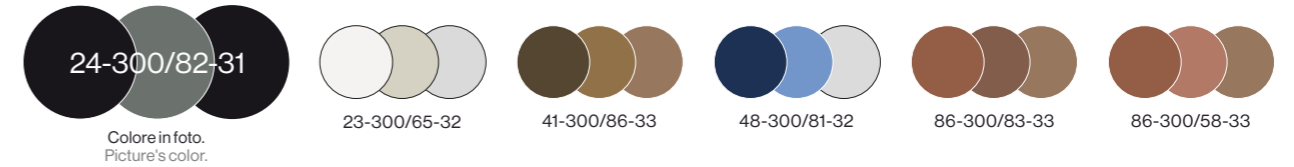

Le immagini dei colori sono a scopo illustrativo. Per vedere la trama degli EMU-Tex, consultare pg. 341.  
All colors images shown are for illustration purposes only. Look at pg. 341 to see the texture of the EMU-Tex.

## CUSCINI—CUSHIONS

| Codice/Code<br>Tipologia/Typology   | Colori tessuto<br>Fabric colors   | Categoria tessuto<br>Fabric category |
|---|---|--------------------------------------|
| C/171<br>Cuscino poggiatesta EMU-Tex<br>EMU-Tex headrest cushion<br>x cod. 171<br>W53 - D20 - H6 Kg 0,3 | <ul style="list-style-type: none"> <li>300/58</li> <li>300/65</li> <li>300/81</li> <li>300/82*</li> <li>300/83</li> <li>300/86</li> </ul> | EMU-Tex                              |

\* Cuscino visibile in foto—Cushion in the picture



Scansiona e scopri i progetti.  
Scan and discover the projects.

504

Lettino impilabile  
Stackable sunbed

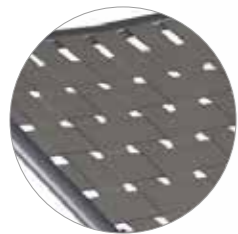

Struttura in alluminio e cinghie in fibre di polipropilene e fili di gomma sintetica.  
Aluminium frame with seat and backrest made of polypropylene fibres and synthetic rubber threads.



Schienale reclinabile.  
Reclining backrest.



Impilabile.—Stackable.



| Codice/Code<br>Tipologia/Typology | Disegno/Drawing | Info |
|-----------------------------------|-----------------|------|
|-----------------------------------|-----------------|------|

504

Lettino impilabile  
Stackable sunbed  
W200 - D75 - H38/101 Kg 15,4

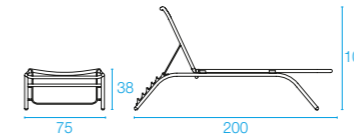

### COLORI STRUTTURA/SEDUTA E SCHIENALE—FRAME/SEAT AND BACKREST COLORS

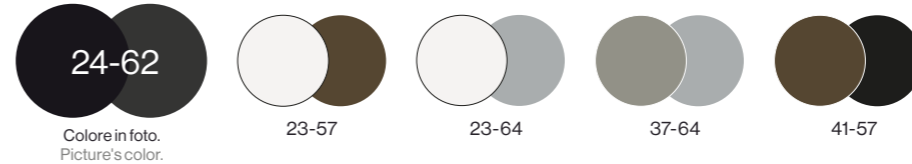

24-62

Colore in foto.  
Picture's color.

23-57

23-64

37-64

41-57

### PLUS

- La robusta e leggera struttura in alluminio ne consente l'uso anche in ambienti marini.  
Very comfortable and light product, also suitable for use in marine contexts.
- L'esclusivo e brevettato sistema di fissaggio delle cinghie ne permette anche la sostituzione.  
The original and patented by EMU fixing system allows to replace the belts in case of damage.
- Comfort elevato grazie al sistema di cinghie intrecciate che ne permette l'uso senza cuscini.  
High comfort thanks to the belts weaving that allows the use without cushions.



# OMBRELLONI SUNSHADES

Ideali per creare con stile zone ombreggiate e protette, gli ombrelloni EMU sono accessori funzionali e pratici. Dotati di un meccanismo che garantisce una facile apertura e chiusura, riducendo lo sforzo necessario alle manovre. Semplici meccanismi a scomparsa permettono di ruotare l'ombrellone sul piano orizzontale e chiuderli agevolmente. Shade Pro, il nuovo prodotto della famiglia Shade, ha come optional un innovativo sistema illuminante a LED e lo si può chiudere senza la necessità di dover spostare gli arredi sottostanti.

EMU sunshades with its functionality and practicality are the perfect accessories for stylish and shaded areas. They have a user-friendly mechanism that makes them easy and hassle-free to open and close. A simple, concealed mechanism allows you to rotate the sunshade horizontally and close it easily. Shade Pro, the new product in the Shade family has an optional, innovative LED lighting system and you can close it without having to move the furniture underneath.

## INDEX

- 292 SHADE ●
- 296 SHADE PRO ●

LEGENDA—LEGEND  
● Acciaio—Steel  
● Alluminio—Aluminium  
● Legno—Wood

# SHADE

Design by Christophe Pillet



Scansiona e scopri i progetti.  
Scan and discover the projects.

980+927  
Ombrellone 2x2  
Sunshade 2x2



982+923  
Ombrellone 3x3  
Sunshade 3x3



Palo: alluminio anodizzato.— Pole: anodised aluminium.  
Telo: tessuti sintetici - poliestere.— Cloth: synthetic fabrics - polyester.  
Struttura basamento: acciaio verniciato.— Base frame: painted steel.  
Cover: tessuto sintetico - poliestere.— Cover: synthetic fabric - polyester.

## PRODOTTI—PRODUCTS



| Codice/Code<br>Tipologia/Typology | Disegno/Drawing | Info |
|-----------------------------------|-----------------|------|
|-----------------------------------|-----------------|------|

**980\***  
Ombrellone 2x2—Sunshade 2x2  
W200 - D200 - H240  
Kg 6,7  
Palo—Pole ø3,8

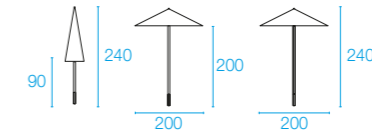

**982\***  
Ombrellone 3x3—Sunshade 3x3  
W300 - D300 - H260  
Kg 17,2  
Palo—Pole ø4,8

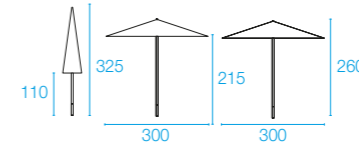

### COLORI PALO/TELO—POLE/CLOTH COLORS



| Codice/Code<br>Tipologia/Typology   | Colori<br>Colors |
|---|------------------|
| <b>923</b><br>Base tonda—Round base<br>x cod. 980, 982<br>ø62 - H1 Kg 25,0                  | 22<br>23         |
| <b>925</b><br>Base tonda—Round base<br>x cod. 980, 982<br>ø62 - H2 Kg 48,0                  | 22<br>23         |
| <b>927</b><br>Base quadrata—Square base<br>x cod. 980, 982<br>W60 - D60 - H4 Kg 29,6        | 23               |
| <b>928</b><br>Base in granito—Granite base<br>x cod. 980, 982<br>W59,5 - D59,5 - H4 Kg 38,0 |                  |
| <b>FC/980</b> Cover x cod. 980  |                  |
| <b>FC/982</b> Cover x cod. 982  |                  |

\*Per il posizionamento degli ombrelloni senza staffaggio ma tramite zavorra vedi tabella riportata a pagina 299.  
For sunshades positioning without brackets but using ballast look at reference table at page 299.

## PLUS

- Giunti e snodi in pressofusione di alluminio verniciato.— Die-cast joints in painted aluminium.
- Apertura per sollevamento e bloccaggio leva inversa x cod. 980.  
Opening for lifting and locking reverse lever x cod. 980.
- Apertura con movimento telescopico. Apertura per sollevamento e bloccaggio su cremagliera dentata x cod. 982.— Opening with telescopic movement. Opening for lifting and locking on toothed rack x cod. 982.

# SHADE

Design by Christophe Pillet



Scansiona e scopri i progetti.  
Scan and discover the projects.

**981+ 929/B6+988**  
Ombrellone 3x3  
Sunshade 3x3



**985+ 929/B8N+988**  
Ombrellone 4x3  
Sunshade 4x3



Palo: alluminio anodizzato o verniciato.—Pole: anodised or painted aluminium.  
Telo: tessuti sintetici - poliestere.—Cloth: synthetic fabrics - polyester.  
Struttura basamento: acciaio verniciato.—Base frame: painted steel.  
Cover: tessuto sintetico - poliestere.—Cover: synthetic fabric - polyester.

## PRODOTTI—PRODUCTS



| Codice/Code<br>Tipologia/Typology | Disegno/Drawing | Info |
|-----------------------------------|-----------------|------|
|-----------------------------------|-----------------|------|

|  |  |  |
|--|--|--|
| <b>981*</b><br>Ombrellone 3x3—Sunshade 3x3<br>W300 - D320 - H272<br>Kg 27,0<br>Palo—Pole ø11 |  |  |
|--|--|--|

|  |  |  |
|--|--|--|
| <b>985*</b><br>Ombrellone 4x3—Sunshade 4x3<br>W400 - D320 - H272<br>Kg 31,0<br>Palo—Pole ø11 |  |  |
|--|--|--|

### COLORI PALO/TELO—POLE/CLOTH COLORS



| Codice/Code<br>Tipologia/Typology  | Colori<br>Colors |
|--|------------------|
| <b>929/B6</b><br>Basamento medio—Medium base<br>x cod. 981 (max. 6 mattonelle—max. 6 tiles)<br>W119 - D54 - H17 Kg 38,0              | 22<br>23         |
| <b>929/B8N</b><br>Basamento grande—Large base<br>x cod. 981, 985 (max. 8 mattonelle—max. 8 tiles)<br>W119 - D58 - H19 Kg 45,0        | 22<br>23         |
| <b>948</b><br>Mattonella in cemento—Cemente tile<br>x cod. 981, 985<br>W50 - D50 - H4 Kg 25,0 (una—each)                             |                  |
| <b>988</b><br>Mattonella in granito con maniglia<br>Granite tile with handle<br>x cod. 981, 985<br>W50 - D50 - H4 Kg 28,5 (una—each) |                  |
| <b>FC/981</b> Cover x cod. 981, 985  |                  |

\*Per il posizionamento degli ombrelloni senza staffaggio ma tramite zavorra vedi tabella riportata a pagina 299.  
For sunshades positioning without brackets but using ballast look at reference table at page 299.

I due modelli 981 e 985 possono essere fissati a terra anche senza ausilio di basamenti.  
Segui le istruzioni sulla relativa pagina prodotto nel sito [www.emu.it](http://www.emu.it).  
The sunshades 981 and 985 can be fastened to the ground without a base.  
Follow the instructions on the relative product page at [www.emu.it](http://www.emu.it).

## PLUS

- 3 posizioni di apertura tramite movimento retrattile.—3 switching positions by retractable movement.
- Girevole (12 posizioni)—Swivel (12 positions).
- Giunti e snodi in pressofusione di alluminio verniciato.—Die-cast joints in painted aluminium.

# SHADE PRO

Design by EMU



Scansiona e scopri i progetti.  
Scan and discover the projects.

995+929/B8N+988  
Ombrellone 3x3  
Sunshade 3x3



996+929/B8N+988  
Ombrellone 4x3  
Sunshade 4x3



Palo: alluminio anodizzato o verniciato.— Pole: anodised or painted aluminium.  
Telo: tessuti sintetici - poliestere.— Cloth: synthetic fabrics - polyester.  
Struttura basamento: acciaio verniciato.— Base frame: painted steel.  
Cover: tessuto sintetico - poliestere.— Cover: synthetic fabric - polyester.

## PRODOTTI—PRODUCTS



| Codice/Code<br>Tipologia/Typology   | Disegno/Drawing | Info |
|---|-----------------|------|
| <b>995*</b><br>Ombrellone 3x3—Sunshade 3x3<br>W303 - D323 - H288<br>Kg 42,5<br>Palo—Pole 9x13,5 |                 |      |
| <b>996*</b><br>Ombrellone 4x3—Sunshade 4x3<br>W403 - D325 - H282<br>Kg 44,1<br>Palo—Pole 9x13,5 |                 |      |

### COLORI PALO/TELO—POLE/CLOTH COLORS

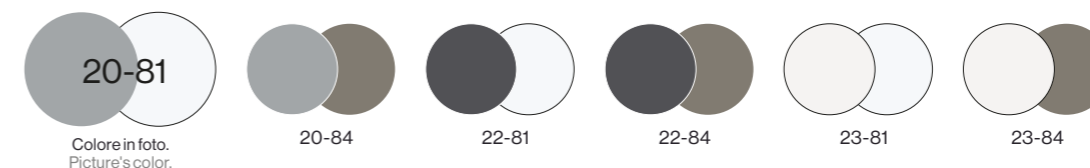

| Codice/Code<br>Tipologia/Typology  | Colori<br>Colors |
|--|------------------|
| <b>999**</b><br>Kit barre led—Led bars kit<br>x cod. 995, 996<br>W1 - D0,3 - H50 (una barra led—each led bar) Kg 2,0 (tot. kit)      |                  |
| <b>992</b><br>Flangia fissaggio a terra—Floor fixing flange<br>x cod. 995, 996<br>ø14,5 - H1 Kg 0,9                                  |                  |
| <b>929/B8N</b><br>Basamento grande—Large base<br>x cod. 995, 996 (max. 8 mattonelle—max. 8 tiles)<br>W119 - D58 - H19 Kg 45,0        |                  |
| <b>948</b><br>Mattonella in cemento—Cemente tile<br>x cod. 995, 996<br>W50 - D50 - H4 Kg 25,0 (una—each)                             |                  |
| <b>988</b><br>Mattonella in granito con maniglia<br>Granite tile with handle<br>x cod. 995, 996<br>W50 - D50 - H4 Kg 28,5 (una—each) |                  |
| <b>FC/981</b> Cover x cod. 995, 996  |                  |

\*I due modelli 995 e 996 possono essere fissati a terra anche senza ausilio di basamenti. Segui le istruzioni sulla relativa pagina prodotto nel sito [www.emu.it](http://www.emu.it). In caso di utilizzo del kit barre LED cod. 999 è necessario aggiungere la flangia cod. 992. Per il posizionamento degli ombrelloni senza staffaggio ma tramite zavorra vedi tabella riportata a pagina 299.  
The sunshades 995 and 996 can be fastened to the ground without a base. Follow the instructions on the relative product page at [www.emu.it](http://www.emu.it). In case of use of the LED bars kit cod. 999 it is necessary to add the flange cod. 992. For sunshades positioning without brackets but using ballast look at reference table at page 299.

\*\*Il kit contiene: n.4 barre led + n.1 telecomando + n.1 centralina (da 230 volt a 24 volt).  
The kit contains: n.4 led bars + n.1 remote control + n.1 power unit (from 230 volt to 24 volt).

# SHADE PRO

Design by EMU



Scansiona e scopri i progetti.  
Scan and discover the projects.

## COD. 995 - APERTURA E CHIUSURA OMBRELLONE—SUNSHADE OPENING AND CLOSING

Vista Frontale—Front View

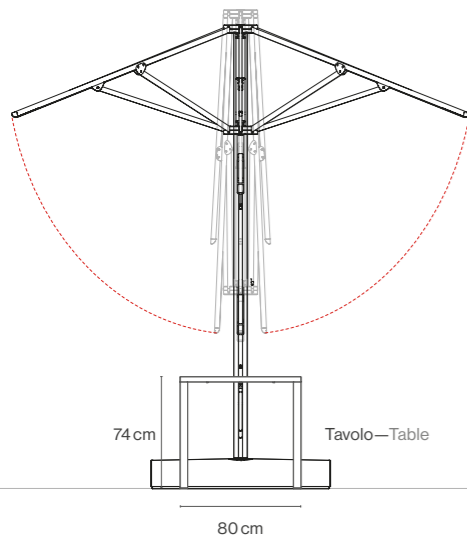

Vista Laterale—Side View

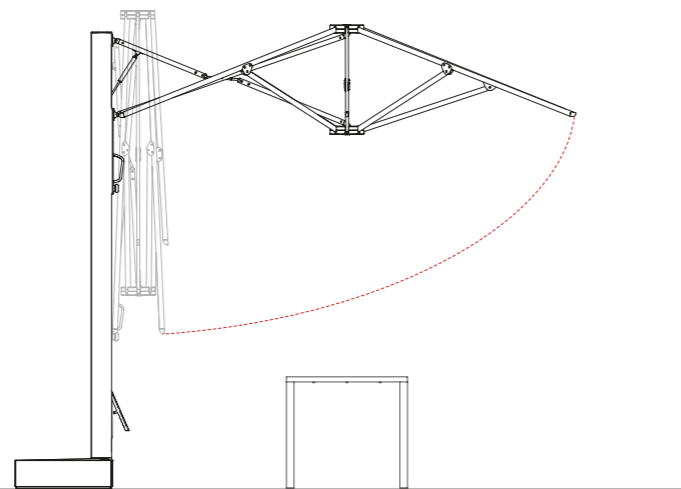

## COD. 996 - APERTURA E CHIUSURA OMBRELLONE—SUNSHADE OPENING AND CLOSING

Vista Frontale—Front View

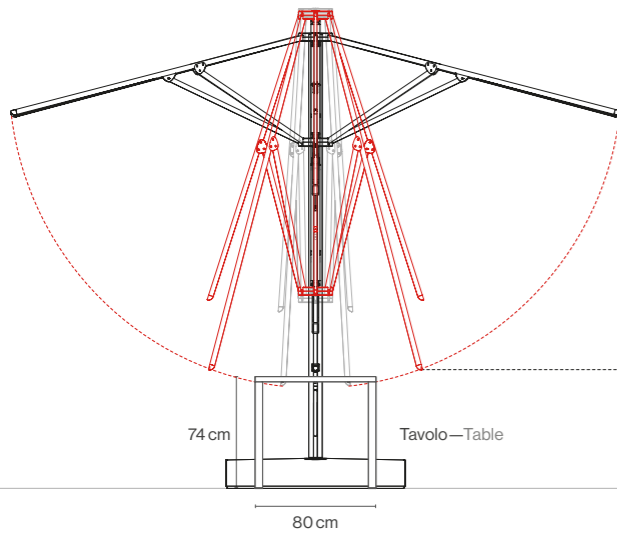

Vista Laterale—Side View

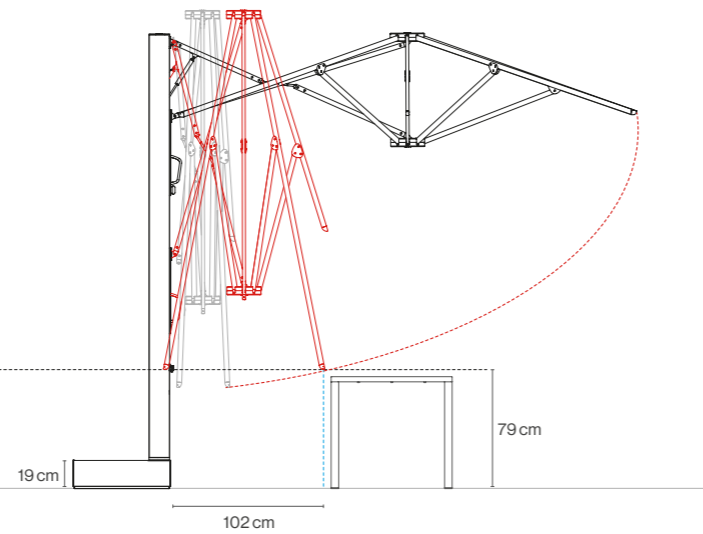

### PLUS

- Ruotabile lateralmente con un semplice meccanismo, autobloccante (12 posizioni).  
Laterally rotatable with a simple self-locking mechanism (12 positions).
- Chiusura facile e veloce.— Quick and easy closure.
- L'apertura e chiusura sono facilitate da una molla a gas e possono essere fatte senza necessità di rimuovere gli arredi sottostanti.— The opening and the closure are facilitated by a gas spring: it could be done without removing the furniture below.
- Optional Kit luci led che si integra perfettamente nella struttura che viene fornita precablata. I cavi di alimentazione passano all'interno del fusto e risultano invisibili.  
Optional kit: the optional led lights integrate perfectly with the frame which is supplied pre-cabled. The power cables pass inside the barrel, in this way they are invisibles.

TABELLA DI RIFERIMENTO PER POSIZIONAMENTO DEGLI OMBRELLONI SENZA STAFFAGGIO MA TRAMITE ZAVORRA - Condizioni di uso: normali - Vento: moderato

| Velocità del vento<br>m/sec                        | Pressione<br>kg/m <sup>2</sup> | Gradi<br>Scala<br>Beaufort | Descrizione       | Prodotti e relative indicazioni per la formazione della zavorra |   |  |  |
|--|--------------------------------|----------------------------|-------------------|---|---|--|--|
|  |                                |                            |                   | SHADE cod. 980  | SHADE cod. 981                                | SHADE cod. 982   | SHADE cod. 985<br>SHADE PRO cod. 995<br>SHADE PRO cod. 996 |
| 0  | 0                              | 0                          | Calma             | ↓   | ↓   | ↓  | ↓  |
| 0,5-1,5  | 0,05                           | 1                          | Bava di vento     | ↓   | ↓   | ↓  | ↓  |
| 2,1-3,1  | 0,39                           | 2                          | Brezza leggera    | ↓   | ↓   | ↓  | ↓  |
| 3,6-5,1  | 1,37                           | 3                          | Brezza tesa       | ↓   | ↓   | ↓  | ↓  |
| 5,5-7,5  | 3,27                           | 4                          | Vento moderato    | <b>25 KG</b>  | <b>100 KG</b>                                 | <b>60 KG</b>   | <b>200 KG</b>  |
| Zavorra consigliata: indicazione per la formazione |                                |                            |                   | Base cod. 923 + 10 kg<br>Cod. 927<br>Cod. 925<br>Cod. 928       | Base cod. 929/B6<br>+ n.6 mattonelle cod. 988 | Base cod. 923 + 40 kg<br>Base cod. 927 + 30 kg<br>Base cod. 925 + 15 kg<br>Base cod. 928 + 20 kg | Base cod. 929/B8<br>+ n.8 mattonelle cod. 988              |
| 8,3-10,3   | 6,39                           | 5                          | Vento teso        | CHIUDERE L'OMBRELLONE   |   |  |  |
| 10,6-13,0  | 11,22                          | 6                          | Vento fresco      |   |   |  |  |
| 13,5-16,6  | 17,58                          | 7                          | Vento forte       |   |   |  |  |
| 17,2-20,1  | 26,36                          | 8                          | Burrasca          | CHIUDERE L'OMBRELLONE E DEPORLO IN ZONE RIPARATE                |   |  |  |
| 20,7-23,6  | 37,59                          | 9                          | Burrasca forte    |   |   |  |  |
| 24,0-27,4  | 51,26                          | 10                         | Tempesta          |   |   |  |  |
| 28,2-32,4  | 68,35                          | 11                         | Tempesta violenta |   |   |  |  |
| OLTRE 33,5   | OLTRE 82                       | 12                         | Uragano           |   |   |  |  |

### DEFINIZIONI STANDARD INTERNAZIONALI DEL GRADO 4 DELLA SCALA BEAUFORT (VENTO MODERATO)

| Gradi Scala Beaufort | Effetti sulla terra   | Effetti sul mare al largo                                   |
|----------------------|---|---|
| 4 Vento moderato     | Vento moderato. Il vento solleva la polvere e i fogli di carta. | Onde piccole che diventano più lunghe. Abbondanti i marosi. |

REFERENCE TABLE FOR POSITIONING SUNSHADES WITHOUT BRACKETS BUT USING BALLAST - Conditions of use: normal - Wind: moderate

| Wind speed<br>in m/sec.                          | Pressure<br>in kg/m <sup>2</sup> | Beaufort<br>scale | Description     | Products and indications for building up ballast          |  |  |  |
|--|----------------------------------|-------------------|-----------------|---|--|--|--|
|  |                                  |                   |                 | SHADE cod. 980  | SHADE cod. 981                               | SHADE cod. 982   | SHADE cod. 985<br>SHADE PRO cod. 995<br>SHADE PRO cod. 996 |
| 0  | 0                                | 0                 | Calm            | ↓   | ↓  | ↓  | ↓  |
| 0,5-1,5  | 0,05                             | 1                 | Light air       | ↓   | ↓  | ↓  | ↓  |
| 2,1-3,1  | 0,39                             | 2                 | Light breeze    | ↓   | ↓  | ↓  | ↓  |
| 3,6-5,1  | 1,37                             | 3                 | Gentle breeze   | ↓   | ↓  | ↓  | ↓  |
| 5,5-7,5  | 3,27                             | 4                 | Moderate breeze | <b>25 KG</b>  | <b>100 KG</b>                                | <b>60 KG</b>   | <b>200 KG</b>  |
| Instructions to make the recommended stabiliser. |                                  |                   |                 | Base code 923 + 10 kg<br>Code 927<br>Code 925<br>Code 928 | Standard cod. 929/B6<br>+ n.6 tiles code 988 | Base code 923 + 40 kg<br>Base code 927 + 30 kg<br>Base code 925 + 15 kg<br>Base code 928 + 20 kg | Standard cod. 929/B8<br>+ n.8 tiles code 988               |
| 8,3-10,3   | 6,39                             | 5                 | Light wind      | CLOSE THE SUNSHADE  |  |  |  |
| 10,6-13,0  | 11,22                            | 6                 | Fresh wind      |   |  |  |  |
| 13,5-16,6  | 17,58                            | 7                 | Strong wind     |   |  |  |  |
| 17,2-20,1  | 26,36                            | 8                 | Gale            | CLOSE THE SUNSHADE AND PUT IT AWAY IN A SHELTERED AREA    |  |  |  |
| 20,7-23,6  | 37,59                            | 9                 | Strong gale     |   |  |  |  |
| 24,0-27,4  | 51,26                            | 10                | Storm           |   |  |  |  |
| 28,2-32,4  | 68,35                            | 11                | Violent storm   |   |  |  |  |
| OVER 33,5  | OVER 82                          | 12                | Hurricane       |   |  |  |  |

### STANDARD INTERNATIONAL DEFINITIONS FOR BEAUFORT SCALE 4 (MODERATE BREEZE)

| Beaufort scale  | Effects on the earth   | Effects on the sea off the coast                 |
|-----------------|--|--|
| 4 Moderate wind | Moderate breeze. The wind raises dust and lifts sheets of paper. | Small waves becoming longer. Plenty of breakers. |



# COMPLEMENTI COMPLEMENTS

Lampade da tavolo ricaricabili con diversi dress code, lampade da terra o a sospensione, sculture suggestive realizzate con moduli assemblabili e corpi illuminanti policromatici, divisori dalle varie geometrie ed altezze e tappeti di diverse fantasie e colori. I complementi d'arredo EMU rispondono a molteplici esigenze d'uso per realizzare raffinate soluzioni di arredo.

The rechargeable table lamps are designed in different styles: floor or suspended lamps, attractive sculptures created with easy-to-assemble modules and multi-colored lighting systems. The EMU furniture complements will meet all your needs and help you create your own sophisticated solution also with panels of varied geometric shapes and heights and colorful patterned carpets.

## INDEX

|     |            |    |
|-----|------------|----|
| 302 | CONE       | ●  |
| 306 | FICUS      | ●  |
| 310 | HEAVEN     | ●  |
| 312 | LUCIOLE    | ●  |
| 314 | PATCHWALL  | ●● |
| 318 | RE-TROUVÉ  | ●  |
| 320 | RED CARPET | ●  |

LEGENDA—LEGEND  
● Acciaio—Steel  
● Alluminio—Aluminium  
● Legno—Wood



# CONE

Design by Chiaramonte—Marin



Scansiona e scopri i progetti.  
Scan and discover the projects.

## 2001 Lampada piccola Small lamp

Luce led 2,3 watt 3000k, max 720 lm.  
Accumulatori al litio ricaricabili da rete.  
Durata batteria 7 ore.  
Ricarica in 9 ore.  
Voltaggio 3,7 V.  
2,3 watt 3000k max 720 lm led light.  
Rechargeable lithium accumulators.  
Battery autonomy: 7 h.  
Battery recharging time: 9 h.  
Voltage 3,7 V.



Dress code 900/93

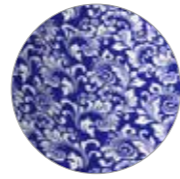

Dress code 900/94

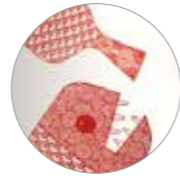

Dress code 900/96



Dress code 900/99

## 2002 Lampada grande Big lamp

Luce led 4,2 watt 3200k, max 629 lm.  
Accumulatori al litio ricaricabili da rete.  
Durata batteria 5 ore.  
Ricarica in 9 ore.  
Voltaggio 3,7 V.  
4,2 watt, 3200k max 629 lm led light.  
Rechargeable lithium accumulators.  
Battery autonomy: 5 h.  
Battery recharging time: 9 h.  
Voltage 3,7 V.



## 2003 Lampada a sospensione Hanging lamp

Alimentazione 230 volt.  
Portalampada E27.  
Power supply 230 volt.  
Lampholder E27.



# PRODOTTI—PRODUCTS



| Codice/Code<br>Tipologia/Typology | Disegno/Drawing | Info |
|-----------------------------------|-----------------|------|
|-----------------------------------|-----------------|------|

|  |  |  |
|--|--|--|
| 2001<br>Lampada piccola<br>Small lamp<br>ø17,5 - H22<br>Kg 0,6 |  |  |
|--|--|--|

|   |  |  |
|---|--|--|
| 2002<br>Lampada grande<br>Big lamp<br>ø47 - H60<br>Kg 3,3 |  |  |
|---|--|--|

|  |  |  |
|--|--|--|
| 2003<br>Lampada a sospensione<br>Hanging lamp<br>ø70 - H72<br>Kg 5,4 |  |  |
|--|--|--|

COLORI STRUTTURA/PARALUME X COD. 2001, 2002—FRAME/LAMPSHADE COLORS X COD. 2001, 2002

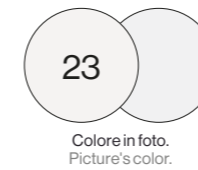

23

Colore in foto.  
Picture's color.

COLORI STRUTTURA/DRESS CODE X COD. 2003—FRAME/DRESS CODE COLORS X COD. 2003

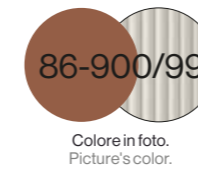

86-900/99

Colore in foto.  
Picture's color.

| Codice/Code<br>Tipologia/Typology                                 | Colori<br>Colors |
|---|------------------|
| DC/2001<br>Dress code poliestere—Polyester dress code x cod. 2001 |                  |
| DC/2002<br>Dress code poliestere—Polyester dress code x cod. 2002 |                  |

## PLUS

• I 4 diversi dress code (disponibili solo per cod. 2001, 2002) rendono il prodotto flessibile ed adeguato a diversi contesti d'uso e stili di arredamento. E' inoltre disponibile l'opzione di personalizzazione del dress code, con una quantità minima di 20 pezzi.

The 4 different dress codes (available only for cod. 2001, 2002) make the product flexible and suitable for many contexts and furnishing styles. Furthermore the option of dress code customization is available, with only 20 pieces as minimum quantity.

# CONE

Design by Chiaramonte—Marin



Scansiona e scopri i progetti.  
Scan and discover the projects.

## 2004+2005 Lampada da terra Floor lamp

Alimentazione 230 volt.  
Portalampana E27.  
Power supply 230 volt.  
Lamp holder E27.



## 2007 Lampada da terra ricaricabile Rechargeable floor lamp

Luce led 4,2 watt  
3200k, max 629 lm.  
Accumulatori al litio ricaricabili da rete.  
Durata batteria 5 ore.  
Ricarica in 9 ore.  
Voltaggio 3,7 V.  
4,2 watt, 3200k max 629 lm led light.  
Rechargeable lithium accumulators.  
Battery autonomy: 5 h.  
Battery recharging time: 9 h.  
Voltage 3,7 V.

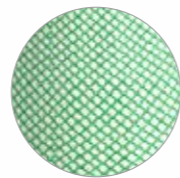

Dress code 900/93

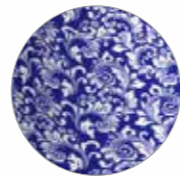

Dress code 900/94

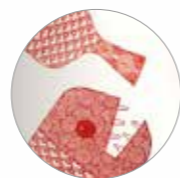

Dress code 900/96



Dress code 900/99

# PRODOTTI—PRODUCTS



| Codice/Code<br>Tipologia/Typology | Disegno/Drawing | Info |
|-----------------------------------|-----------------|------|
|-----------------------------------|-----------------|------|

**2004**  
Lampada da terra  
Floor lamp  
W106 - D229 - H271  
Kg 17,6

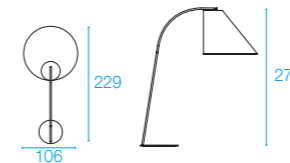

**2007**  
Lampada da terra ricaricabile  
Rechargeable floor lamp  
W43 - D43 - H170  
Kg 10,0

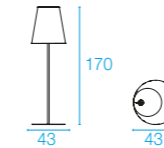

### COLORI STRUTTURA/DRESS CODE X COD. 2004—FRAME/DRESS CODE COLORS X COD. 2004

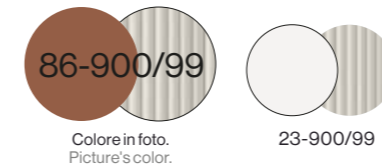

Colore in foto.  
Picture's color.

23-900/99

### COLORI STRUTTURA/PARALUME X COD. 2007—FRAME/LAMPSHADE COLORS X COD. 2007

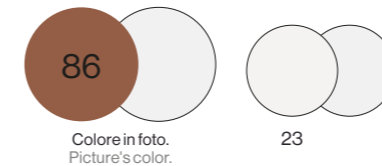

Colore in foto.  
Picture's color.

23

| Codice/Code<br>Tipologia/Typology | Colori<br>Colors |
|-----------------------------------|------------------|
|-----------------------------------|------------------|

**2005**  
Base x cod. 2004  
ø90 - H1 Kg 59,4



**2006**  
Picchetto—Stake x cod. 2004  
ø1,2 - H60 Kg 0,6



**DC/2002**  
Dress code poliestere—Polyester dress code x cod. 2007

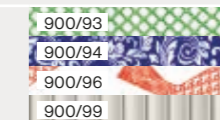

## PLUS

• I 4 diversi dress code (disponibili solo per cod. 2007) rendono il prodotto flessibile ed adeguato a molte condizioni d'uso ma aprono anche alle personalizzazioni, con solo 20 pezzi si può richiedere un dress code personalizzato.

The 4 different dress codes (available only for cod. 2007) make the product flexible and suitable for many conditions of use but also open to customization, with only 20 pieces you can get a custom dresscode request.

• Optional zavorra x cod. 2004.—Ballast on request x cod. 2004.

# FICUS

Design by Chiaramonte—Marin



Scansiona e scopri i progetti.  
Scan and discover the projects.

1230  
Modulo base  
Base module



1231  
Modulo aggiuntivo  
Additional module



## PRODOTTI—PRODUCTS



| Codice/Code<br>Tipologia/Typology   | Disegno/Drawing | Info |
|---|-----------------|------|
| 1230<br>Modulo base<br>Base module<br>W142 - D62,5 - H178,5<br>Kg 53,0          |                 |      |
| 1231<br>Modulo aggiuntivo<br>Additional module<br>W88 - D42,5 - H138<br>Kg 14,0 |                 |      |

### COLORI STRUTTURA—FRAME COLORS



Colore in foto.  
Picture's color.



### PLUS

- Suggestiva ed artistica realizzazione in lamiera stirata prezincata a caldo.  
Suggestive and artistic realization in hot-dip zincated expanded metal sheet.
- Realizzata a moduli assemblabili per avere diverse configurazioni e dimensioni.  
Composed by modules that can be assembled in different configurations and sizes.



Scansiona e scopri i progetti.  
Scan and discover the projects.



1232  
Foglia Jolly  
Jolly leaf



1233  
Frutto  
Fruit



1234+1235  
Lampada contenitore  
con corpo illuminante  
Lamp container  
with lighting device



## PRODOTTI—PRODUCTS

| Codice/Code<br>Tipologia/Typology   | Disegno/Drawing | Info |
|---|-----------------|------|
| 1232<br>Foglia Jolly<br>Jolly leaf<br>W38 - D9,5 - H49<br>Kg 2,8            |                 |      |
| 1233<br>Frutto<br>Fruit<br>W8,5 - D8 - H15<br>Kg 0,4                        |                 |      |
| 1234<br>Lampada contenitore<br>Lamp container<br>W71 - D58 - H28<br>Kg 13,5 |                 |      |

### COLORI STRUTTURA X COD. 1232—FRAME COLORS X COD. 1232

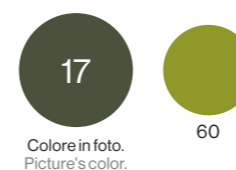

### COLORI STRUTTURA X COD. 1233—FRAME COLORS X COD. 1233

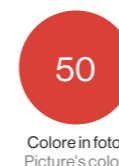

### COLORI STRUTTURA X COD. 1234—FRAME COLORS X COD. 1234

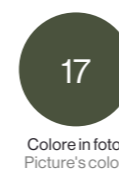

Codice/Code  
Tipologia/Typology

1235  
Corpo illuminante—Lighting device  
ø20 Kg 0,4

Luce led 5 watt 6000k.  
20-500 lumen dimmerabili + altri 15 colori dimmerabili con telecomando. Accumulatori al litio ricaricabili da rete. Durata batteria 8/12 ore. Ricarica in 4 ore. Voltaggio 4,2 V.  
5 watt led light 6000k.  
20-500 lumen dimmable + other 15 dimmable colors with remote control. Rechargeable lithium accumulators. Battery autonomy: 8/12 h. Battery recharging time: 4 h. Voltage 4,2 V.





Scansiona e scopri  
i progetti.  
Scan and discover  
the projects.

497  
Vaso alto  
Tall vase

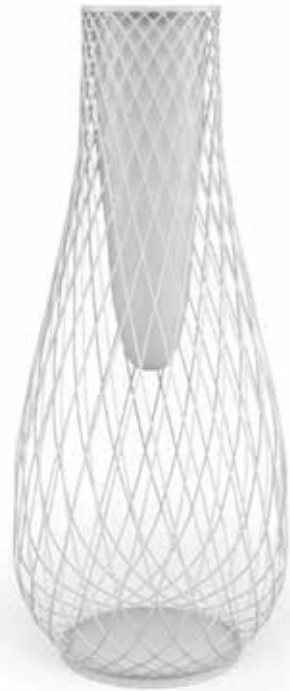

498  
Vaso basso  
Short vase

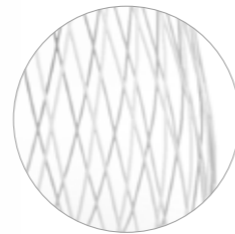

Sinuoso reticolo di tondini zincati  
crea classiche forme affascinanti.  
Sinuous grid of zincated bars  
that create classic fascinating  
shapes.

## PRODOTTI—PRODUCTS

| Codice/Code<br>Tipologia/Typology | Disegno/Drawing | Info |
|-----------------------------------|-----------------|------|
|-----------------------------------|-----------------|------|

497

Vaso alto  
Tall vase  
ø68 - H163  
Kg 23,2

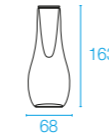

498

Vaso basso  
Short vase  
ø60 - H103  
Kg 20,4

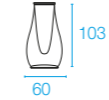

### COLORI STRUTTURA—FRAME COLORS



Colore in foto.  
Picture's color.

### PLUS

- Rete zincata a caldo.—Hot-dip zincated mesh.
- Saldatura a proiezione della rete alla struttura in tubolare che conferisce un migliore effetto estetico.  
Spot welding of the mesh to the tubular frame which gives a better aesthetic effect.



Scansiona e scopri i progetti.  
Scan and discover the projects.

## 2010 Lampada piccola Small lamp

Luce led 1,5 watt 3000k dimmerabile.  
Accumulatori al litio ricaricabili da rete.  
Durata batteria 8 ore.  
Ricarica in 9 ore.  
1,5 watt 3000k dimmerable led light.  
Rechargeable lithium accumulators.  
Battery autonomy: 8 h.  
Battery recharging time: 9 h.



## 2011+2010 Lampada con picchetto piccolo Lamp with short spike



## 2012+2010 Lampada con picchetto medio Lamp with medium spike



## 2013+2010 Lampada con picchetto alto Lamp with tall spike



## PRODOTTI—PRODUCTS

| Codice/Code<br>Tipologia/Typology  | Disegno/Drawing | Info |
|--|-----------------|------|
| 2010*<br>Lampada piccola<br>Small lamp<br>W10,5 - D10,5 - H30<br>Kg 0,33 |                 | <br> |
| 2011<br>Picchetto piccolo<br>Short spike<br>ø2 - H53<br>Kg 0,3           |                 |      |
| 2012<br>Picchetto medio<br>Medium spike<br>ø2 - H83<br>Kg 0,5            |                 |      |
| 2013<br>Picchetto alto<br>Tall spike<br>ø2 - H133<br>Kg 0,8              |                 |      |

\*Corpo illuminante con tappo USB removibile. Interruttore on-off a sfioramento.  
Base dotata di un magnete per favorire la stabilità su superfici in metallo.  
\*Lighting device with removable USB lid. Soft touch on-off switch.  
Base with a magnet to ensure a more stabile standing on metal table tops.

### COLORI STRUTTURA X COD. 2010—FRAME COLORS X COD. 2010

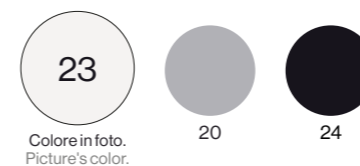

### COLORI STRUTTURA X COD. 2011, 2012, 2013—FRAME COLORS X COD. 2011, 2012, 2013

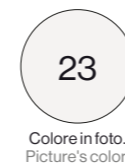

## PLUS

- Led ricaricabile integrato nella testa della luce.— Built-in rechargeable led.
- Base magnetica.— Magnetic base.
- Corpo illuminante rimovibile.— Removable luminaire.
- 3 possibili usi: lampada da tavolo, torcia, fissata a terra.— 3 possible uses: table lamp, torch, fixed to the ground.

# PATCHWALL

Design by Chiaramonte—Marin



Scansiona e scopri i progetti.  
Scan and discover the projects.

**2020**  
Pannello lamiera piena  
Full metal sheet panel



**2021**  
Pannello HPL  
HPL panel



**2022**  
Pannello vetro  
Glass panel



**2023**  
Pannello lamiera emotion  
Emotion metal sheet panel



**2024**  
Pannello alluminio e vetro  
Aluminium and glass panel



Struttura: alluminio verniciato.—Frame: painted aluminium.  
Pannelli: acciaio verniciato o HPL o cristallo temperato o alluminio verniciato.  
Panels: painted steel or HPL or tempered glass or painted aluminium.  
Basi: acciaio verniciato.—Bases: painted steel.  
Angolari: alluminio verniciato.—Angulars: painted aluminium.

## PRODOTTI—PRODUCTS



| Codice/Code<br>Tipologia/Typology   | Disegno/Drawing | Info |
|---|-----------------|------|
| <b>2020</b><br>Pannello lamiera piena— Full metal panel<br>W83,5 - D83,5 - H8 Kg 10,3             |                 |      |
| <b>2021</b><br>Pannello HPL—HPL panel<br>W83,5 - D83,5 - H8 Kg 11,6                               |                 |      |
| <b>2022</b><br>Pannello vetro—Glass panel<br>W83,5 - D83,5 - H8 Kg 14,6                           |                 |      |
| <b>2023</b><br>Pannello lamiera emotion—Emotion metal sheet panel<br>W83,5 - D83,5 - H8 Kg 9,8    |                 |      |
| <b>2024</b><br>Pannello alluminio e vetro—Aluminium and glass panel<br>W83,5 - D83,5 - H8 Kg 13,4 |                 |      |

COLORI STRUTTURA/PANNELLO X COD. 2020, 2021, 2023—FRAME/PANEL COLORS X COD. 2020, 2021, 2023

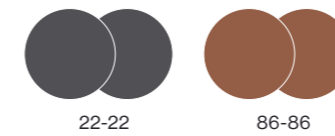

COLORI STRUTTURA/PANNELLO X COD. 2022—FRAME/PANEL COLORS X COD. 2022

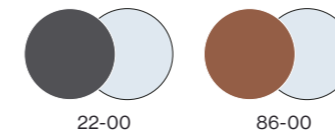

COLORI STRUTTURA/VETRO/PANNELLO X COD. 2024—FRAME/GLASS/PANEL COLORS X COD. 2024



| Codice/Code<br>Tipologia/Typology   | Colori<br>Colors |
|---|------------------|
| <b>2030</b><br>Base regolabile—Adjustable base<br>x cod. 2020, 2021, 2022, 2023, 2024<br>W42 - D12 - H5/8 Kg 2,6  | 22<br>86         |
| <b>2031</b><br>Base fissa—Fixed base<br>x cod. 2020, 2021, 2022, 2023, 2024<br>W8 - D12 - H5/8 Kg 0,6   | 22<br>86         |
| <b>2038</b><br>Struttura angolare altezza singola fissa<br>Single height angular frame<br>x cod. 2020, 2021, 2022, 2023, 2024<br>W8 - D8 - H89,5 Kg 1,8 | 22<br>86         |
| <b>2039</b><br>Struttura angolare altezza doppia<br>Double height angular frame<br>x cod. 2020, 2021, 2022, 2023, 2024<br>W8 - D8 - H173 Kg 3,4         | 22<br>86         |



Scansiona e scopri i progetti.  
Scan and discover the projects.



2040  
Fioriera alta  
Tall flower box



2041  
Fioriera media  
Medium flower box



2042  
Fioriera bassa  
Short flower box



## PRODOTTI—PRODUCTS

| Codice/Code<br>Tipologia/Typology   | Disegno/Drawing | Info |
|---|-----------------|------|
| 2040<br>Fioriera alta<br>Tall flower box<br>W21 - D32 - H87,5<br>Kg 13,2    |                 |      |
| 2041<br>Fioriera media<br>Medium flower box<br>W83,5 - D32 - H64<br>Kg 22,6 |                 |      |
| 2042<br>Fioriera bassa<br>Short flower box<br>W83,5 - D32 - H25<br>Kg 11,8  |                 |      |

### COLORI STRUTTURA—FRAME COLORS

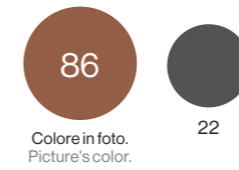

### PLUS

- Combinazione di più materiali.—Multi-material collection.
- Permette di realizzare varie combinazioni alternando sia moduli diversi sia realizzando geometrie ed altezze diverse.—It allows to realize different combinations either by adding various modules or by realizing different geometries and heights.
- Struttura in estruso di lega di alluminio.—Extruded aluminium alloy frame.
- Piedi regolabili.—Adjustable feet.
- Piano in lamiera zincata.—Hot-dip zinned sheet.
- Drenaggio acqua da fioriere.—Water drainage from flower boxes.



# RE-TROUVÉ

Design by Patricia Urquiola



Scansiona e scopri i progetti.  
Scan and discover the projects.

577+580  
Vaso alto  
Tall vase

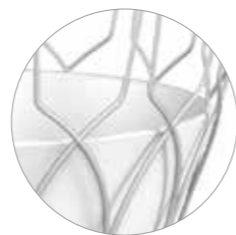

Vaso in ceramica con foro scolo acqua.  
Ceramic vase with bottom hole for water drainage.

578+580  
Vaso basso  
Short vase

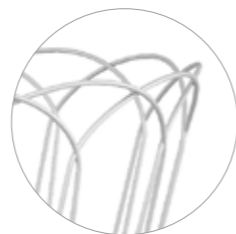

Tondino di acciaio zincato piegato con macchine a controllo numerico, per una maggiore precisione ed un migliore controllo del processo produttivo.  
Hot-dip zincated steel bar bent with numerical control machines for a more precise and accurate manufacturing process.

## PRODOTTI—PRODUCTS



| Codice/Code<br>Tipologia/Typology | Disegno/Drawing | Info |
|-----------------------------------|-----------------|------|
|-----------------------------------|-----------------|------|

577

Vaso alto  
Tall vase  
ø72 - H105  
Kg 9,4

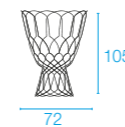

578

Vaso basso  
Short vase  
ø65 - H71  
Kg 7,4

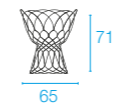

### COLORI STRUTTURA—FRAME COLORS

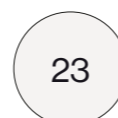

Colore in foto.  
Picture's color.

| Codice/Code<br>Tipologia/Typology | Info | Colori<br>Colors |
|-----------------------------------|------|------------------|
|-----------------------------------|------|------------------|

580

Fioriera—Flower box  
x cod. 577, 578  
ø60 - H37 Kg 15,0



23

# RED CARPET

Design by EMU



Scansiona e scopri i progetti.  
Scan and discover the projects.

3001  
Tappeto  
Rug



3002  
Tappeto  
Rug



## PRODOTTI—PRODUCTS

| Codice/Code<br>Tipologia/Typology | Disegno/Drawing | Info |
|-----------------------------------|-----------------|------|
|-----------------------------------|-----------------|------|

3001

Tappeto  
Rug  
W200 - D300 - H1  
Kg 12,0



3002

Tappeto  
Rug  
W300 - D400 - H1  
Kg 24,0



### COLORI TAPPETO/BORDO—RUG/BORDER COLORS

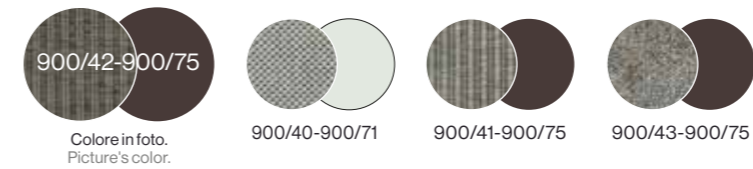

900/42-900/75

900/40-900/71

900/41-900/75

900/43-900/75

## PLUS

• Realizzati in polipropilene, questi tappeti sono lavabili, duraturi ed offrono fantasie e colori che possono soddisfare le più diverse esigenze di arredi. Due dimensioni disponibili.

Composed by polypropylene, these rugs are washable, long-lasting and many patterns and colors are available in order to furnish any context. Two sizes available.



# CUSCINI CUSHIONS

Realizzati con materiali altamente performanti ed estremamente resistenti agli agenti atmosferici, i cuscini EMU sono facilmente sfoderabili e lavabili, idrorepellenti, antiscivolo, con vari sistemi di fissaggio e adattabili a diverse tipologie di seduta. Disponibili in varie forme, colori, varietà di trame, motivi e texture, permettono di offrire massimo comfort e creare eleganti soluzioni di arredo.

With high-performance and extremely weather-resistant materials, EMU cushions are easily removable and washable, water-repellent, non-slip, with various fastening systems and suitable for different types of seating. Available in various shapes, colors, variety of weaves, patterns and textures, they offer maximum comfort and create elegant furnishing solutions.

---

## INDEX

- 324 DECORATIVE CUSHIONS
- 326 EMU CUSHIONS
- 327 MAGNETIC CUSHIONS
- 328 UNIVERSAL CUSHIONS

# DECORATIVE CUSHIONS

Design by EMU



| Codice/Code<br>Tipologia/Typology   | Info | Colori<br>Colors | Categoria tessuto<br>Fabric category  |
|---|------|------------------|---|
| <b>C/701</b><br>Cuscino decorativo—Decorative cushion<br>W40 - D40 - H15 Kg 0,7 |      |                  | Tessuti Basic (Vedi riepilogo pg. 325)<br>Tessuti Standard (Vedi riepilogo pg. 325)<br>Tessuti Premium (Vedi riepilogo pg. 325)<br>Basic Fabrics (Look at pg. 325)<br>Standard Fabrics (Look at pg. 325)<br>Premium Fabrics (Look at pg. 325) |
| <b>C/705</b><br>Cuscino decorativo—Decorative cushion<br>W45 - D35 - H15 Kg 0,6 |      |                  |   |
| <b>C/706</b><br>Cuscino decorativo—Decorative cushion<br>W60 - D40 - H20 Kg 0,8 |      |                  |   |

## CUSCINI DECORATIVI PER COLLEZIONI—DECORATIVE CUSHIONS FOR COLLECTION

| Collezione<br>Collection | Cod. | Tipologia<br>Typology                           |   |   |   |
|--------------------------|------|---|---|---|---|
| ATHENA                   | 3416 | Poltrona<br>Lounge chair                        | • | • | • |
|                          | 3417 | Divano<br>Sofa                                  | • | • | • |
| CANNOLÈ                  | 1080 | Poltrona<br>Lounge chair                        | • | • | • |
|                          | 1081 | Modulo lineare<br>Straight module               | • | • | • |
|                          | 1082 | Modulo terminale dx<br>Right end module         | • | • | • |
|                          | 1083 | Modulo terminale sx<br>Left end module          | • | • | • |
|                          | 1084 | Modulo angolare<br>Corner module                | • | • | • |
| CAROUSEL                 | 1216 | Poltrona<br>Lounge chair                        | • | • | • |
|                          | 1217 | Poltrona<br>Lounge chair                        | • | • | • |
|                          | 1218 | Poltrona<br>Lounge chair                        | • | • | • |
|                          | 1219 | Divano<br>Sofa                                  | • | • | • |
|                          | 1204 | Poltrona<br>Lounge chair                        | • | • | • |
| COMO                     | 1205 | Divano<br>Sofa                                  | • | • | • |
|                          | 421  | Poltrona<br>Lounge chair                        | • | • | • |
| CROSS                    | 422  | Divano<br>Sofa                                  | • | • | • |
|                          | 744  | Poltrona<br>Lounge chair                        | • | • | • |
| DOCK                     | 742  | Struttura divano 2 posti<br>2-seater sofa frame | • | • | • |
|                          | 743  | Struttura divano 3 posti<br>3-seater sofa frame | • | • | • |

| Collezione<br>Collection | Cod. | Tipologia<br>Typology                           |   |   |   |
|--------------------------|------|---|---|---|---|
| HEAVEN                   | 487  | Poltrona<br>Lounge chair                        | • | • | • |
| IVY                      | 585  | Poltrona<br>Lounge chair                        | • | • | • |
|                          | 586  | Divano<br>Sofa                                  | • | • | • |
| ROUND                    | 469  | Poltrona<br>Lounge chair                        | • | • | • |
| TAMI                     | 763  | Struttura poltrona<br>Lounge chair frame        | • | • | • |
|                          | 764  | Struttura divano 2 posti<br>2-seater sofa frame | • | • | • |
|                          | 765  | Struttura divano 3 posti<br>3-seater sofa frame | • | • | • |
|                          | 769  | Struttura angolare<br>Angular frame             | • | • | • |
|                          | 729  | Struttura poltrona<br>Lounge chair frame        | • | • | • |
| TERRAMARE                | 730  | Struttura divano 2 posti<br>2-seater sofa frame | • | • | • |
|                          | 731  | Struttura divano 3 posti<br>3-seater sofa frame | • | • | • |

# TESSUTI CUSCINI DECORATIVI C/701 - C/705 - C/706 DECORATIVE CUSHIONS FABRICS C/701 - C/705 - C/706

| Composizione/Categoria tessuti<br>Composition/Fabrics category | Colori<br>Colors |
|--|------------------|
|--|------------------|

## TESSUTI BASIC—BASIC FABRICS

|                  |        |
|------------------|--------|
| Acrilico—Acrylic | 700/4  |
|                  | 700/10 |
|                  | 700/12 |
|                  | 700/13 |
|                  | 700/14 |

## TESSUTI STANDARD—STANDARD FABRICS

|  |        |
|--|--------|
| 85% Polipropilene, 15% Poliestere—85% Polypropylene, 15% Polyester | 900/01 |
|  | 900/02 |
|  | 900/03 |
|  | 900/05 |
|  | 900/06 |
|  | 900/07 |
|  | 900/08 |
|  | 900/09 |
|  | 900/13 |
|  | 900/14 |
| Acrilico—Acrylic   | 900/17 |
|  | 900/18 |
| Polipropilene—Polypropylene  | 900/71 |
|  | 900/75 |
|  | 900/77 |
|  | 900/79 |

## TESSUTI PREMIUM—PREMIUM FABRICS

|  |        |
|--|--------|
| CAT. D<br>Visitare il nostro sito web <a href="http://www.emu.it">www.emu.it</a> —Visit our website <a href="http://www.emu.it">www.emu.it</a> | 600/08 |
|  | 600/09 |
|  | 600/15 |
|  | 600/17 |
|  | 600/24 |
|  | 600/25 |
|  | 600/26 |
|  | 600/27 |
|  | 600/28 |
|  | 900/16 |
| 900/19   |        |
| CAT. C<br>Visitare il nostro sito web <a href="http://www.emu.it">www.emu.it</a> —Visit our website <a href="http://www.emu.it">www.emu.it</a> | 600/02 |
|  | 600/07 |
|  | 600/14 |
|  | 600/16 |
|  | 600/18 |
| CAT. B<br>Visitare il nostro sito web <a href="http://www.emu.it">www.emu.it</a> —Visit our website <a href="http://www.emu.it">www.emu.it</a> | 600/03 |
|  | 600/10 |
|  | 600/11 |
|  | 600/12 |
|  | 600/22 |
| CAT. A<br>Visitare il nostro sito web <a href="http://www.emu.it">www.emu.it</a> —Visit our website <a href="http://www.emu.it">www.emu.it</a> | 600/04 |
|  | 600/06 |
|  | 600/21 |
|  | 600/21 |

## CON TESSUTO CLIENTE—WITH CUSTOMER'S FABRIC

|  |  |
|--|--|
| FABBISOGNO TESSUTO (cm)—FABRIC REQUIRED (cm) | C/701 132x40, C/705 132x40, C/706 132x60 |
|--|--|

Ⓢ La caratteristica FLAME RETARDANT indica una capacità di resistenza contro fonti di calore o fuoco. Per conoscere nel dettaglio tale caratteristica si prega di far riferimento alle schede tecniche presenti nell'area riservata del sito [www.emu.it](http://www.emu.it). The FLAME RETARDANT characteristic is an indication of chemical resistance against sources of heat or fire. To find out more about this feature, please refer to the technical data sheets in the reserved area of the website [www.emu.it](http://www.emu.it).

## I CUSCINI DECORATIVI HANNO LA FODERA INTERNA IN POLIESTERE

Fodera utilizzata solo per i cuscini decorativi. Si intende una fodera in poliestere dell'imbottitura interna senza nessuna protezione all'acqua, a solo scopo contenitivo dell'imbottitura interna.

## DECORATIVE CUSHIONS HAVE A POLYESTER INNER LINING

Lining used only for decorative cushions. It is a non-waterproof polyester lining only containing the inner padding.

| Collezione<br>Collection | Cod.  | Tipologia<br>Typology                                     | Cuscini con tessuti Basic<br>Cushion with Basic fabric                         |  | Cuscini con tessuti Standard e Premium<br>Cushion with Standard and Premium fabric |  |
|--------------------------|-------|---|--|--|--|--|
|                          |       |   | NON ha fodera interna,<br>solo imbottitura<br>NO inner lining,<br>only padding | Fodera in poliestere<br>Polyester lining | NON ha fodera interna,<br>solo imbottitura<br>NO inner lining,<br>only padding     | Fodera in poliestere<br>Polyester lining |
| DECORATIVE<br>CUSHIONS   | C/701 | Cuscino quadrato<br>Square cushion                        |  | •  |  | •  |
|                          | C/705 | Cuscino rettangolare piccolo<br>Small rectangular cushion |  | •  |  | •  |
|                          | C/706 | Cuscino rettangolare grande<br>Big rectangular cushion    |  | •  |  | •  |

# EMU CUSHIONS

Design by EMU



| Codice/Code<br>Tipologia/Typology   | Info | Colori<br>Colors | Categoria tessuto<br>Fabric category |
|---|------|------------------|--------------------------------------|
| <b>C/703</b><br>Cuscino EMU acrilico quadrato<br>Acrylic EMU square cushion<br>W38 - D38 - H2 Kg 0,13 |      | 700/4            | Tessuti Basic<br>Basic Fabrics       |
|   |      | 700/10           |                                      |
|   |      | 700/12           |                                      |
|   |      | 700/13           |                                      |
|   |      | 700/14           |                                      |
| <b>C/704</b><br>Cuscino EMU acrilico tondo<br>Acrylic EMU round cushion<br>ø38,5 - H2 Kg 0,11         |      | 700/4            | Tessuti Basic<br>Basic Fabrics       |
|   |      | 700/10           |                                      |
|   |      | 700/12           |                                      |
|   |      | 700/13           |                                      |
|   |      | 700/14           |                                      |

## CUSCINI EMU PER COLLEZIONI—EMU CUSHIONS FOR COLLECTION

| Collezione<br>Collection | Cod. | Tipologia<br>Typology             |       |       |
|--------------------------|------|-----------------------------------|-------|-------|
|                          |      |                                   | C/703 | C/704 |
| CAPRERA                  | 930  | Sedia<br>Chair                    |       | •     |
|                          | 931  | Poltroncina<br>Armchair           |       | •     |
| MIA                      | 410  | Sedia<br>Chair                    | •     |       |
|                          | 411  | Poltroncina<br>Armchair           | •     |       |
|                          | 412  | Sgabello<br>Barstool              | •     |       |
| PIGALLE                  | 909  | Sedia<br>Chair                    |       | •     |
|                          | 910  | Poltroncina<br>Armchair           |       | •     |
|                          | 924  | Sedia pieghevole<br>Folding chair |       | •     |
| SEGNO                    | 263  | Sedia<br>Chair                    | •     |       |
|                          | 264  | Sgabello<br>Barstool              | •     |       |
|                          | 268  | Poltroncina<br>Armchair           | •     |       |

| Collezione<br>Collection | Cod. | Tipologia<br>Typology   |       |       |
|--------------------------|------|-------------------------|-------|-------|
|                          |      |                         | C/703 | C/704 |
| SOLE                     | 3402 | Sedia<br>Chair          |       | •     |
|                          | 3403 | Poltroncina<br>Armchair |       | •     |
| STAR                     | 161  | Sedia<br>Chair          | •     |       |
|                          | 162  | Poltroncina<br>Armchair | •     |       |
|                          | 164  | Sgabello<br>Barstool    | •     |       |
| URBAN                    | 208  | Sedia<br>Chair          | •     |       |
|                          | 209  | Poltroncina<br>Armchair | •     |       |
|                          | 211  | Sgabello<br>Barstool    | •     |       |

## CARATTERISTICHE CUSCINI EMU—EMU CUSHIONS CHARACTERISTICS

| Collezione<br>Collection | Cod.  | Tipologia<br>Typology                      | Cuscini con tessuti Basic<br>Cushion with Basic fabric                         |  |
|--------------------------|-------|--|--|--|
|                          |       |  | NON ha fodera interna,<br>solo imbottitura<br>NO inner lining,<br>only padding | Fodera in poliestere<br>Polyester lining |
| EMU CUSHIONS             | C/703 | Cuscino EMU quadrato<br>EMU square cushion | •  |  |
|                          | C/704 | Cuscino EMU tondo<br>EMU round cushion     | •  |  |

# MAGNETIC CUSHIONS

Design by Chiaramonte—Marin



| Codice/Code<br>Tipologia/Typology  | Info | Colori<br>Colors | Categoria tessuto<br>Fabric category |
|--|------|------------------|--------------------------------------|
| <b>C/710</b><br>Cuscino magnetico EMU-TEX quadrato<br>EMU-TEX square magnetic cushion<br>W39 - D37 - H1,5 Kg 0,23          |      | 300/10           | EMU-TEX<br>EMU-TEX                   |
|  |      | 300/11           |                                      |
|  |      | 300/12           |                                      |
|  |      | 300/13           |                                      |
| <b>C/711</b><br>Cuscino magnetico EMU-TEX tondo<br>EMU-TEX round magnetic cushion<br>ø38 - H1,5 Kg 0,17                    |      | 300/10           | EMU-TEX<br>EMU-TEX                   |
|  |      | 300/11           |                                      |
|  |      | 300/12           |                                      |
|  |      | 300/13           |                                      |
| <b>C/712</b><br>Cuscino magnetico EMU-TEX rettangolare<br>EMU-TEX rectangular magnetic cushion<br>W40 - D28 - H1,5 Kg 0,18 |      | 300/10           | EMU-TEX<br>EMU-TEX                   |
|  |      | 300/11           |                                      |
|  |      | 300/12           |                                      |
|  |      | 300/13           |                                      |
|  |      | 300/14           |                                      |
| <b>C/713</b><br>Cuscino magnetico EMU-TEX poltrona<br>EMU-TEX lounge chair magnetic cushion<br>W53 - D44 - H1,5 Kg 0,3     |      | 300/10           | EMU-TEX<br>EMU-TEX                   |
|  |      | 300/11           |                                      |
|  |      | 300/12           |                                      |
|  |      | 300/15           |                                      |

## CUSCINI MAGNETICI PER COLLEZIONI—MAGNETIC CUSHIONS FOR COLLECTION

| Collezione<br>Collection | Cod. | Tipologia<br>Typology             |       |       |       |       | Collezione<br>Collection | Cod.                              | Tipologia<br>Typology          |                      |       |       |       |  |
|--------------------------|------|-----------------------------------|-------|-------|-------|-------|--------------------------|-----------------------------------|--------------------------------|----------------------|-------|-------|-------|--|
|                          |      |                                   | C/710 | C/711 | C/712 | C/713 |                          |                                   |                                | C/710                | C/711 | C/712 | C/713 |  |
| AERO                     | 024  | Sgabello<br>Barstool              |       |       | •     |       | 795                      | Poltrona dondolo<br>Rocking chair |                                |                      |       |       | •     |  |
|                          | 027  | Sedia<br>Chair                    |       |       | •     |       |                          | SEGNO                             | 263                            | Sedia<br>Chair       | •     |       |       |  |
|                          | 023  | Poltrona<br>Lounge chair          |       |       |       | •     |                          |                                   | 264                            | Sgabello<br>Barstool | •     |       |       |  |
| ALA                      | 150  | Sedia<br>Chair                    | •     |       |       |       | 268                      | Poltroncina<br>Armchair           | •                              |                      |       |       |       |  |
|                          | 151  | Poltroncina<br>Armchair           | •     |       |       |       | SOLE                     | 3402                              | Sedia<br>Chair                 |                      | •     |       |       |  |
| ARCENCIEL                | 314  | Sedia<br>Chair                    |       |       | •     |       |                          | 3403                              | Poltroncina<br>Armchair        |                      | •     |       |       |  |
| CAPRERA                  | 930  | Sedia<br>Chair                    |       | •     |       |       | STAR                     | 161                               | Sedia<br>Chair                 | •                    |       |       |       |  |
|                          | 931  | Poltroncina<br>Armchair           |       | •     |       |       |                          | 162                               | Poltroncina<br>Armchair        | •                    |       |       |       |  |
| PIGALLE                  | 909  | Sedia<br>Chair                    |       | •     |       |       | 164                      | Sgabello<br>Barstool              | •                              |                      |       |       |       |  |
|                          | 910  | Poltroncina<br>Armchair           |       | •     |       |       | 165                      | Poltrona<br>Lounge chair          |                                |                      |       | •     |       |  |
|                          | 924  | Sedia pieghevole<br>Folding chair |       | •     |       |       | 166                      | Divano<br>Sofa                    |                                |                      |       | •     |       |  |
| RIOR50                   | 790  | Sedia<br>Chair                    | •     |       |       |       | THOR                     | 655                               | Sedia<br>Chair                 |                      | •     |       |       |  |
|                          | 791  | Poltroncina<br>Armchair           | •     |       |       |       |                          | 657                               | Sgabello<br>Barstool           |                      | •     |       |       |  |
|                          | 793  | Sgabello<br>Barstool              |       |       | •     |       |                          | 658                               | Sgabello basso<br>Dining stool |                      | •     |       |       |  |
|                          | 792  | Poltrona<br>Lounge chair          |       |       |       | •     |                          |                                   |                                |                      |       |       |       |  |

# UNIVERSAL CUSHIONS (Water-repellent fabrics)

Design by EMU



| Codice/Code<br>Tipologia/Typology   | Info | Colori<br>Colors | Categoria tessuto<br>Fabric category                  |
|---|------|------------------|---|
| <b>C/707</b><br>Cuscino universale poliester<br>Polyester universal cushion<br>W44 - D38 - H2 Kg 0,23 |      | 500/28           | Tessuti Cuscini Contract<br>Contract Cushions Fabrics |
|   |      | 500/29           |   |
|   |      | 500/30           |   |
|   |      | 500/31           |   |
|   |      | 500/51           |   |
| <b>C/708</b><br>Cuscino universale poliester<br>Polyester universal cushion<br>W43 - D43 - H2 Kg 0,23 |      | 500/28           | Tessuti Cuscini Contract<br>Contract Cushions Fabrics |
|   |      | 500/29           |   |
|   |      | 500/30           |   |
|   |      | 500/31           |   |
|   |      | 500/51           |   |
| <b>C/709</b><br>Cuscino universale poliester<br>Polyester universal cushion<br>W37 - D37 - H2 Kg 0,17 |      | 500/28           | Tessuti Cuscini Contract<br>Contract Cushions Fabrics |
|   |      | 500/29           |   |
|   |      | 500/30           |   |
|   |      | 500/31           |   |
|   |      | 500/51           |   |
| <b>C/716</b><br>Cuscino universale poliester<br>Polyester universal cushion<br>W40 - D38 - H2 Kg 0,19 |      | 500/28           | Tessuti Cuscini Contract<br>Contract Cushions Fabrics |
|   |      | 500/29           |   |
|   |      | 500/30           |   |
|   |      | 500/31           |   |
|   |      | 500/51           |   |

## CUSCINI UNIVERSALI PER COLLEZIONI—UNIVERSAL CUSHIONS FOR COLLECTION

| Collezione<br>Collection | Cod. | Tipologia<br>Typology   |   |   |   |   | Collezione<br>Collection | Cod.                              | Tipologia<br>Typology   |   |   |   |   |
|--------------------------|------|-------------------------|---|---|---|---|--------------------------|-----------------------------------|-------------------------|---|---|---|---|
| BRIDGE                   | 146  | Sedia<br>Chair          |   |   |   | • | ROUND                    | 435                               | Poltroncina<br>Armchair |   |   |   | • |
|                          | 147  | Poltroncina<br>Armchair |   |   |   | • |                          | 465                               | Sedia<br>Chair          | • |   |   |   |
|                          | 148  | Sgabello<br>Barstool    |   |   |   | • |                          | 466                               | Poltroncina<br>Armchair | • |   |   |   |
| DARWIN                   | 521  | Sedia<br>Chair          | • |   |   |   | SEGNO                    | 263                               | Sedia<br>Chair          |   |   |   | • |
|                          | 522  | Poltroncina<br>Armchair | • |   |   |   |                          | 264                               | Sgabello<br>Barstool    |   |   |   | • |
| GRACE                    | 280  | Sedia<br>Chair          | • |   |   |   | STAR                     | 268                               | Poltroncina<br>Armchair |   |   |   | • |
|                          | 281  | Poltroncina<br>Armchair | • |   |   |   |                          | 161                               | Sedia<br>Chair          |   |   |   | • |
| MIA                      | 410  | Sedia<br>Chair          |   |   | • | • | THOR                     | 162                               | Poltroncina<br>Armchair |   |   |   | • |
|                          | 411  | Poltroncina<br>Armchair |   |   | • | • |                          | 164                               | Sgabello<br>Barstool    |   |   |   | • |
|                          | 412  | Sgabello<br>Barstool    |   |   | • | • |                          | 655                               | Sedia<br>Chair          |   |   | • |   |
| MOM                      | 639  | Sedia<br>Chair          |   | • |   |   | 657                      | Sgabello<br>Barstool              |                         |   | • |   |   |
|                          | 640  | Poltroncina<br>Armchair |   | • |   |   | 658                      | Sgabello basso<br>Dining barstool |                         |   | • |   |   |
| RIO R50                  | 790  | Sedia<br>Chair          |   |   |   | • | URBAN                    | 208                               | Sedia<br>Chair          |   |   |   | • |
|                          | 791  | Poltroncina<br>Armchair |   |   |   | • |                          | 209                               | Poltroncina<br>Armchair |   |   |   | • |
| RIVIERA                  | 434  | Sedia<br>Chair          |   |   |   | • | 211                      | Sgabello<br>Barstool              |                         |   |   | • |   |

# CARATTERISTICHE CUSCINI CUSHIONS CHARACTERISTICS

## CARATTERISTICHE TESSUTO ESTERNO DEL CUSCINO

La gamma dei tessuti, che costituiscono la cover esterna, comprende diverse composizioni e diversi trattamenti superficiali che comportano differenti caratteristiche, descritte nelle rispettive schede tecniche. Verificare i tessuti previsti e le relative schede tecniche nel sito [www.emu.it](http://www.emu.it)

## CARATTERISTICHE FODERA INTERNA IN TESSUTO

Per fodera interna si intende il tessuto che racchiude l'imbottitura e può essere:

- **Fodera idrorepellente.** Si intende che la fodera è realizzata con tessuto trattato per facilitare lo scorrere dell'acqua sulla superficie. I tessuti idrorepellenti resistono alla permeabilità dell'acqua se questa vi cade ad una bassa pressione (ad esempio ad una leggera pioggia).
- **Fodera impermeabile.** Si intende che la fodera è realizzata con tessuto trattato per resistere alla penetrazione dell'acqua. Questo tipo di trattamento è il massimo grado di protezione dall'acqua per i tessuti, ma sopra una determinata pressione comunque l'acqua può penetrare nel cuscino.

Si consiglia quindi di proteggere sempre i cuscini dalla pioggia e, se bagnati, di sfoderarli (cover esterna) e lasciarli asciugare all'aria e al sole.

## CHARACTERISTICS OF THE EXTERNAL CUSHION'S FABRIC

The fabrics range for the external cover includes various compositions and surface treatments involving various characteristics, described in the respective datasheets. Check the required fabrics and associated datasheets at [www.emu.it](http://www.emu.it).

## CHARACTERISTICS OF THE FABRIC INNER LINING

The inner lining is the fabric that encloses the padding and can be:

- **Water-repellent lining.** This means that the inner cushion cover is made of treated fabric to facilitate the flow of water across the surface. Water-repellent fabrics are resistant to water permeability if water falls over them at low pressure (e.g., light rain).
- **Waterproof lining.** This means that the inner cushion cover is made of treated fabric to withstand the flow of water. This type of treatment is the highest degree of water protection for tissues, but above some pressure water may still penetrate the pad.

It is therefore recommended to always protect the cushions from the rain and, if wet, remove the covers (external cover) and leave them out to air and sun dry.

| Collezione<br>Collection | Cod.    | Tipologia<br>Typology                               | Cuscini con tessuti Basic<br>Cushion with Basic fabrics                           |   |  | Cuscini con tessuti Standard e Premium<br>Cushion with Standard and Premium fabrics |   |  |
|--------------------------|---------|---|---|---|--|---|---|--|
|                          |         |   | NON ha fodera<br>interna, solo<br>imbottitura<br>NO inner lining,<br>only padding | Fodera interna<br>idrorepellente<br>Water-repellent<br>inner lining | Fodera interna<br>impermeabile<br>Waterproof<br>inner lining | NON ha fodera<br>interna, solo<br>imbottitura<br>NO inner lining,<br>only padding   | Fodera interna<br>idrorepellente<br>Water-repellent<br>inner lining | Fodera interna<br>impermeabile<br>Waterproof<br>inner lining |
| AERO                     | C/023*  | Cuscino seduta<br>Seat cushion                      | •   |   |  |   |   |  |
|                          | C/026*  | Cuscino seduta<br>Seat cushion                      | •   |   |  |   |   |  |
|                          | C/027*  | Cuscino seduta<br>Seat cushion                      | •   |   |  |   |   |  |
| ALA                      | C/152*  | Cuscino seduta<br>Seat cushion                      | •   |   |  |   |   |  |
| ATHENA                   | C/3400* | Cuscino seduta<br>Seat cushion                      | •   |   |  |   |   |  |
|                          | C/3416* | Cuscino seduta e schienale<br>Seat and back cushion | •   |   |  |   |   |  |
|                          | C/3417* | Cuscino seduta e schienale<br>Seat and back cushion | •   |   |  |   |   |  |
| CANNOLÈ                  | C/1080* | Cuscino seduta<br>Seat cushion                      |   | •   |  |   | •   |  |
|                          | C/1081* | Cuscino schienale<br>Back cushion                   |   | •   |  |   | •   |  |
|                          | C/1082* | Cuscino bracciolo dx<br>Right armrest cushion       |   | •   |  |   | •   |  |
|                          | C/1083* | Cuscino bracciolo sx<br>Left armrest cushion        |   | •   |  |   | •   |  |
|                          | C/1084* | Cuscino schienale angolare<br>Corner back cushion   |   | •   |  |   | •   |  |
|                          | C/1085* | Cuscino seduta angolare<br>Corner seat cushion      |   | •   |  |   | •   |  |
| CAROUSEL                 | C/1086* | Cuscino pouf<br>Pouf cushion                        |   | •   |  |   | •   |  |
|                          | C/1211* | Cuscino seduta<br>Seat cushion                      | •   |   |  |   | •   |  |
|                          | C/1215* | Cuscino seduta<br>Seat cushion                      | •   |   |  |   | •   |  |
|                          | C/1219* | Cuscino seduta<br>Seat cushion                      | •   |   |  |   | •   |  |
|                          | C/1222* | Cuscino seduta<br>Seat cushion                      | •   |   |  |   | •   |  |
| COMO                     | C/1200* | Cuscino seduta<br>Seat cushion                      | •   |   |  |   | •   |  |
|                          | C/1201* | Cuscino schienale<br>Back cushion                   | •   |   |  |   | •   |  |
|                          | C/1204* | Cuscino seduta<br>Seat cushion                      | •   |   |  |   | •   |  |
|                          | C/1205* | Cuscino seduta<br>Seat cushion                      | •   |   |  |   | •   |  |
|                          | C/1206* | Cuscino schienale<br>Back cushion                   |   | •   |  |   | •   |  |
| CROSS                    | C/421*  | Cuscino seduta<br>Seat cushion                      | •   |   |  |   | •   |  |
|                          | C/422*  | Cuscino seduta<br>Seat cushion                      | •   |   |  |   | •   |  |
| DARWIN                   | C/521*  | Cuscino seduta<br>Seat cushion                      | •   |   |  |   | •   |  |
|                          | C/524*  | Cuscino seduta<br>Seat cushion                      | •   |   |  |   | •   |  |
|                          | C/527*  | Cuscino seduta<br>Seat cushion                      | •   |   |  |   | •   |  |

\* Cuscini sfoderabili (fodera esterna in tessuto).—Removable external cover.

| Collezione<br>Collection | Cod.  | Tipologia<br>Typology                                 | Cuscini con tessuti Basic<br>Cushion with Basic fabrics                           |   |  | Cuscini con tessuti Standard e Premium<br>Cushion with Standard and Premium fabrics |   |  |
|--------------------------|---|---|---|---|--|---|---|--|
|                          |   |   | NON ha fodera<br>interna, solo<br>imbottitura<br>NO inner lining,<br>only padding | Fodera interna<br>idrorepellente<br>Water-repellent<br>inner lining | Fodera interna<br>impermeabile<br>Waterproof<br>inner lining | NON ha fodera<br>interna, solo<br>imbottitura<br>NO inner lining,<br>only padding   | Fodera interna<br>idrorepellente<br>Water-repellent<br>inner lining | Fodera interna<br>impermeabile<br>Waterproof<br>inner lining |
| DOCK                     | C/745*                                      | Cuscino seduta<br>Seat cushion                        |   |   |  |   | •   |  |
|                          | C/751*                                      | Cuscino angolo dx basso<br>Short right corner cushion |   |   |  |   | •   |  |
|                          | C/752*                                      | Cuscino angolo sx basso<br>Short left corner cushion  |   |   |  |   | •   |  |
|                          | C/753*                                      | Cuscino angolo dx alto<br>Tall right corner cushion   |   |   |  |   | •   |  |
|                          | C/754*                                      | Cuscino angolo sx alto<br>Tall left corner cushion    |   |   |  |   | •   |  |
|                          | C/756*                                      | Cuscino seduta angolare<br>Corner seat cushion        |   |   |  |   | •   |  |
|                          | C/757*                                      | Cuscino seduta<br>Seat cushion                        |   |   |  |   | •   |  |
|                          | C/758*                                      | Cuscino seduta isola<br>Island seat cushion           |   |   |  |   | •   |  |
|                          | C/759*                                      | Cuscino schienale basso<br>Short back cushion         |   |   |  |   | •   |  |
| C/760*                   | Cuscino schienale alto<br>Tall back cushion |   |   |   |  | •   |   |  |
| HEAVEN                   | C/485*                                      | Cuscino seduta e schienale<br>Seat and back cushion   |   |   |  |   | •   |  |
|                          | C/486*                                      | Cuscino seduta e schienale<br>Seat and back cushion   |   |   |  |   | •   |  |
|                          | 495/S*                                      | Cuscino seduta imbottito<br>Padded seat cushion       |   |   |  |   | •   |  |
| IVY                      | C/585*                                      | Cuscino seduta e schienale<br>Seat and back cushion   |   |   |  |   | •   |  |
|                          | C/586*                                      | Cuscino seduta e schienale<br>Seat and back cushion   |   |   |  |   | •   |  |
| LYZE                     | C/615                                       | Cuscino seduta<br>Seat cushion                        |   |   |  |   | •   |  |
|                          | C/616                                       | Cuscino seduta e schienale<br>Seat and back cushion   |   |   |  |   | •   |  |
|                          | C/617                                       | Cuscino seduta e schienale<br>Seat and back cushion   |   |   |  |   | •   |  |
| MOM                      | C/640*                                      | Cuscino seduta<br>Seat cushion                        | •   |   |  |   |   |  |
|                          | C/641*                                      | Cuscino schienale<br>Back cushion                     | •   |   |  |   |   |  |
| NEF                      | C/626*                                      | Cuscino seduta<br>Seat cushion                        |   |   |  |   | •   |  |
|                          | C/627*                                      | Cuscino seduta e schienale<br>Seat and back cushion   |   |   |  |   | •   |  |
|                          | S/626                                       | Cuscino schienale<br>Back cushion                     |   |   |  |   | •   |  |
| RE-TROUVÉ                | C/566*                                      | Cuscino seduta e schienale<br>Seat and back cushion   |   |   |  |   | •   |  |
|                          | C/575*                                      | Cuscino seduta<br>Seat cushion                        |   |   |  |   | •   |  |
| RIVIERA                  | C/434*                                      | Cuscino seduta<br>Seat cushion                        |   |   |  |   | •   |  |
|                          | C/437*                                      | Cuscino seduta<br>Seat cushion                        |   |   |  |   | •   |  |
| RONDA                    | C/116*                                      | Cuscino seduta e schienale<br>Seat and back cushion   | •   |   |  |   |   |  |
|                          | C/116S*                                     | Cuscino seduta<br>Seat cushion                        | •   |   |  |   |   |  |
| ROUND                    | C/468*                                      | Cuscino intero<br>Whole cushion                       |   |   |  |   | •   |  |
|                          | C/469*                                      | Cuscino seduta e schienale<br>Seat and back cushion   |   |   |  |   | •   |  |
| SHINE                    | C/247*                                      | Cuscino seduta<br>Seat cushion                        |   |   |  |   | •   |  |
|                          | C/249*                                      | Cuscino seduta<br>Seat cushion                        |   |   |  |   | •   |  |
| STAR                     | C/161*                                      | Cuscino seduta<br>Seat cushion                        | •   |   |  |   |   |  |
|                          | C/162*                                      | Cuscino schienale<br>Back cushion                     | •   |   |  |   |   |  |
| TAMI                     | C/770*                                      | Cuscino seduta<br>Seat cushion                        |   | •   |  |   | •   |  |
|                          | C/771*                                      | Cuscino schienale<br>Back cushion                     |   | •   |  |   | •   |  |
|                          | C/772*                                      | Cuscino bracciolo<br>Armrest cushion                  |   | •   |  |   | •   |  |
|                          | C/773*                                      | Cuscino decorativo<br>Decorative cushion              |   | •   |  |   | •   |  |
| TERRAMARE                | C/729*                                      | Cuscino seduta e schienale<br>Seat and back cushion   |   |   | •  |   |   | •  |

\* Cuscini sfoderabili (fodera esterna in tessuto).—Removable external cover.

## CURA, MANUTENZIONE E AVVERTENZE CUSCINI EMU CARE, MAINTENANCE AND WARNINGS EMU CUSHIONS

All'interno dell'imballo dei cuscini, uno per ogni imballo, e downloadabile dal sito, c'è una scheda "Cuscini EMU: cura, manutenzione e avvertenze". Questo documento è la fonte ufficiale EMU che contiene le indicazioni di corretta manutenzione.

- Il contatto prolungato con sostanze grasse e/o coloranti può provocare macchie permanenti e deteriorare la struttura del filato. È necessario rimuovere immediatamente tali sostanze prima che arrivino in contatto con la fodera interna.
- In caso di utilizzo vicino al mare o piscine si consiglia un lavaggio periodico.
- Estrarre con delicatezza l'imbottitura utilizzando l'apposita cerniera prima di procedere al lavaggio. Porre particolare attenzione quando si estrae l'imbottitura dal cuscino, per agevolare l'operazione di rimozione piegare l'imbottitura su se stessa. Al termine del lavaggio della fodera, usando lo stesso sistema, reinserire l'imbottitura con cura.
- Prima di avviare il lavaggio, chiudere le zip e chiudere tutti i sistemi di fissaggio in Velcro® facendo aderire le due componenti del Velcro® come se si stesse chiudendo o fissando il cuscino, così da prevenire ogni rischio di danneggiamento del tessuto. Per i cuscini seduta Tami C/770, si consiglia di conservare la protezione in Velcro® apposta sul lembo di fissaggio al momento in cui si riceve il cuscino nuovo imballato e di applicare tale protezione sul lembo stesso quando si effettua il lavaggio della fodera esterna.
- Evitare di lavare fodere di colori differenti nella stessa sessione di lavaggio.
- Lavaggio: seguire le istruzioni specifiche per ogni materiale riportate sull'apposita etichetta. Utilizzare acqua e detersivi liquidi non abrasivi con PH neutro e incolore. Eventualmente lasciare agire il detersivo alcuni minuti. Non usare ammorbidente. Sciacquare abbondantemente con acqua a temperatura non superiore a 30°C. Nel caso di utilizzo di dispositivi a pressione, tenere la punta del diffusore ad una distanza di almeno 60/70 cm dalla superficie del manufatto. Se necessario ripetere l'operazione. Non utilizzare spugne abrasive per smacchiare e non trattare con candeggina e cloro. Asciugare in modo naturale. Non reinserire l'imbottitura prima della completa asciugatura della fodera.
- Se il cuscino è esposto a pioggia o viene accidentalmente bagnato, si consiglia di metterlo in posizione e zona arieggiate per facilitarne l'asciugatura. In caso in cui la condizione sia più severa, ripetere la stessa operazione ma estraendone l'imbottitura interna, per accelerare il processo di asciugatura.
- Nel caso di periodi di prolungato inutilizzo e/o di rimessaggio invernale dei cuscini, sconsigliamo di utilizzare cover impermeabili per coprire i cuscini e di assicurarsi che gli stessi siano riposti in luoghi arieggiati ed asciutti e rialzati da terra onde prevenire muffe causate dalla condensa di umidità.
- Prima di riporre il prodotto per la stagione di inutilizzo assicurarsi che questo sia completamente asciutto e pulito.
- Tutti i tessuti possono subir un naturale viraggio di colore a seguito di un'esposizione prolungata al sole; tale effetto è da considerarsi normale e varia da tessuto a tessuto.

Inside the packaging of the cushions, one for each package, and downloadable from the website, there is a specific data sheet "EMU cushions: care, upkeep and warnings". This document is the official EMU document for the correct maintenance.

- Prolonged contact with greasy substances and/or dyes can cause permanent stains and deterioration of the yarn structure. It is necessary to remove such substances immediately before they come into contact with the inner lining.
- Cushions used near the seaside or near a swimming pool require more frequent cleaning.
- Carefully remove the padding using the zip before washing. Pay particular attention to removing the cover from the cushion, and fold the cover back on itself to facilitate the process of removal. After having cleaned the cover, reinsert it using the same method.
- Before starting washing, close the zips and close all Velcro® fasteners by adhering the two Velcro® components as if you were closing or fastening the cushion in order to prevent any risk of damage to the fabric. For Tami C/770 seat cushions, it is recommended to keep the Velcro® protection on the fastening flap when you receive the cushion in its new packaging and to apply the Velcro® to the cushion.
- Avoid washing linings of different colors in the same washing session.
- Washing: follow the material-specific instructions on the washing label. Use water and non-abrasive liquid detergents with a neutral and colorless PH. If required, let the detergent act for a few minutes. Do not use fabric softener. Rinse thoroughly with water at a temperature not exceeding 30°C. When using pressure devices, keep the tip of the diffuser at a distance of at least 60/70 cm from the surface of the item. If necessary, repeat the operation. Do not use abrasive sponges to remove stains and do not treat with bleach or chlorine. Dry naturally. Do not reinsert the upholstery until the cover is completely dry.
- If the cushion is exposed to rain or is accidentally wet, it is recommended to place it in an airy area to facilitate drying. If the condition is more severe, repeat the same operation but removing the inner padding to speed up the drying process.
- In case of prolonged periods of inactivity and/or winter storage of the cushions, we do not recommend using waterproof covers to cover the cushions.
- We recommend to ensure that they are placed in an airy and dry place and also raised off the ground to prevent mould caused by condensation of moisture.
- Make sure the product is completely dry and clean before storing it for the rest of the season.
- All textiles may undergo a natural color change following prolonged exposure to the sun, which is normal and varies from fabric to fabric.

# TEXTILE COLLECTION

La collezione tessile EMU è composta da una vasta gamma di tessuti suddivisi in basic, standard e premium. Un progetto trasversale che parte da trame prodotte esclusivamente per EMU, da cui sono nati 10 mood estremamente ricchi di abbinamenti. Trame preziose e cromatismi fatti di toni polverosi, pattern leggeri e fantasie delicate facilmente interscambiabili, ispirati al tema del viaggio tra alcune delle più affascinanti isole dei mari italiani. Ne nascono atmosfere sofisticate che accompagnano gli arredi EMU in un percorso mentale di 10 tappe che hanno suggerito le nuove palette.

The EMU textile collection consisting of a wide range of fabrics divided into basic, standard and premium. A transversal project that starts from wefts exclusively produced for EMU, from which 10 moods, extremely rich in combinations, were born. Lavish textures and chromatisms made of powdery tones, light patterns and delicate design, easily interchangeable and inspired by the theme of travel among some of the most fascinating islands of the Italian seas. The result is sophisticated atmospheres that lead the EMU furnishings in a mental journey of 10 stages that inspired the new palettes.

CAPRERA

FILICUDI

LINOSA

ISCHIA

PANTELLERIA

SALINA

VULCANO

SPARGI

PANAREA

ELBA

## CAPRERA



## FILICUDI





# LINOSA



# PANTELLERIA



# ISCHIA

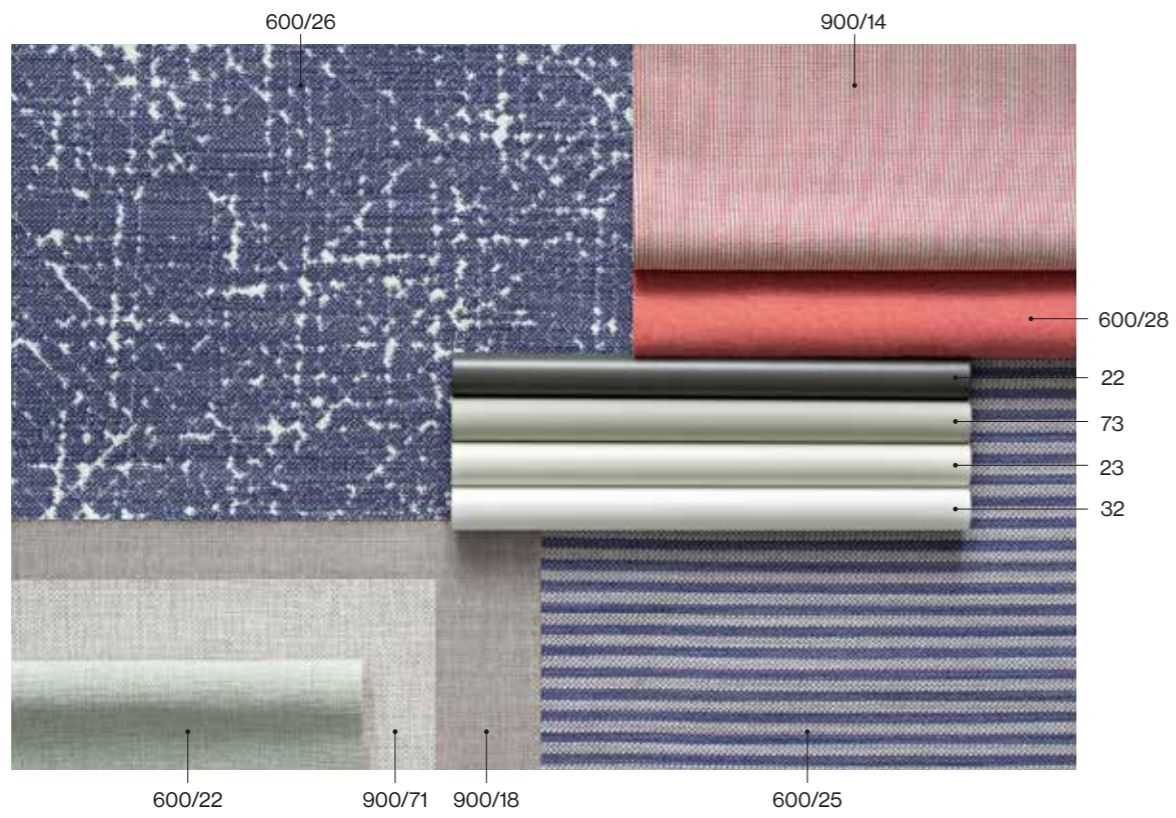

# SALINA

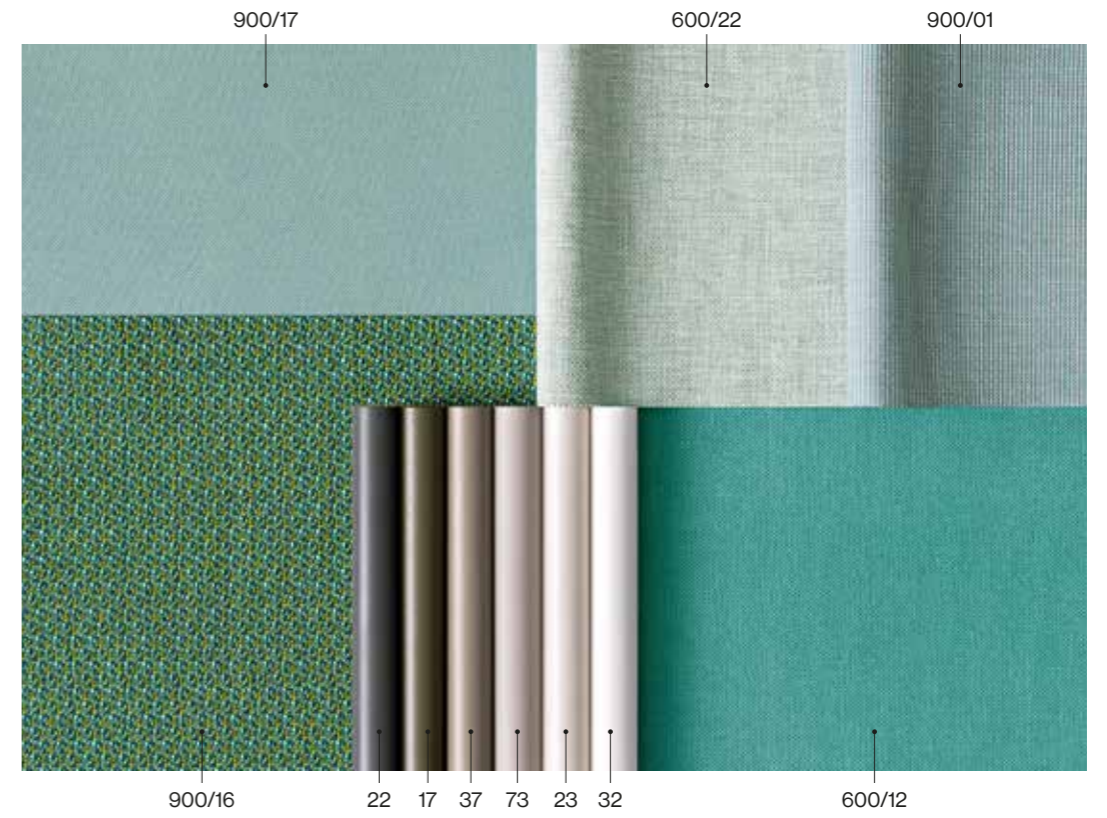

# VULCANO



# PANAREA



# SPARGI



# ELBA



# MATERIALI

## MATERIALS



### METALLI—METALS

METALLI-MAGLIE METALLICHE  
METALS-STEEL MESHES

MICROFIBRA  
MICROFIBER

EMU MAGLIA SINTETICA  
EMU SYNTHETIC MESH

EMU-TEX

ABS

CINGHIE ELASTICHE—ELASTIC BELTS

CORDE SINTETICHE  
SYNTHETIC ROPES

CRISTALLO TEMPERATO  
TEMPERED GLASS

CUSCINI-TEX—TEX-CUSHIONS

ECO-CUOIO—ECO-LEATHER

GRES PORCELLANATO  
PORCELAIN STONEWARE

HPL

LEGNI—WOODS

MATTONELLE—TILES

WPC

TESSUTI BASIC—BASIC FABRICS

TESSUTI OMBRELLONI  
SUNSHADE FABRICS

TESSUTI PREMIUM—PREMIUM FABRICS

TESSUTI STAMPATI—PRINTED FABRICS

TESSUTI CUSCINI CONTRACT  
CONTRACT CUSHIONS FABRICS

TESSUTI STANDARD  
STANDARD FABRICS

TESSUTI TAPPETI—RUGS FABRICS

## METALLI—METALS

ACCIAIO - Lega di ferro e carbonio con percentuale di carbonio inferiore al 2% trattata per resistere agli agenti atmosferici con l'esclusivo processo anticorrosione EMU-Coat.

ALLUMINIO - Leghe di alluminio, particolarmente idonee per la lavorazione a freddo e per la pressofusione, trattate opportunamente per resistere agli agenti atmosferici e verniciate a polvere.

STEEL - Iron and carbon alloy, with carbon content below 2%, treated to withstand the elements with the unique EMU-Coat anticorrosion process.

ALUMINIUM - Aluminium alloys, particularly suitable for cold-working and for die-casting, appropriately treated to withstand the elements and powder coated.



## METALLI-MAGLIE METALLICHE—METALS-STEEL MESHES



## MICROFIBRA—MICROFIBER

Multifilamento 100% PES particolarmente resistente all'uso quotidiano, in aspetto nubuk, per una componentistica di alta qualità e durata, caratterizzata dalla tessitura di fibre di poliestere aventi titolo uguale o minore di 1 dtex.

100% PES multifilament particularly resistant to daily use, in nubuck aspect, for high quality and long-lasting components, characterized by the weaving of polyester fibers having a titre equal to or less than 1 dtex.

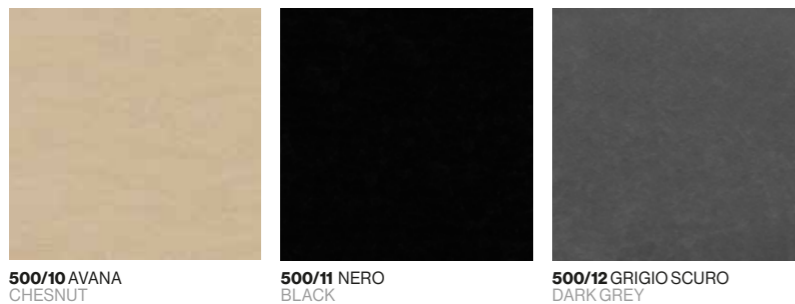

## EMU MAGLIA SINTETICA—EMU SYNTHETIC MESH

Materiale composto costituito da PVC (45%), PP (40%) e PES (5%), e costruito tramite una maglia doppia in "Jacquard" a due fili, GG05, con caratteristiche adatte per uso esterno ed interno. L'unione dei due filati crea una "maglia sintetica" morbida al tatto, con alte qualità tecniche contro i microrganismi.

Composite material consisting of PVC (45%), PP (40%) and PES (5%), and constructed using a "Jacquard" double yarn in GG05 two-yarn, fit for out- and indoor use. The two united yarns create a "synthetic mesh" which is soft to the touch, with high technical qualities against microorganisms.

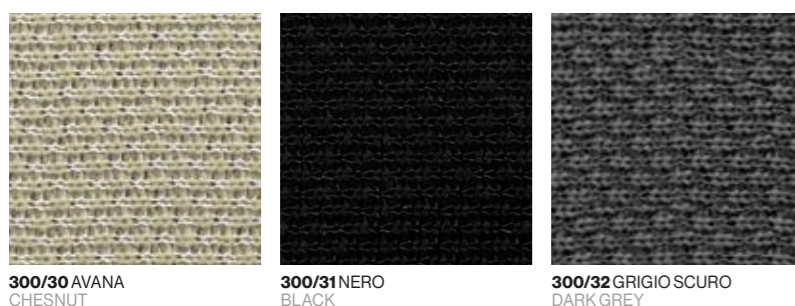

## EMU-TEX—EMU-TEX

È un tessuto tecnico per esterni realizzato con filo in polivinilcloruro. Ha caratteristiche di eccezionale robustezza a garanzia di una durata nel tempo: massima resistenza ai raggi ultravioletti, agli agenti atmosferici, all'umidità e agli sbalzi di temperatura.

It is a technical fabric for outdoor use made with polyvinyl chloride thread. It features exceptional strength to ensure durability: maximum resistance to UV rays, the elements, humidity and sudden changes in temperature.





**300/83** RUGGINE  
RUST

**300/86** NOCCIOLA  
HAZEL

**300/95** NERO  
BLACK

## ABS

L'ABS è un tecnopolimero termoplastico che, una volta stabilizzato, resiste bene alle radiazioni UV e quindi è impiegabile all'esterno. Presenta buone caratteristiche meccaniche anche a basse temperature e possiede un'elevata durezza, resistenza all'urto e alla scalfitura. Tali caratteristiche lo rendono ideale per impieghi in vari settori, fra cui quello dell'arredamento.

ABS is a thermoplastic techno-polymer that, once stabilised, resists well even against UV radiation and can therefore be used outside. It has strong mechanical features even at low temperatures and has high strength, impact and scratch resistance. These features make it ideal for use in a range of sectors, including furnishing.

## CIAK



**23** BIANCO  
WHITE

**24** NERO  
BLACK

**37** GRIGIO/VERDE  
GREY/GREEN

**41** MARRONE  
BROWN

## LUCIOLE

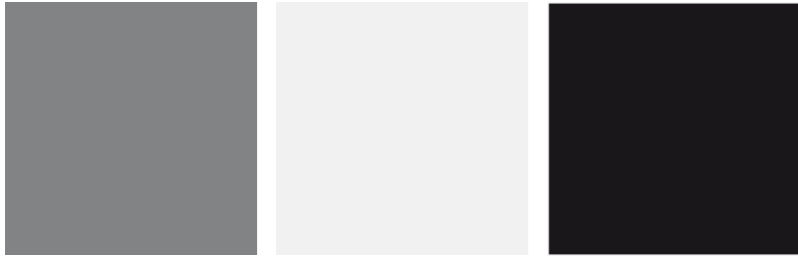

**20** GRIGIO  
GREY

**23** BIANCO  
WHITE

**24** NERO  
BLACK

## CINGHIE ELASTICHE — ELASTIC BELTS

Ottenuta mediante la tessitura di materiali sintetici quali fibre di propilene (71%) e fili di gomma sintetica (29%), permette di essere usata all'esterno.

Obtained by weaving synthetic materials such as propylene fibres (71%) and synthetic rubber thread (29%), enabling it to be used outside.

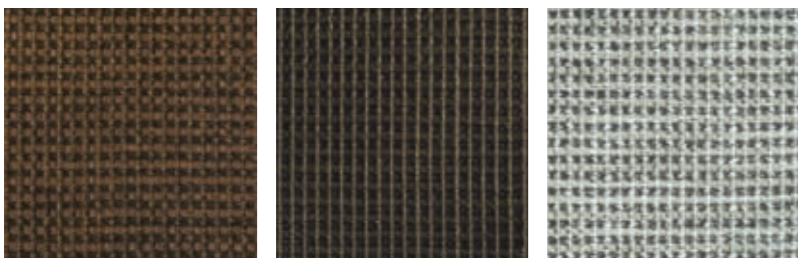

**57** MARRONE  
BROWN

**62** GRIGIO/NERO  
GREY/BLACK

**64** GRIGIO/VERDE  
GREY/GREEN

## CORDE SINTETICHE — SYNTHETIC ROPES

Doppia treccia costruita con anima in poliestere e copertura in propilene multifilamento. La fibra esterna di cui è composta è impermeabile e resistente ai raggi UV.

Double braid with polyester core and multifilament propylene covering. The external fibre is waterproof and resistant to UV rays.

### CAROUSEL

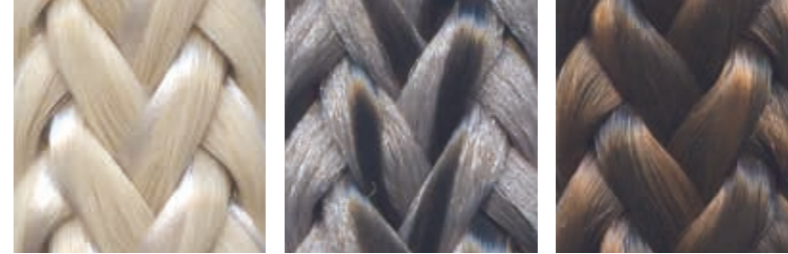

**12** AVORIO MELANGIATO  
MELANGE IVORY

**18** GRIGIO MELANGIATO  
MELANGE GREY

**19** MARRONE MELANGIATO  
MELANGE BROWN

### CROSS

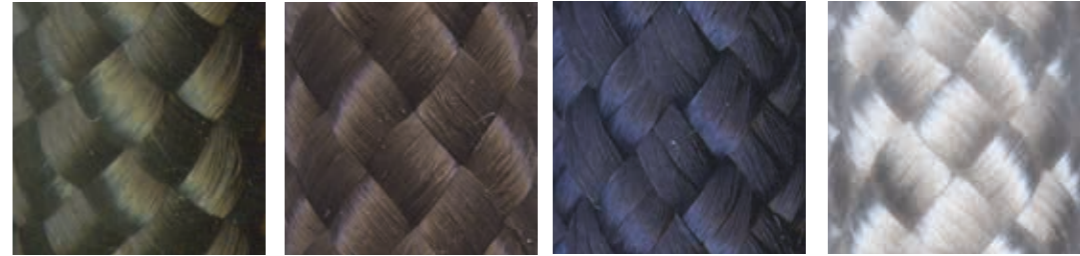

**29** VERDE  
GREEN

**42** MARRONE  
BROWN

**47** BLU  
BLUE

**56** CEMENTO  
CEMENT

### NEF

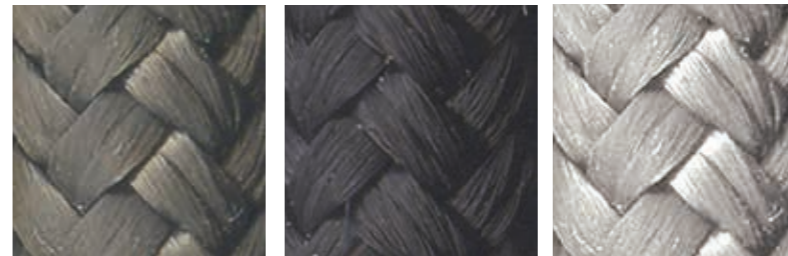

**30** GRIGIO SCURO  
DARK GREY

**31** NERO  
BLACK

**32** GRIGIO CHIARO  
LIGHT GREY

### VETTA



**31** NERO  
BLACK

**32** GRIGIO CHIARO  
LIGHT GREY

**33** TABACCO  
TOBACCO

## CRISTALLO TEMPERATO—TEMPERED GLASS

Cristallo temperato in conformità con le normative internazionali BS 6206 e prodotto nel rispetto della normativa BS 7376.

Tempered glass in compliance with international standards BS 6206 and produced in compliance with standard BS 7376.

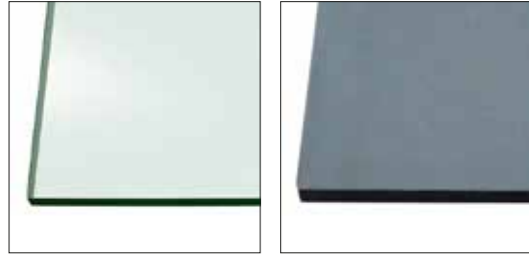

**00** TRASPARENTE  
TRANSPARENT

**83** GRIGIO FUMÈ  
SMOKY GREY

## CUSCINI-TEX—TEX-CUSHIONS

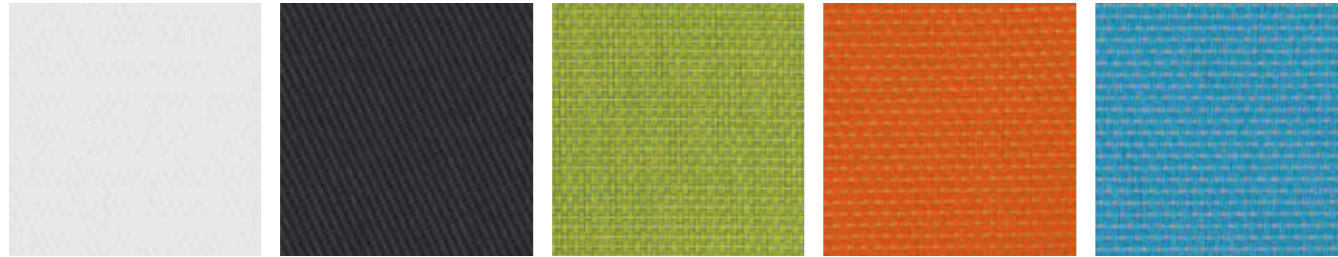

**300/10** BIANCO  
WHITE

**300/11** ANTRACITE  
CHARCOAL

**300/12** VERDE  
GREEN

**300/13** ARANCIO  
ORANGE

**300/14** ACQUAMARINA  
AQUAMARINE



**300/15** LILLA  
LILAC

## ECO-CUOIO—ECO-LEATHER

L'eco-cuoio è realizzato con microfibra di Nylon compattata in bagno di poliuretano. Successivamente viene spalmata con poliuretano in tinta.

The eco-leather is made of compacted Nylon micro-fibre in polyurethane bath. It is then coated with polyurethane of the same color.



**200/92** BIANCO  
WHITE

**200/93** MARRONE  
BROWN

**200/94** GRIGIO / VERDE  
GREY / GREEN

**200/95** NERO  
BLACK

## GRES PORCELLANATO—PORCELAIN STONEWARE

Il gres porcellanato, grazie alle sue eccellenti proprietà fisiche e meccaniche, è ideale per uso esterno, essendo inattaccabile dagli agenti atmosferici e inalterabile ai raggi UV. Le sue qualità gli permettono di essere idrorepellente ed oleorepellente. Il gres porcellanato è ottenuto tramite il processo di sintetizzazione di argille ceramiche, feldspati, caolini e sabbia. Queste materie prime vengono macinate ed atomizzate fino ad ottenere una granulometria omogenea adatta alla pressatura. La cottura avviene a 1150-1250 °C per circa 25-30 minuti allo scopo di determinare la ceramizzazione dell'impasto attribuendone così le tipiche caratteristiche di resistenza alle abrasioni.

Thanks to its excellent physical and mechanical properties, porcelain stoneware is ideal for outdoor use, since it is resistant to atmospheric corrosion and unaffected by UV exposure. Its qualities allow it to be water and oil repellent. Porcelain stoneware is obtained via the synthesizing process of ceramic clay, feldspar, kaolin and sand. These raw materials undergo grinding and atomization until a homogeneous particle size, suitable for pressing, is obtained. Firing takes place at 1150-1250 °C for approx. 25-30 minutes in order to determine the ceramization of the mixture, ensuring the typical resistance to abrasion.



**34** BASALTINA

**35** BIANCO STATUARIO  
STATUARIO WHITE

**36** EMPERADOR

**37** GREIGE

**38** GRIGIO SCURO  
DARK GREY

## HPL

Materiale autoportante adatto all'esposizione all'ambiente esterno. È costituito da strati di carta Kraft impregnati con resine fenoliche e da uno strato superficiale decorativo impregnato con resine termoindurenti. Questi strati sono pressati a 9 Mp e ad una temperatura di 150 gradi centigradi.

Self-supporting material suitable for outdoor exposure. It consists of layers of kraft paper impregnated with phenolic resins and of a decorative surface layer impregnated with thermosetting resins. These layers are pressed at 9 Mp and at a temperature of 150 degrees centigrade.

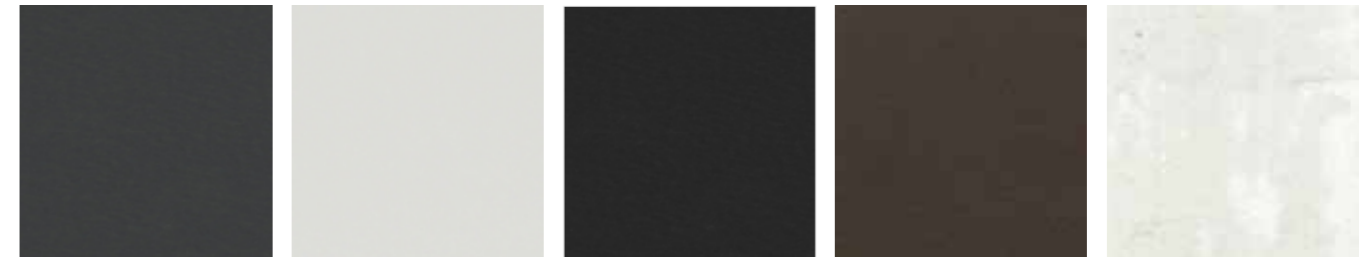

**22** GRIGIO  
GREY

**23** BIANCO  
WHITE

**24** NERO  
BLACK

**41** MARRONE  
BROWN

**49** LEGNO SBIANCATO  
BLEACHED WOOD



**54** MARRONE VINTAGE  
VINTAGE BROWN



**71** TORTORA  
TAUPE

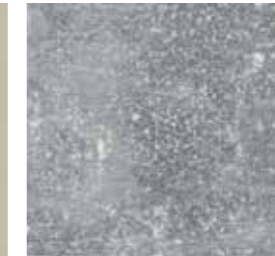

**73** CEMENTO  
CEMENT



**86** TAMBORA

## LEGNI—WOODS

**BAMBÙ** - Il bambù è un materiale dalla rapida crescita che viene raccolto senza causare deforestazione. Dopo la raccolta lo strato più esterno viene rimosso e le lamelle di bambù vengono modificate con uno speciale processo di termotrattamento a 200°, che aumenta la stabilità del materiale, assicura la protezione del materiale contro i funghi e garantisce la più alta classe di durabilità possibile. Dopo il processo di compressione al calore le fibre di bambù sono più forti e più dure di qualsiasi specie di legno esistente. Con questo particolare processo si ottiene una tavola massiccia ad alta densità resistente agli agenti atmosferici.

**TEAK** - Tradizionale legno impiegato nell'arredo da esterni dal fascino esotico intramontabile, il teak è un legno duro ad alto contenuto di olio adatto all'uso esterno senza necessità di trattamento di verniciatura. Se non riceve alcun trattamento protettivo, la superficie prenderà una patina grigio argento, naturale protezione della parte interna del legno, considerata un elemento essenziale del fascino del teak. Il teak utilizzato per i prodotti EMU è certificato FSC®.

**USO E MANUTENZIONE** - Trattandosi di un materiale naturale, si potrebbero osservare variazioni di colore tra un prodotto e l'altro o tra i componenti di uno stesso prodotto. In caso in bruschi cambiamenti di temperatura e di umidità, inoltre, potrebbero verificarsi anche delle crepe. Se non riceve alcun trattamento di manutenzione tramite l'applicazione periodica di comuni e specifici protettivi a base olio, la superficie prenderà una patina grigio argento che può essere eliminata anche con una leggera carteggiatura superficiale e successiva lucidatura con panno di iuta. Piccole macchie superficiali dovute a olio o altri prodotti alimentari devono essere rimosse tempestivamente, prima che il legno possa assorbirle in profondità, carteggiando la superficie interessata e lucidando con un panno di iuta. Macchie da caffè, spremute, bevande naturali, senza aggiunte di conservanti, possono essere rimosse tempestivamente con acqua e un panno morbido. Quando il legno si bagna per la prima volta è normale che la superficie diventi un poco ruvida quando si asciuga e la levigatura iniziale può essere ripristinata con una leggera carteggiatura superficiale e successiva lucidatura con panno di iuta. Il teak è un materiale naturale che assorbe l'acqua ed è ricco di olii. Con il passare del tempo, questi olii, per un processo naturale, risalgono in superficie e possono macchiare eventuali cuscini che sono stati utilizzati. Le macchie sui cuscini possono essere rimosse utilizzando acqua e sapone.

**BAMBOO** - Bamboo is a rapidly growing material which is collected without causing deforestation. After harvesting, the outermost layer is removed and the bamboo strips are modified using a special thermo-treatment process at 200°, which increases the stability of the material, ensures protection of the materials against fungi and guarantees the highest durability class possible. After the heat compression process the bamboo fibres become stronger and harder than any existing type of wood. With this specific process you can have a high density hardwood table which is resistant to all weather conditions.

**TEAK** - Traditional wood used for outdoor furniture with an exotic and timeless appeal. Teak is a hard wood with a high oil content suitable for outdoor use, without the need for painting. If it does not receive any protective treatment, the surface will weather into a silvery-grey finish, the natural protection of the internal part of the wood, considered an essential part of teak's charm. The teak used for EMU products is FSC® certified.

**USE AND MAINTENANCE** - As it is a natural material, changes in color from one product to another or between components of the same product may be observed. In case of sudden changes in temperature and humidity, moreover, cracks may also occur. If it does not receive any maintenance treatment with the periodic application of common and specific oil-based protective products, the surface will weather into a silvery-grey finish that can be removed with light surface sanding and subsequent polishing with a hessian cloth. Small surface stains caused by oil or other foodstuffs must be removed immediately, before the wood absorbs them, by sanding the area concerned and polishing it with a hessian cloth. Stains from coffee, juices, natural drinks, without food additives, can be removed promptly with water and a soft cloth. When the wood is wet for the first time, it is normal for the surface to become slightly rough when it dries; the initial polished-effect can be restored with light surface sanding and subsequent polishing with a hessian cloth. Teak is a natural material that absorbs water and is rich in oils. Over time, these oils, by a natural process, rise to the surface and can stain any cushions that have been used. Stains on the pillows can be removed using soap and water.

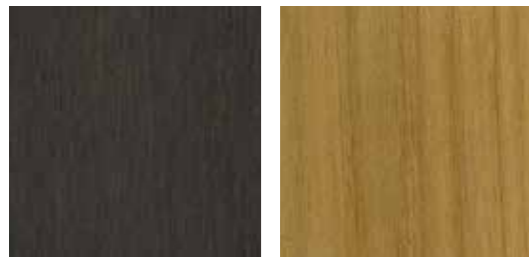

44 BAMBÙ  
BAMBOO

82 TEAK

## MATTONELLE—TILES



01 MATTONELLE CON SCARABEO  
TILES WITH SCRABBLE

65 MATTONELLE CON PESCE  
TILES WITH SCRABBLE

## WPC

Il WPC è un materiale composito costituito da fibre di legno e HDPE. I semilavorati sono ottenuti tramite estrusione del composito. È un materiale resistente ai raggi UV, agli agenti atmosferici e all'umidità. Il WPC non si scheggia e non viene danneggiato da batteri o insetti. Si tratta di un materiale dalla facile manutenzione. Non deve essere protetto da verniciature.

WPC is a composite material made from wood fibers and HDPE. Semi-finished products are obtained by extruding the composite. This material is resistant to UV rays, atmospheric agents and humidity. WPC does not chip and is not damaged by bacteria or insects. It is a material that requires little maintenance. It does not need to be painted for protection.

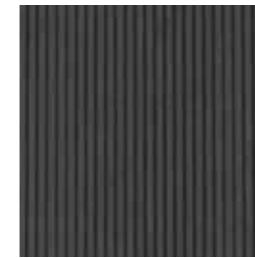

34 ANTRACITE  
CHARCOAL

## TESSUTI BASIC—BASIC FABRICS

**Tessuto acrilico:** si intende una fibra il cui elemento di base è una catena di polimeri composta all'85% da acrilonitrile. La fibra acrilica unisce alle qualità estetiche di un tessuto lussuoso, dalla corposità e dal touch assimilabili a quelli della lana, le qualità funzionali di resistenza agli agenti atmosferici: resiste ai raggi UV, non si macchia e non imputrisce all'acqua grazie alla velocità di asciugatura.

**Acrylic fabric:** a fibre whose base element is a polymer chain consisting of 85% acrylonitrile. Acrylic fibre combines the aesthetic qualities of a luxurious fabric with the texture and feel of wool with the functional qualities of resistance to the elements: UV resistant, it does not stain and does not rot upon contact with water as it is fast-drying.

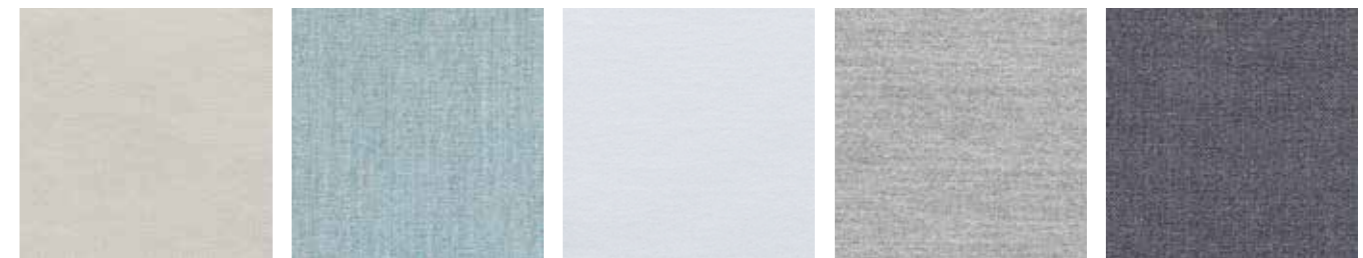

700/4 ECRU

700/10 AZZURRO  
LIGHT BLUE

700/12 BIANCO  
WHITE

700/13 GRIGIO CHIARO  
LIGHT GREY

700/14 GRIGIO SCURO  
DARK GREY

## TESSUTI OMBRELLONI—SUNSHADE FABRICS

**Tessuto in poliestere**  
È una fibra formata da macromolecole lineari costituite prevalentemente da polietilene tereftalato. Ha elevate caratteristiche meccaniche: resiste alla rottura, alla luce, all'abrasione, non si deforma in modo permanente, ha un ottimo recupero elastico ed è idrorepellente.

**Polyester fabric**  
A fibre composed of linear macromolecules consisting mainly of polyethylene terephthalate. It has excellent mechanical properties: it withstands breakage, light and abrasion. It does not deform permanently, it has an excellent elastic recovery and is waterproof.

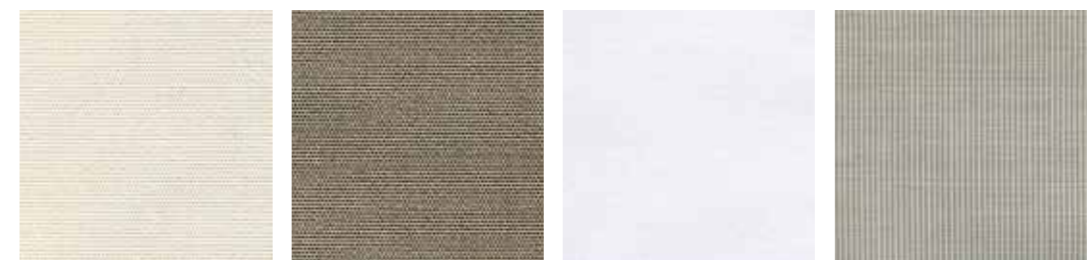

01 BIANCO  
WHITE

80 TORTORA  
TAUPE

81 BIANCO PRO  
WHITE PRO

84 BEIGE PRO

## TESSUTI PREMIUM—PREMIUM FABRICS

Per informazioni circa la composizione dei tessuti compresi in tale fascia e la specifica manutenzione si prega di far riferimento al sito web [www.emu.it](http://www.emu.it) o di rivolgersi a [info@emu.it](mailto:info@emu.it) oppure all'ufficio commerciale di competenza.

For information regarding the composition of fabrics in this range and their specific maintenance, please refer to the website [www.emu.it](http://www.emu.it), write to [info@emu.it](mailto:info@emu.it) or contact the respective sales office.

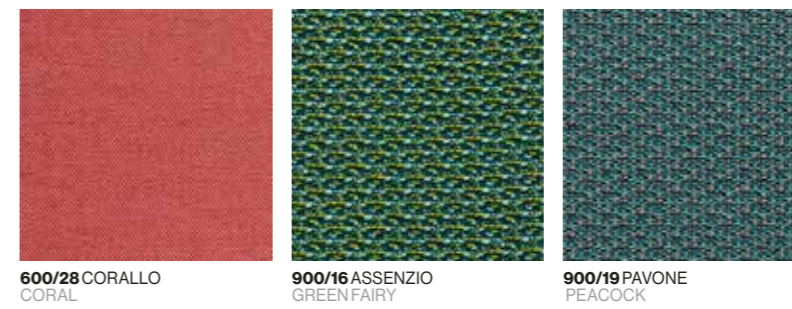

## TESSUTI STAMPATI—PRINTED FABRICS



## TESSUTI CUSCINI CONTRACT\* CONTRACT CUSHIONS FABRICS\*

Per informazioni circa la composizione dei tessuti compresi in tale fascia e la specifica manutenzione si prega di far riferimento al sito web [www.emu.it](http://www.emu.it) o di rivolgersi a [info@emu.it](mailto:info@emu.it) oppure all'ufficio commerciale di competenza.

For information regarding the composition of fabrics in this range and their specific maintenance, please refer to the website [www.emu.it](http://www.emu.it), write to [info@emu.it](mailto:info@emu.it) or contact the respective sales office.

\*Tessuti IDROREPELLENTI

\*WATER-REPELLENT fabrics

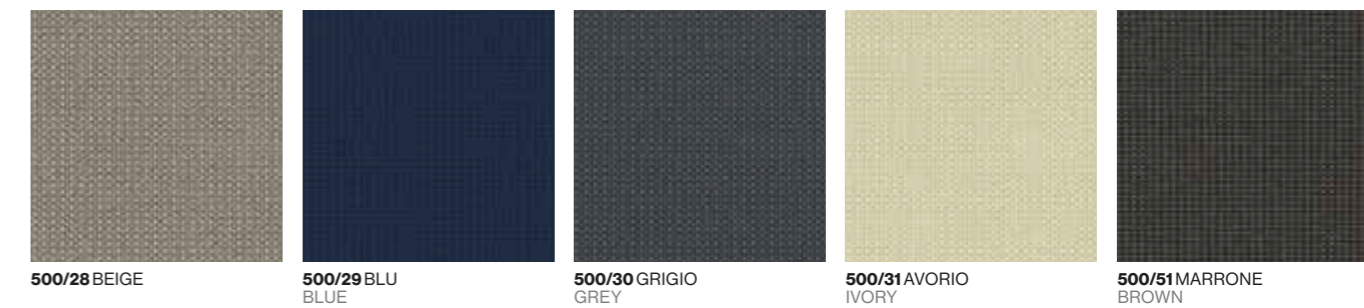



## TESSUTI STANDARD—STANDARD FABRICS

Per informazioni circa la composizione dei tessuti compresi in tale fascia e la specifica manutenzione si prega di far riferimento al sito web [www.emu.it](http://www.emu.it) o di rivolgersi a [info@emu.it](mailto:info@emu.it) oppure all'ufficio commerciale di competenza.

For information regarding the composition of fabrics in this range and their specific maintenance, please refer to the website [www.emu.it](http://www.emu.it), write to [info@emu.it](mailto:info@emu.it) or contact the respective sales office.

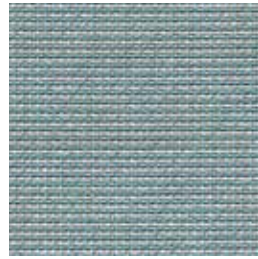

**900/01** CIELO  
SKY

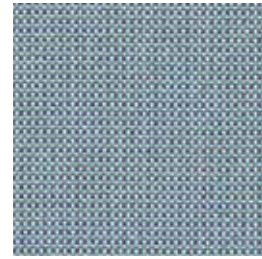

**900/02** MARE  
SEA

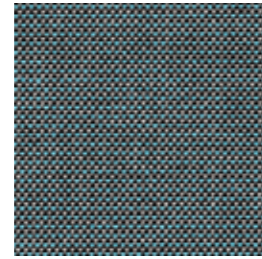

**900/03** NOTTE  
NIGHT

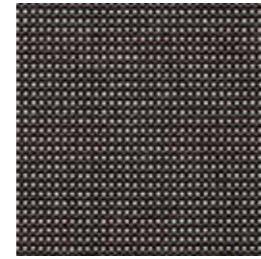

**900/05** NERO  
BLACK

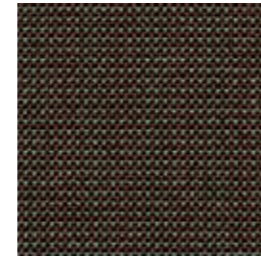

**900/06** BRONZO  
BRONZE

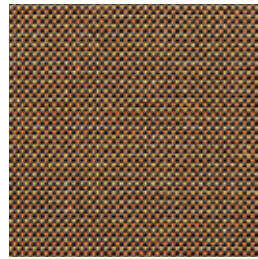

**900/07** AVANA  
CHESNUT

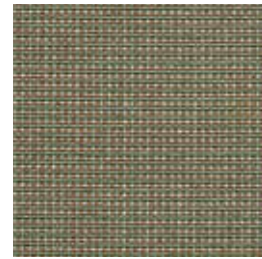

**900/08** SABBIA  
SAND

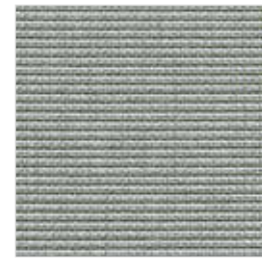

**900/09** SALVIA  
SAGE

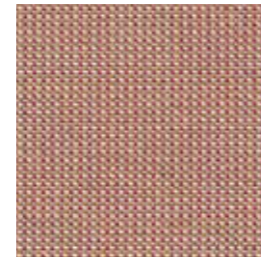

**900/13** SALMONE  
SALMON

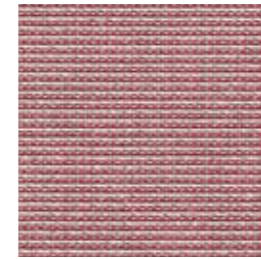

**900/14** CANDY



**900/17** PETROLIO  
PETROLEUM

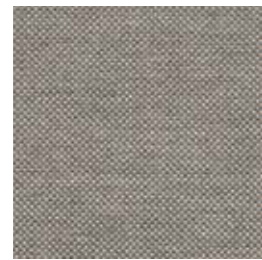

**900/18** MADREPERLA  
NACRE

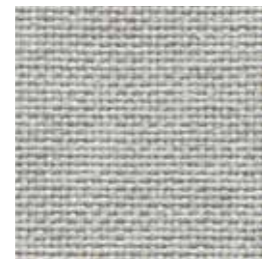

**900/71** BIANCO TRAMA STRETTA  
SMALL WEFT WHITE

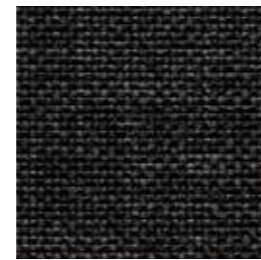

**900/75** MARRONE TRAMA STRETTA  
SMALL WEFT BROWN



**900/77** GRIGIO TRAMA STRETTA  
SMALL WEFT GREY



**900/79** BLU TRAMA STRETTA  
SMALL WEFT BLUE

## TESSUTI TAPPETI—RUGS FABRICS

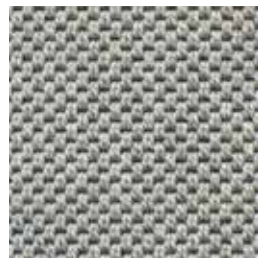

**900/40** GRIGIO CHIARO  
LIGHT GREY

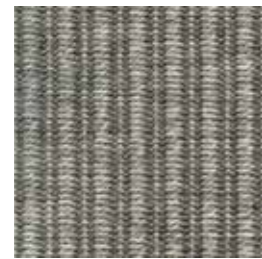

**900/41** GREIGE

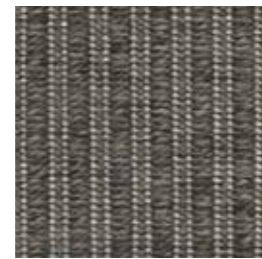

**900/42** MARRONE  
BROWN



**900/43** FANTASIA  
FANTASY

concept, progetto grafico,  
coordinamento / concept,  
graphic desing, supervision:  
**Studiopiù International**

foto / photos:

**Studiopiù International**  
Ettore Panichi  
Gian Domenico Troiano  
Paolo Veclani  
Luigi Benedetti

pag. 11 - Kombuis Restaurant, South Africa - project: Steyn Studio - ph: Adam Letch  
pag. 158 - Trullo Ermes & Atena, Italy - project: Rosaria Cocchia - ph: Casedifiaba  
pag. 204 - The Orange Cube, France - project: Jakob+MacFarlane - ph: Nicolas Borel  
pag. 205 - Bio's Kitchen, Italy - project: Studio Archinow! - ph: Giovanni De Sandre  
pag. 205 - Hotel Me Sitges, Spain - project: Lagranja Design - ph: Joan Guillamat  
pag. 239 - Sauna Löyly, Finland - project: Avanto Architects - ph: Mikko Ryhänen  
pag. 267 - Harrison Urby, USA - project: Concrete - ph: Ewout Huibers

stampa / printing:  
Graphic Masters

I prodotti illustrati sono soggetti ad una costante verifica dei particolari funzionali ed a una continua ricerca tecnologica sui trattamenti di finitura.  
I prodotti rappresentati nella presente pubblicazione, nonché le descrizioni e le caratteristiche tecniche riportate, sono indicativi e possono essere soggetti a modifiche da parte di EMU Group S.p.A.

The products illustrated are subject to constant revisions in terms of their functional details and continuous research goes into the finishing treatments applied.  
The products presented in this publication, as well as the descriptions and the specifications given are illustrative and are subject to change by EMU Group S.p.A.

Documento non contrattuale  
Non-contractual document

EMU Group S.p.A.  
MARSCIANO, PERUGIA, ITALIA / OTTOBRE 2021  
MARSCIANO, PERUGIA, ITALY / OCTOBER 2021



Organizzazione con Sistema di gestione qualità  
certificato UNI EN ISO 9001:2015 da CSI Spa



Il marchio della  
gestione forestale  
responsabile  
Richiedi prodotti certificati FSC®  
Look for our FSC® - certified products

emu.it

